

ICC PLAYING HANDBOOK 2019-20

THE OFFICIAL HANDBOOK FOR INTERNATIONAL
CRICKET PLAYERS, OFFICIALS AND ADMINISTRATORS



CONTENTS

- 01 KEY ICC CONTACTS
- 02 ICC MEMBER COUNTRIES
- 03 ICC MEN'S WORLD TEST CHAMPIONSHIP
PLAYING CONDITIONS
- 04 ICC MEN'S ONE-DAY INTERNATIONAL
PLAYING CONDITIONS
- 05 ICC MEN'S TWENTY20 INTERNATIONAL
PLAYING CONDITIONS
- 08 ICC WOMEN'S CHAMPIONSHIP
PLAYING CONDITIONS
- 09 ICC WOMEN'S TWENTY20 INTERNATIONAL
PLAYING CONDITIONS
- 13 ICC CODE OF CONDUCT FOR PLAYERS
AND PLAYER SUPPORT PERSONNEL
- 15 ICC ANTI-DISCRIMINATION CODE
FOR PARTICIPANTS
- 16 ICC ANTI-DOPING CODE
- 17 ICC ANTI-CORRUPTION CODE FOR PARTICIPANTS
- 18 ICC REGULATIONS FOR THE REVIEW
OF BOWLERS REPORTED WITH SUSPECTED
ILLEGAL BOWLING ACTIONS
- 19 CLOTHING AND EQUIPMENT RULES
AND REGULATIONS
- 20 ICC SAFEGUARDING REGULATIONS
- 21 OTHER ICC REGULATIONS

International Cricket Council, PO Box 500070,
Dubai, United Arab Emirates

Main switchboard + (971) 4382 8800

Main fax + (971) 4382 8600

General enquiry email enquiry@icc-cricket.com

Website www.icc-cricket.com

ICC KEY CONTACTS

ICC KEY CONTACTS

ICC CONTACT DETAILS

ICC DUBAI

Location	Sh Mohammed Bin Zayed Road Dubai Sports City, Street 69 Dubai, UAE
Address	Dubai Sports City P.O. Box 500070 Dubai, UAE
Main switchboard	+ (971) 4 382 8800
Fax	+ (971) 4 382 8600
Website	www.icc-cricket.com
General Enquiries	enquiry@icc-cricket.com
Media Enquiries	media@icc-cricket.com

CRICKET OPERATIONS

General Manager – Cricket	Geoff Allardice geoff.allardice@icc-cricket.com
Senior Cricket Operations Manager	Clive Hitchcock clive.hitchcock@icc-cricket.com
Senior Manager Umpires and Referees	Adrian Griffith adrian.griffith@icc-cricket.com

ANTI-CORRUPTION UNIT

ACU CONTACT DETAILS

ACU Hotline	+ (971) 56 545 8909
ACU Fax	+ (971) 4 340 4856
Enquiries	contactACU@icc-cricket.com
Media Enquiries	media@icc-cricket.com

All ACU media enquiries should be directed to the ICC Media Department.

ANTI-DOPING

ANTI-DOPING CONTACT DETAILS

Anti-Doping Hotline	+ (971) 50 554 5891 (24 hours)
Anti-Doping Enquiries	anti-doping@icc-cricket.com

ICC MEMBERS

ICC MEMBERS

FULL MEMBERS (12)	Afghanistan	India	South Africa
	Australia	Ireland	Sri Lanka
	Bangladesh	New Zealand	West Indies
	England	Pakistan	Zimbabwe
ASSOCIATE MEMBERS (92)	Argentina	Greece	Philippines
	Austria	Guernsey	PNG
	Bahamas	Hong Kong	Portugal
	Bahrain	Hungary	Qatar
	Belgium	Indonesia	Romania
	Belize	Iran	Russia
	Bermuda	Israel	Rwanda
	Botswana	Isle of Man	Samoa
	Bhutan	Italy	Saudi Arabia
	Brazil	Japan	Scotland
	Bulgaria	Jersey	Serbia
	Cameroon	Kenya	Seychelles
	Canada	Kuwait	Sierra Leone
	Cayman Islands	Lesotho	Singapore
	Chile	Luxembourg	Slovenia
	China	Malawi	South Korea
	Cook Islands	Malaysia	Spain
	Costa Rica	Maldives	St Helena
	Croatia	Mali	Suriname
	Cyprus	Malta	Swaziland
	Czech Republic	Mexico	Sweden
	Denmark	Mozambique	Tanzania
	Estonia	Myanmar	Thailand
	Falkland Islands	Namibia	Turkey
	Fiji	Nepal	Turks & Caicos
	Finland	Netherlands	UAE
	France	Nigeria	Uganda
	Gambia	Norway	USA
Germany	Oman	Vanuatu	
Ghana	Panama	Zambia	
Gibraltar	Peru		

Contact details for ICC Members can be found at the ICC website at www.icc-cricket.com/about/members

03

ICC MEN'S WORLD TEST CHAMPIONSHIP PLAYING CONDITIONS

Effective from 1 August 2019

ICC MEN'S WORLD TEST CHAMPIONSHIP PLAYING CONDITIONS

CONTENTS

1	THE PLAYERS	3.3
2	THE UMPIRES	3.6
3	THE SCORERS	3.12
4	THE BALL	3.12
5	THE BAT	3.13
6	THE PITCH	3.15
7	THE CREASES	3.16
8	THE WICKETS	3.17
9	PREPARATION AND MAINTENANCE OF THE PLAYING AREA	3.18
10	COVERING THE PITCH	3.21
11	INTERVALS	3.22
12	START OF PLAY; CESSATION OF PLAY	3.25
13	INNINGS	3.33
14	THE FOLLOW-ON	3.34
15	DECLARATION AND FORFEITURE	3.35
16	THE RESULT	3.35
17	THE OVER	3.39
18	SCORING RUNS	3.41
19	BOUNDARIES	3.44
20	DEAD BALL	3.47
21	NO BALL	3.49
22	WIDE BALL	3.52
23	BYE AND LEG BYE	3.54
24	FIELDER'S ABSENCE; SUBSTITUTES	3.55
25	BATSMAN'S INNINGS	3.57
26	PRACTICE ON THE FIELD	3.58
27	THE WICKET-KEEPER	3.59
28	THE FIELDER	3.61
29	THE WICKET IS DOWN	3.63
30	BATSMAN OUT OF HIS GROUND	3.64
31	APPEALS	3.65
32	BOWLED	3.66
33	CAUGHT	3.67
34	HIT THE BALL TWICE	3.68
35	HIT WICKET	3.69
36	LEG BEFORE WICKET	3.69

37	OBSTRUCTING THE FIELD	3.70
38	RUN OUT	3.71
39	STUMPED	3.72
40	TIMED OUT	3.73
41	UNFAIR PLAY	3.73
42	PLAYERS' CONDUCT	3.86

APPENDIX A DEFINITIONS

1	The match	3.89
2	Implements and equipment	3.90
3	The playing area	3.90
4	Positioning	3.90
5	Umpires and decision-making	3.91
6	Batsmen	3.93
7	Fielders	3.93
8	Substitutes and Concussion Replacements	3.93
9	Bowlers	3.94
10	The ball	3.94
11	Runs	3.95
12	The person	3.95
13	Off side / on side; in front of / behind the popping crease.	3.96

APPENDIX B EQUIPMENT

1	The Bat	3.97
2	The wickets	3.100
3	Wicket-keeping gloves	3.101

APPENDIX C THE VENUE

1	The pitch and the creases	3.102
2	Advertising on grounds, perimeter boards and sight-screens	3.103
3	Markings on outfield	3.103

APPENDIX D DECISION REVIEW SYSTEM (DRS)

1	General	3.104
2	Umpire Review	3.105
3	Player Review	3.108
4	Interpretation of Playing Conditions	3.118

APPENDIX E CALCULATIONS	3.119
-------------------------	-------

APPENDIX F USE OF ELECTRONIC COMMUNICATION EQUIPMENT	3.121
------------------------------------------------------	-------

PREAMBLE THE SPIRIT OF CRICKET

Cricket owes much of its appeal and enjoyment to the fact that it should be played not only according to the Laws (which are incorporated within these Playing Conditions), but also within the Spirit of Cricket.

The major responsibility for ensuring fair play rests with the captains, but extends to all players, match officials and, especially in junior cricket, teachers, coaches and parents.

Respect is central to the Spirit of Cricket.

Respect your captain, team-mates, opponents and the authority of the umpires.

Play hard and play fair.

Accept the umpire's decision.

Create a positive atmosphere by your own conduct, and encourage others to do likewise.

Show self-discipline, even when things go against you.

Congratulate the opposition on their successes, and enjoy those of your own team.

Thank the officials and your opposition at the end of the match, whatever the result.

Cricket is an exciting game that encourages leadership, friendship and teamwork, which brings together people from different nationalities, cultures and religions, especially when played within the Spirit of Cricket.

1 THE PLAYERS

1.1 Number of players

A match is played between two sides, each of eleven players, one of whom shall be captain.

1.2 Nomination and replacement of players

1.2.1 Each captain shall nominate 11 players plus a maximum of 6 substitute fielders in writing to the ICC Match Referee before the toss. Other than as set out in clause 1.2.7, no player (member of the playing eleven) may be changed after the nomination without the consent of the opposing captain.

1.2.2 Only those nominated as substitute fielders shall be entitled to act as substitute fielders during the match, unless the ICC Match Referee, in exceptional circumstances, allows subsequent additions.

1.2.3 All those nominated including those nominated as substitute fielders, as well as any Concussion Replacements, must be eligible to play for that particular team and by such nomination the nominees shall warrant that they are so eligible.

- 1.2.4 In addition, by their nomination, the nominees shall be deemed to have agreed to abide by all the applicable ICC Regulations pertaining to international cricket and in particular, the Clothing and Equipment Regulations, the Code of Conduct for Players and Player Support Personnel (hereafter referred to as the ICC Code of Conduct), the Anti-Racism Code for Players and Player Support Personnel, the Anti-Doping Code and the Anti-Corruption Code.
- 1.2.5 A player or player support personnel who has been suspended from participating in a match shall not, from the toss of the coin and for the remainder of the match thereafter:
- 1.2.5.1 Be nominated as, or carry out any of the duties or responsibilities of a substitute fielder, or
- 1.2.5.2 Enter any part of the playing area (which shall include the field of play and the area between the boundary and the perimeter boards) at any time, including any scheduled or unscheduled breaks in play.
- 1.2.6 A player who has been suspended from participating in a match shall be permitted from the toss of the coin and for the remainder of the match thereafter be permitted to enter the players' dressing room provided that the players' dressing room (or any part thereof) for the match is not within the playing area described in clause 1.2.5.2 above (for example, the player is not permitted to enter the on-field 'dug-out').
- 1.2.7 If a player sustains a concussion or suspected concussion as a result of a head or neck injury during the course of the relevant match, a Concussion Replacement may be permitted in the following circumstances:
- 1.2.7.1 the head or neck injury must have been sustained during play and within the playing area described in clause 1.2.5.2 above;
- 1.2.7.2 a concussion or suspected concussion must have been formally diagnosed by the Team Medical Representative;
- 1.2.7.3 the Team Medical Representative or Team Manager shall submit a Concussion Replacement Request to the ICC Match Referee on a standard form, which shall:
- 1.2.7.3.1 identify the player who has sustained the concussion or suspected concussion;
- 1.2.7.3.2 specify the incident in which the concussion or suspected concussion was sustained, including the time at which it occurred;
- 1.2.7.3.3 confirm that, following an examination, the Team Medical Representative believes or suspects that the player has sustained a concussion as a result of the incident specified in 1.2.7.3.2 above; and

- 1.2.7.3.4 identify the requested Concussion Replacement, who shall be a like-for-like replacement for the player who has sustained the concussion or suspected concussion.
- 1.2.7.4 The Concussion Replacement Request must be submitted within 36 hours of the incident specified in 1.2.7.3.2 if a Concussion Replacement is to be permitted.
- 1.2.8 The ICC Match Referee should ordinarily approve a Concussion Replacement Request if the replacement is a like-for-like player whose inclusion will not excessively advantage his team for the remainder of the match.
- 1.2.8.1 In assessing whether the nominated Concussion Replacement should be considered a like-for-like player, the ICC Match Referee should consider the likely role the concussed player would have played during the remainder of the match, and the normal role that would be performed by the nominated Concussion Replacement.
- 1.2.8.2 If the ICC Match Referee believes that the inclusion of the nominated Concussion Replacement, when performing their normal role, would excessively advantage their team, the Match Referee may impose such conditions upon the identity and involvement of the Concussion Replacement as he/she sees fit, in line with the overriding objective of facilitating a like-for-like replacement for the concussed player.
- 1.2.8.3 The ICC Match Referee may, in reviewing a Concussion Replacement Request made in accordance with clause 1.2.7.3, request any such further information as may be required in order to make the determination required under clauses 1.2.8.1 and 1.2.8.2.
- 1.2.9 The decision of the ICC Match Referee in relation to any Concussion Replacement Request shall be final and neither team shall have any right of appeal.
- 1.2.10 Once the Concussion Replacement has been approved by the ICC Match Referee, the replaced player shall play no further part in the match.
- 1.2.11 Both the Concussion Replacement and the replaced player shall be considered to have played in the match for records and statistical purposes.
- 1.3 Captain**
- 1.3.1 If at any time the captain is not available, a deputy shall act for him.
- 1.3.2 If a captain is not available to nominate the players, then any person associated with that team may act as his deputy to do so. See clause 1.2.
- 1.3.3 At any time after the nomination of the players, only a nominated player can act as deputy in discharging the duties and responsibilities of the captain as stated in these Playing Conditions, including at the toss. See clause 13.4(The toss).

1.4 Responsibility of captains

The captains are responsible at all times for ensuring that play is conducted within the Spirit of Cricket, as well as within these Playing Conditions.

2 THE UMPIRES**2.1 Appointment and attendance**

The following rules for the selection and appointment of Test Match umpires shall be followed as far as it is practicable to do so:

- 2.1.1 The following Match Officials are to be appointed for each Test Match;
- 2.1.1.1 One (1) ICC Match Referee, appointed by the ICC from the ICC Elite Panel of Referees or the ICC International Panel of Referees, who shall not be from the same country as the participating teams.
- 2.1.1.2 Two (2) on-field umpires, appointed by the ICC from the ICC Elite Panel of Umpires or the ICC International Panel of Umpires, who shall not be from the same country as the participating teams.
- 2.1.1.3 One (1) third umpire, who shall act as the emergency on-field umpire and officiate in regard to the DRS, appointed by the ICC from the ICC Elite Panel of Umpires or the ICC International Panel of Umpires, who shall not be from the same country as the participating teams.
- 2.1.1.3.1 The playing conditions governing the use of the DRS and the third umpire are included in Appendix D.
- 2.1.1.4 One (1) fourth umpire, who shall act as the emergency third umpire, appointed by the Home Board, from its nominees to the ICC International Panel of Umpires.
- 2.1.2 As early as possible before each Test Match, the ICC will advise the Home Board of the names of its appointees and the Home Board will advise the Manager of the visiting team of the names of all Match Officials.
- 2.1.3 Neither team will have a right of objection to the appointment of any umpire or match referee.
- 2.1.4 The umpires shall control the game as required by these Playing Conditions, with absolute impartiality and shall be present at the ground at least two hours before the scheduled start of the first day's play, and at least 1.5 hours before the scheduled start of each succeeding day's play.

2.2 Change of umpire

An umpire shall not be changed during the match, other than in exceptional circumstances, unless he/she is injured or ill.

2.3 Consultation with Home Board

Before the match the umpires shall consult with the Home Board to determine:

- 2.3.1 the balls to be used during the match. See clause 4 (The ball).
- 2.3.2 the hours of play and the times and durations of any agreed intervals.
- 2.3.3 which clock or watch and back-up time piece is to be used during the match.
- 2.3.4 the boundary of the field of play. See clause 19 (Boundaries).
- 2.3.5 the use of covers. See clause 10 (Covering the pitch).
- 2.3.6 any special conditions of play affecting the conduct of the match.

2.4 The wickets, creases and boundaries

Before the toss and during the match, the umpires shall satisfy themselves that

- 2.4.1 the wickets are properly pitched. See clause 8 (The wickets).
- 2.4.2 the creases are correctly marked. See clause 7 (The creases).
- 2.4.3 the boundary of the field of play complies with the requirements of clauses 19.1 (Determining the boundary of the field of play), 19.2 (Identifying and marking the boundary) and 19.3 (Restoring the boundary).

2.5 Conduct of the match, implements and equipment

Before the toss and during the match, the umpires shall satisfy themselves that

- 2.5.1 the conduct of the match is strictly in accordance with these Playing Conditions.
- 2.5.2 the implements used in the match conform to the following
- 2.5.2.1 clause 4 (The ball).
- 2.5.2.2 externally visible requirements of clause 5 (The bat) and paragraph 1 of Appendix B.
- 2.5.2.3 either clauses 8.2 (Size of stumps) and 8.3 (The bails).
- 2.5.3 no player uses equipment other than that permitted. See paragraph 2 of Appendix A. Note particularly therein the interpretation of 'protective helmet'.
- 2.5.4 the wicket-keeper's gloves comply with the requirements of clause 27.2 (Gloves).

2.6 Fair and unfair play

The umpires shall be the sole judges of fair and unfair play.

2.7 Fitness for play

- 2.7.1 It is solely for the umpires together to decide whether either conditions of ground, weather or light or exceptional circumstances mean that it would be dangerous or unreasonable for play to take place.
- Conditions shall not be regarded as either dangerous or unreasonable merely because they are not ideal.
- The fact that the grass and the ball are wet does not warrant the ground conditions being regarded as unreasonable or dangerous.
- 2.7.2 Conditions shall be regarded as dangerous if there is actual and foreseeable risk to the safety of any player or umpire.
- 2.7.3 Conditions shall be regarded as unreasonable if, although posing no risk to safety, it would not be sensible for play to proceed.
- 2.7.4 If the umpires consider the ground is so wet or slippery as to deprive the bowler of a reasonable foothold, the fielders of the power of free movement, or the batsmen of the ability to play their strokes or to run between the wickets, then these conditions shall be regarded as so bad that it would be dangerous and unreasonable for play to take place.

2.8 Suspension of play in dangerous or unreasonable circumstances

- 2.8.1 All references to ground include the pitch. See clause 6.1 (Area of pitch).
- 2.8.2 If at any time the umpires together agree that the conditions of ground, weather or light, or any other circumstances are dangerous or unreasonable, they shall immediately suspend play, or not allow play to start or to recommence. The decision as to whether conditions are so bad as to warrant such action is one for the umpires alone to make, following consultation with the ICC Match Referee.
- 2.8.3 If circumstances are warranted, the umpires shall stop play and instruct the Ground Authority to take whatever action they can and use whatever equipment is necessary to remove as much dew as possible from the outfield when conditions become unreasonable or dangerous. The umpires may also instruct the ground staff to take such action during scheduled and unscheduled breaks in play.
- 2.8.4 The umpires shall disregard any shadow on the pitch from the stadium or from any permanent object on the ground.
- 2.8.5 Light Meters
- It is the responsibility of the ICC to supply light meters to the match officials to be used in accordance with these playing conditions.
- 2.8.5.1 All light meters shall be uniformly calibrated.
- 2.8.5.2 The umpires shall be entitled to use light meter readings as a guideline for determining whether the light is fit for play in accordance with the criteria set out in clause 2.8.2 above.

- 2.8.5.3 Light meter readings may accordingly be used by the umpires:
- 2.8.5.3.1 To determine whether there has been at any stage a deterioration or improvement in the light.
- 2.8.5.3.2 As benchmarks for the remainder of the match.
- 2.8.6 Use of artificial lights
- If in the opinion of the umpires, natural light is deteriorating to an unfit level, they shall authorize the Ground Authority to use the available artificial lighting so that the match can commence or continue in acceptable conditions.
- In the event of power failure or lights malfunction, the provisions relating to the delay or interruption of play due to bad weather or light shall apply.
- Home Boards may, prior to the commencement of the series, seek the approval of the ICC to amend this playing condition to provide that artificial lights will not be used at specific venues.
- For day/night Test matches, the latest times at which the floodlights are to be switched on each day shall be decided by the Home Board prior to the match and the ICC Match Referee shall be duly informed.
- 2.8.7 When there is a suspension of play it is the responsibility of the umpires to monitor conditions. They shall make inspections as often as appropriate, unaccompanied by any players or officials. Immediately the umpires together agree that the conditions are no longer dangerous or unreasonable they shall call upon the players to resume play.
- 2.8.8 The safety of all persons within the ground is of paramount importance to the ICC. In the event that of any threatening circumstance, whether actual or perceived (including for example weather, pitch invasions, act of God, etc.), then the umpires, on the advice of the ICC Match Referee, should suspend play and all players and officials should immediately be asked to leave the field of play in a safe and orderly manner and to relocate to a secure and safe area (depending on each particular threat) pending the satisfactory passing or resolution of such threat or risk to the reasonable satisfaction of the umpires, the ICC Match Referee, the head of the relevant Ground Authority, the head of ground security and/or the police as the circumstances may require.
- 2.8.9 Where play is suspended under clause 2.8.8 above the decision to abandon or resume play shall be the responsibility of the ICC Match Referee who shall act only after consultation with the head of ground security and the police.

2.9 Position of umpires

The umpires shall stand where they can best see any act upon which their decision may be required.

Subject to this over-riding consideration, the bowler's end umpire shall stand in a position so as not to interfere with either the bowler's run-out or the striker's view.

The striker's end umpire may elect to stand on the off side instead of the on side of the pitch, provided he informs the captain of the fielding side, the striker and the other umpire.

2.10 Umpires changing ends

The umpires shall change ends after each side has had one completed innings. See clause 13.3 (Completed innings).

2.11 Disagreement and dispute

Where there is disagreement or dispute about any matter, the umpires together shall make the final decision. See also clause 31.6 (Consultation by umpires).

2.12 Umpire's decision

An umpire may alter any decision provided that such alteration is made promptly. This apart, an umpire's decision, once made, is final.

2.13 Signals

2.13.1 The following code of signals shall be used by umpires.

2.13.1.1 Signals made while the ball is in play

No ball - by extending one arm horizontally.

Out - by raising an index finger above the head. (If not out, the umpire shall call Not out.)

Wide - by extending both arms horizontally.

Dead ball - by crossing and re-crossing the wrists below the waist.

2.13.1.2 When the ball is dead, the bowler's end umpire shall repeat the signals in clause 2.13.1.1, with the exception of the signal for Out, to the scorers.

2.13.1.3 The signals listed below shall be made to the scorers only when the ball is dead.

Boundary 4 - by waving an arm from side to side finishing with the arm across the chest

Boundary 6 - by raising both arms above the head.

Bye - by raising an open hand above the head.

Commencement of last hour - by pointing to a raised wrist with the other hand.

Five Penalty runs awarded to the batting side - by repeated tapping of one shoulder with the opposite hand.

Five Penalty runs awarded to the fielding side - by placing one hand on the opposite shoulder.

Leg bye - by touching a raised knee with the hand.

New ball - by holding the ball above the head.

Revoke last signal - by touching both shoulders, each with the opposite hand.

Short run - by bending one arm upwards and touching the nearer shoulder with the tips of the fingers.

The following signal is for Level 4 player conduct offences. The signal has two parts, both of which should be acknowledged separately by the scorers.

Level 4 conduct

Part 1 - by putting one arm out to the side of the body and repeatedly raising it and lowering it.

Part 2 - by raising an index finger, held at shoulder height, to the side of the body.

2.13.1.4 All the signals in clause 2.13.1.3 are to be made by the bowler's end umpire except that for Short run, which is to be signalled by the umpire at the end where short running occurs. However, the bowler's end umpire shall be responsible both for the final signal of Short run to the scorers and, if more than one run is short, for informing them as to the number of runs to be recorded.

2.13.2 The umpire shall wait until each signal to the scorers has been separately acknowledged by a scorer before allowing play to proceed.

If several signals are to be used, they should be given in the order that the events occurred.

2.14 Informing the umpires

Wherever the umpires are to receive information from captains or other players under these Playing Conditions, it will be sufficient for one umpire to be so informed and for him/her to inform the other umpire.

2.15 Correctness of scores

Consultation between umpires and scorers on doubtful points is essential. The umpires shall, throughout the match, satisfy themselves as to the correctness of the number of runs scored, the wickets that have fallen and, where appropriate, the number of overs bowled.

The umpires shall ensure that they are able to contact the scorers at any time during the match and at its conclusion to address any issues relating to the correctness of scores.

3 THE SCORERS**3.1 Appointment of scorers**

Two scorers shall be appointed to record all runs scored, all wickets taken and, where appropriate, number of overs bowled.

3.2 Correctness of scores

The scorers shall frequently check to ensure that their records agree and consult with the umpires if necessary. See clause 2.15 (Correctness of scores).

3.3 Acknowledging signals

The scorers shall accept all instructions and signals given to them by the umpires and shall immediately acknowledge each separate signal.

4 THE BALL**4.1 Weight and size**

The ball, when new, shall weigh not less than 5.5 ounces/155.9 g, nor more than 5.75 ounces/163 g, and shall measure not less than 8.81 in/22.4 cm, nor more than 9 in/22.9 cm in circumference.

4.2 Approval and control of balls

4.2.1 The Home Board shall provide cricket balls of an approved standard for Test cricket and spare used balls for changing during a match, which shall also be of the same brand. Note: The Home Board shall be required to advise the Visiting Board of the brand of ball to be used in the match(es) at least 30 days prior to the start of the match(es).

4.2.2 The fielding captain or his nominee may select the ball with which he wishes to bowl from the supply provided by the Home Board. The fourth umpire shall take a box containing at least 6 new balls to the dressing room and supervise the selection of the ball.

4.2.3 The umpires shall retain possession of the match ball(s) throughout the duration of the match when play is not actually taking place.

4.2.4 During play umpires shall periodically and irregularly inspect the condition of the ball and shall retain possession of it at the fall of a wicket, a drinks interval, or any other disruption in play.

4.3 New ball

A new ball shall be used at the start of each innings.

4.4 New ball available after 80 overs

The captain of the fielding side may demand a new ball when the number of overs, excluding any part overs, bowled with the old one is equal to or greater than 80 overs. The umpire shall inform the other umpire and indicate to the batsmen and the scorers whenever a new ball is taken into play.

4.5 Ball lost or becoming unfit for play

If, during play, the ball cannot be found or recovered or the umpires agree that it has become unfit for play through normal use, the umpires shall replace it with a ball which has had wear comparable with that which the previous ball had received before the need for its replacement. When the ball is replaced, the umpires shall inform the batsmen and the fielding captain.

However, if the ball needs to be replaced after 110 overs for any of the reasons above, it shall be replaced by a new ball. If the ball is to be replaced, the umpires shall inform the batsmen, the fielding captain and the scorers.

5 THE BAT**5.1 The bat**

5.1.1 The bat consists of two parts, a handle and a blade.

5.1.2 The basic requirements and measurements of the bat are set out in this clause with detailed specifications in paragraph 1 of Appendix B.

5.2 The handle

5.2.1 The handle is to be made principally of cane and/or wood.

5.2.2 The part of the handle that is wholly outside the blade is defined to be the upper portion of the handle. It is a straight shaft for holding the bat.

5.2.3 The upper portion of the handle may be covered with a grip as defined in paragraph 1.2.2 of Appendix B.

5.3 The blade

5.3.1 The blade comprises the whole of the bat apart from the handle as defined in clause 5.2 and in paragraph 1.3 of Appendix B.

5.3.2 The blade shall consist solely of wood.

5.4 Protection and repair

Subject to the specifications in paragraph 1.4 of Appendix B and providing clause 5.5 is not contravened,

5.4.1 solely for the purposes of

either protection from surface damage to the face, sides and shoulders of the blade

or repair to the blade after surface damage,

material that is not rigid, either at the time of its application to the blade or subsequently, may be placed on these surfaces.

5.4.2 for repair of the blade after damage other than surface damage

5.4.2.1 solid material may be inserted into the blade.

5.4.2.2 The only material permitted for any insertion is wood with minimal essential adhesives.

- 5.4.3 to prevent damage to the toe, material may be placed on that part of the blade but shall not extend over any part of the face, back or sides of the blade.

5.5 Damage to the ball

- 5.5.1 For any part of the bat, covered or uncovered, the hardness of the constituent materials and the surface texture thereof shall not be such that either or both could cause unacceptable damage to the ball.
- 5.5.2 Any material placed on any part of the bat, for whatever purpose, shall similarly not be such that it could cause unacceptable damage to the ball.
- 5.5.3 For the purpose of this clause, unacceptable damage is any change that is greater than normal wear and tear caused by the ball striking the uncovered wooden surface of the blade.

5.6 Contact with the ball

In these clauses,

- 5.6.1 reference to the bat shall imply that the bat is held in the batsman's hand or a glove worn on his hand, unless stated otherwise.
- 5.6.2 contact between the ball and any of 5.6.2.1 to 5.6.2.4
- 5.6.2.1 the bat itself
- 5.6.2.2 the batsman's hand holding the bat
- 5.6.2.3 any part of a glove worn on the batsman's hand holding the bat
- 5.6.2.4 any additional materials permitted under 5.4 shall be regarded as the ball striking or touching the bat or being struck by the bat.

5.7 Bat size limits

- 5.7.1 The overall length of the bat, when the lower portion of the handle is inserted, shall not be more than 38 in/96.52 cm.
- 5.7.2 The blade of the bat shall not exceed the following dimensions:
Width: 4.25in / 10.8 cm
Depth: 2.64in / 6.7 cm
Edges: 1.56in / 4.0cm.
Furthermore, it should also be able to pass through a bat gauge as described in paragraph 1.6 of Appendix B.
- 5.7.3 The handle shall not exceed 52% of the overall length of the bat.
- 5.7.4 The material permitted for covering the blade in clause 5.4.1 shall not exceed 0.04 in/0.1 cm in thickness.
- 5.7.5 The maximum permitted thickness of protective material placed on the toe of the blade is 0.12 in/0.3 cm.

5.8 Categories of bat

- 5.8.1 Type A bats conform to clause 5.1 to 5.7 inclusive.
- 5.8.2 Only Type A bats may be used in Test matches.

6 THE PITCH

6.1 Area of pitch

The pitch is a rectangular area of the ground 22 yards/20.12 m in length and 10 ft/3.05 m in width. It is bounded at either end by the bowling creases and on either side by imaginary lines, one each side of the imaginary line joining the centres of the two middle stumps, each parallel to it and 5 ft/1.52 m from it. If the pitch is next to an artificial pitch which is closer than 5 ft/1.52 m from the middle stumps, the pitch on that side will extend only to the junction of the two surfaces. See clauses 8.1 (Description, width and pitching) and 7.2 (The bowling crease).

6.2 Fitness of pitch for play

The umpires shall be the sole judges of the fitness of the pitch for play. See clauses 2.7 (Fitness for play), 2.8 (Suspension of play in dangerous or unreasonable conditions) and 6.4 (changing the pitch).

6.3 Selection and preparation

Before the match, the Ground Authority shall be responsible for the selection and preparation of the pitch. During the match, the umpires shall control its use and maintenance.

- 6.3.1 The Ground Authority shall ensure that during the period prior to the start of play and during intervals, the pitch area shall be roped off so as to prevent unauthorised access. (The pitch area shall include an area at least 2 metres beyond the rectangle made by the crease markings at both ends of the pitch).
- 6.3.2 The fourth umpire shall ensure that, prior to the start of play and during any intervals, only authorised staff, the ICC match officials, players, team coaches and authorised television personnel shall be allowed access to the pitch area. Such access shall be subject to the following limitations:
- 6.3.2.1 Only captains and team coaches may walk on the actual playing surface of the pitch area (outside of the crease markings).
- 6.3.2.2 Access to the pitch area by television personnel shall be restricted to one camera crew (including one or two television commentators) of the official licensed television broadcaster(s) (but not news crews).
- 6.3.2.3 No spiked footwear shall be permitted.
- 6.3.2.4 No one shall be permitted to bounce a ball on the pitch, strike it with a bat or cause damage to the pitch in any other way.
- 6.3.2.5 Access shall not interfere with pitch preparation.
- 6.3.3 In the event of any dispute, the ICC Match Referee will rule and his ruling will be final.

6.4 Changing the pitch

- 6.4.1 If the on-field umpires decide that it is dangerous or unreasonable for play to continue on the match pitch, they shall stop play and immediately advise the ICC Match Referee.
- 6.4.2 The on-field umpires and the ICC Match Referee shall then consult with both captains.
- 6.4.3 If the captains agree to continue, play shall resume.
- 6.4.4 If the decision is not to resume play, the on-field umpires together with the ICC Match Referee shall consider whether the existing pitch can be repaired and the match resumed from the point it was stopped. In considering whether to authorise such repairs, the ICC Match Referee must consider whether this would place either side at an unfair advantage, given the play that had already taken place on the dangerous pitch.
- 6.4.5 If the decision is that the existing pitch cannot be repaired, then the match is to be abandoned as a draw.
- 6.4.6 If the abandonment occurs on the first scheduled day of the match, the ICC Match Referee shall consult with the Home Board with the objective of finding a way for a new match (including a new nomination of teams and toss) to commence on the same date and venue. Such a match may be played either on the repaired pitch or on another pitch, subject to the ICC Match Referee and the relevant Ground Authority both being satisfied that the new pitch will be of the required Test standard. The playing time lost between the scheduled start time of the original match and the actual start time of the new match will be covered by the provisions of clause 12.
- 6.4.7 If it is not possible to start a new match on the scheduled first day of the original match, the relevant officials from the participating Boards shall agree on whether the match can be replayed within the existing tour schedule.
- 6.4.8 Throughout the above decision making processes, the ICC Match Referee shall keep informed both captains and the head of the Ground Authority. The head of the Ground Authority shall ensure that suitable and prompt public announcements are made.

6.5 Non-turf pitches

All Test matches shall be played on natural turf pitches. The use of PVA and other adhesives in the preparation of pitches is not permitted.

7 THE CREASES**7.1 The creases**

The positions of a bowling crease, a popping crease and two return creases shall be marked by white lines, as set out in clauses 7.2, 7.3 and 7.4, at each end of the pitch. See paragraph 1 of Appendix C.

7.2 The bowling crease

The bowling crease, which is the back edge of the crease marking, is the line that marks the end of the pitch, as in clause 6.1 (Area of pitch). It shall be 8 ft 8 in/2.64 m in length.

7.3 The popping crease

The popping crease, which is the back edge of the crease marking, shall be in front of and parallel to the bowling crease and shall be 4 ft/1.22 m from it. The popping crease shall be marked to a minimum of 15 yards/13.71 m on either side of the imaginary line joining the centres of the two middle stumps and shall be considered to be unlimited in length.

7.4 The return creases

The return creases, which are the inside edges of the crease markings, shall be at right angles to the popping crease at a distance of 4 ft 4 in/1.32 m either side of the imaginary line joining the centres of the two middle stumps. Each return crease shall be marked from the popping crease to a minimum of 8 ft/2.44 m behind it and shall be considered to be unlimited in length.

8 THE WICKETS**8.1 Description, width and pitching**

Two sets of wickets shall be pitched opposite and parallel to each other in the centres of the bowling creases. Each set shall be 9 in/22.86 cm wide and shall consist of three wooden stumps with two wooden bails on top. See paragraph 2 of Appendix B.

8.2 Size of stumps

The tops of the stumps shall be 28 in/71.12 cm above the playing surface and shall be dome shaped except for the bail grooves. The portion of a stump above the playing surface shall be cylindrical apart from the domed top, with circular section of diameter not less than 1.38 in/3.50 cm nor more than 1.5 in/3.81 cm. See paragraph 2 of Appendix B.

For televised matches the Home Board may provide a slightly larger cylindrical stump to accommodate the stump camera. When the larger stump is used, all three stumps must be exactly the same size.

8.3 The bails

- 8.3.1 The bails, when in position on top of the stumps,
- shall not project more than 0.5 in/1.27 cm above them.
 - shall fit between the stumps without forcing them out of the vertical.
- 8.3.2 Each bail shall conform to the following specifications (see paragraph 2 of Appendix B):
- Overall length 4.31 in/10.95 cm
 - Length of barrel 2.13 in /5.40 cm
 - Longer spigot 1.38 in/3.50 cm
 - Shorter spigot 0.81 in/2.06 cm.
- 8.3.3 The two spigots and the barrel shall have the same centre line.
- 8.3.4 Devices aimed at protecting player safety by limiting the distance that a bail can travel off the stumps will be allowed, subject to the approval of the Home Board and the ICC.

8.4 Dispensing with bails

The umpires may agree to dispense with the use of bails, if necessary. If they so agree then no bails shall be used at either end. The use of bails shall be resumed as soon as conditions permit. See clause 29.4 (Dispensing with bails).

8.5 LED Wickets

The use of approved LED Wickets is permitted. Refer also to paragraphs 3.8.1.6 and 4.2 of Appendix D.

9 PREPARATION AND MAINTENANCE OF THE PLAYING AREA**9.1 Rolling**

The pitch shall not be rolled during the match except as permitted in clauses 9.1.1 and 9.1.2.

9.1.1 Frequency and duration of rolling

During the match the pitch may be rolled at the request of the captain of the batting side, for a period of not more than 7 minutes, before the start of each innings, other than the first innings of the match, and before the start of each subsequent day's play. See clause 9.1.4.

9.1.2 Rolling after a delayed start

In addition to the rolling permitted above, if, after the toss and before the first innings of the match, the start is delayed, the captain of the batting side may request that the pitch be rolled for not more than 7 minutes. However, if the umpires together agree that the delay has had no significant effect on the state of the pitch, they shall refuse such request for rolling of the pitch.

9.1.3 Choice of rollers

If there is more than one roller available the captain of the batting side shall choose which one is to be used.

9.1.4 Timing of permitted rolling

The rolling permitted (maximum 7 minutes) before play begins on any day shall be started not more than 30 minutes before the time scheduled or rescheduled for play to begin. The captain of the batting side may, however, delay the start of such rolling until not less than 10 minutes before the time scheduled or rescheduled for play to begin.

The following shall apply in addition to clause 9.1:

- 9.1.5** Prior to the scheduled time for the toss, the artificial drying of the pitch and outfield shall be at the discretion of the Ground Authority. Thereafter and throughout the match the drying of the outfield may be undertaken at any time by the Ground Authority, but the drying of the affected area of the pitch shall be carried out only on the instructions and under the supervision of the umpires. The umpires shall be empowered to have the pitch dried without reference to the captains at any time they are of the opinion that it is unfit for play.

- 9.1.6** The umpires may instruct the Ground Authority to use any available equipment, including any roller for the purpose of drying the pitch and making it fit for play.

- 9.1.7** An absorbent roller may be used to remove water from the covers including the cover on the match pitch.

9.2 Clearing debris from the pitch

- 9.2.1** The pitch shall be cleared of any debris

9.2.1.1 before the start of each day's play. This shall be after the completion of mowing and before any rolling, not earlier than 30 minutes nor later than 10 minutes before the time or any rescheduled time for start of play.

9.2.1.2 between innings. This shall precede rolling if any is to take place.

9.2.1.3 at all intervals for meals.

- 9.2.2** The clearance of debris in clause 9.2.1 shall be done by sweeping, except where the umpires consider that this may be detrimental to the surface of the pitch. In this case the debris must be cleared from that area by hand, without sweeping.

- 9.2.3** In addition to clause 9.2.1, debris may be cleared from the pitch by hand, without sweeping, before mowing and whenever either umpire considers it necessary.

9.3 Mowing

- 9.3.1** Responsibility for mowing

9.3.1.1 All mowings which are carried out before the match shall be the sole responsibility of the Ground Authority.

9.3.1.2 All subsequent mowings shall be carried out under the supervision of the umpires.

- 9.3.2** The pitch and outfield

In order that throughout the match the ground conditions should be as nearly the same for both sides as possible, both the pitch and the outfield shall be mown on each day of the match on which play is expected to take place, if ground and weather conditions permit.

If, for reasons other than conditions of ground or weather, complete mowing of the outfield is not possible, the Ground Authority shall notify the captains and umpires of the procedure to be adopted for such mowing during the match.

- 9.3.3** Timing of mowing

9.3.3.1 Mowing of the pitch on any day shall be completed not later than 30 minutes before the time scheduled or rescheduled for play to begin on that day, before any sweeping prior to rolling. If necessary, debris may be removed from the pitch before mowing, by hand, without sweeping. See clause 9.2.3.

- 9.3.3.2 Mowing of the outfield on any day shall be completed not later than 15 minutes before the time scheduled or rescheduled for play to begin on that day.

9.4 Watering the pitch

The pitch shall not be watered during the match.

9.5 Re-marking creases

Creases shall be re-marked whenever either umpire considers it necessary.

9.6 Maintenance of footholes

The umpires shall ensure that the holes made by the bowlers and batsmen are cleaned out and dried whenever necessary to facilitate play.

The umpires shall allow, if necessary, the returving of footholes made by the bowlers in their delivery strides, or the use of quick-setting fillings for the same purpose.

In addition, the umpires shall see that wherever possible and whenever it is considered necessary, action is taken during all intervals in play to do whatever is practicable to improve the bowler's footholes. As soon as possible after the conclusion of each day's play, bowler's footholes will be repaired.

9.7 Securing of footholds and maintenance of pitch

During play, umpires shall allow the players to secure their footholds by the use of sawdust provided that no damage to the pitch is caused and that clause 41 (Unfair play) is not contravened.

9.8 Watering the outfield

The watering of the outfield will be permitted during the match subject to the following:

- 9.8.1 Such watering shall only be possible if the "watering plan" is requested by the Ground Authority and approved by the umpires before the match has started. Once the match has started, any such request will not be considered.
- 9.8.2 The consent of the captains is not required, but the umpires shall advise both captains and the ICC Match Referee before the start of the match on what has been agreed.
- 9.8.3 The watering shall occur as soon as possible after the conclusion of the day's play.
- 9.8.4 The watering shall only be carried out to the extent that it is necessary to retain the good condition of the outfield.
- 9.8.5 The square and bowlers' run ups will be adequately covered prior to any watering taking place.
- 9.8.6 All ongoing matters of interpretation and implementation of watering requirements and regulations shall be resolved between the umpires and Ground Authority, but with the umpires retaining ultimate discretion over whether to approve any watering.

9.9 Protection and preparation of adjacent pitches during matches

The protection (by way of an appropriate cover) and preparation of pitches which are adjacent to the match pitch will be permitted during the match subject to the following:

- 9.9.1 Such measures will only be possible if requested by the Ground Authority and approved by the umpires before the start of the match.
- 9.9.2 Approval should only be granted where such measures are unavoidable and will not compromise the safety of the players or their ability to execute their actions with complete freedom.
- 9.9.3 The preparation work shall be carried out under the supervision of the fourth umpire.
- 9.9.4 Any necessary watering shall be carried out only to the extent necessary for such preparations and shall not be permitted in circumstances which may in any way affect the match pitch.
- 9.9.5 The consent of the captains is not required but the umpires shall advise both captains and the ICC Match Referee before the start of the match on what has been agreed.

10 COVERING THE PITCH

10.1 Before the match

The use of covers before the match is the responsibility of the Ground Authority and may include full covering if required.

The pitch shall be entirely protected against rain up to the commencement of play.

However, the Ground Authority shall grant suitable facility to the captains to inspect the pitch before the nomination of their players and to the umpires to discharge their duties as laid down in clauses 2 (The umpires), 6 (The pitch), 7 (The creases), 8 (The wickets), and 9 (Preparation and maintenance of the playing area).

10.2 During the match

The pitch shall be entirely protected against rain up to the commencement of play each day, and for the duration of the period of the match. It shall be wholly covered at the termination of each day's play or providing the weather is fine, within a period of two hours thereafter.

The covers must totally protect the pitch and also the pitch surroundings, to a minimum of 5 metres either side of the pitch, and any worn or soft areas in the outfield.

The bowlers' run-ups shall be covered during inclement weather, in order to keep them dry, to a distance of at least 10 x 10 metres.

10.3 Removal of covers

All covers (including "hessian" or "scrim" covers used to protect the pitch against the sun) shall be removed not later than 2 ½ hours before the scheduled start of play provided it is not raining at the time, but the pitch will be covered again if rain falls prior to the commencement of play.

11 INTERVALS**11.1 An interval**

- 11.1.1 The following shall be classed as intervals.
- The period between close of play on one day and the start of the next day's play.
 - Intervals between innings.
 - Intervals for meals.
 - Intervals for drinks.
 - Any other agreed interval.
- 11.1.2 Only these intervals shall be considered as scheduled breaks for the purposes of clause 24.2.6.

11.2 Duration of intervals

- 11.2.1 An interval for lunch or tea shall be of the duration detailed below, taken from the call of Time before the interval until the call of Play on resumption after the interval.
- 11.2.1.1 Lunch Interval: The interval shall be of 40 minutes duration.
- 11.2.1.2 Tea Interval: The interval shall be of 20 minutes duration.
- 11.2.1.3 Home Boards, with the consent of the visiting Board, may seek the approval of the ICC to amend the duration of these two intervals, provided the combined scheduled duration of the two intervals shall be equal to 60 minutes.
- 11.2.2 An interval between innings shall be 10 minutes, commencing from the close of an innings until the call of Play for the start of the next innings. See, however, clauses 11.3, 11.5 and 11.6.

11.3 Allowance for interval between innings

- In addition to the provisions of clauses 11.5 and 11.6,
- 11.3.1 if an innings ends when 10 minutes or less remains before the time agreed for close of play, or when there are less than 2 overs remaining to complete the minimum over requirement on any day, whichever is applicable, there shall be no further play on that day. No change shall be made to the time for the start of play on the following day on account of the 10 minute interval between innings.
- 11.3.2 if a captain declares an innings closed during an interruption in play of more than 10 minutes duration, provided that at least 10 minutes remains of the interruption, no adjustment shall be made to the time for resumption of play on account of the 10 minute interval between innings, which shall be considered as included in the interruption. If less than 10 minutes remains of the interruption when the captain declares the innings closed, or forfeits an innings, the next innings shall commence 10 minutes after the declaration or forfeiture is made.

- 11.3.3 if a captain declares an innings closed during any interval other than an interval for drinks, provided that at least 10 minutes remains of the interval, the interval shall be of the agreed duration and shall be considered to include the 10 minute interval between innings. If less than 10 minutes remains of the interval when the captain declares the innings closed, or forfeits an innings, the interval shall be extended as necessary and the next innings shall commence 10 minutes after the declaration or forfeiture is made.

11.4 Changing agreed times of intervals

If, at any time during the match,

- either playing time is lost through adverse conditions of ground, weather or light or in exceptional circumstances,
- or the players have occasion to leave the field other than at a scheduled interval,

the time of the lunch interval or of the tea interval may be changed if the two umpires and both captains so agree, providing the requirements of clauses 11.2 and 11.5, 11.6, 11.7 and 11.8.3 are not contravened.

11.5 Changing agreed time for lunch interval

- 11.5.1 If an innings ends when 10 minutes or less remains before the agreed time for lunch, the interval shall be taken immediately. It shall be of the agreed duration and shall be considered to include the 10 minute interval between innings.
- 11.5.2 If because of adverse conditions of ground, weather or light, or in exceptional circumstances, a stoppage occurs when 10 minutes or less remains before the agreed time for lunch, then, whether or not agreement is reached in the circumstances of clause 11.4, the interval shall be taken immediately. It shall be of the agreed duration. Play shall resume at the end of this interval or as soon after as conditions permit.
- 11.5.3 If the players have occasion to leave the field for any reason when more than 10 minutes remains before the agreed time for lunch then, unless the umpires and captains together agree to alter it, lunch shall be taken at the agreed time.

11.6 Changing agreed time for tea interval

- 11.6.1 If an innings ends when 30 minutes or less remains before the agreed time for tea, the interval shall be taken immediately. It shall be of the agreed duration and shall be considered to include the 10 minute interval between innings.
- 11.6.2 If, when 30 minutes remains before the agreed time for tea, an interval between innings is already in progress, play shall resume at the end of the 10 minute interval, if conditions permit.

- 11.6.3 If, because of adverse conditions of ground, weather or light, or in exceptional circumstances, a stoppage occurs when 30 minutes or less remains before the agreed time for tea, then unless there is an agreement to change the time for tea, as permitted in clause 11.4, the interval shall be taken immediately. The interval shall be of the agreed duration. Play shall resume at the end of the interval or as soon after as conditions permit.
- 11.6.4 If a stoppage is already in progress when 30 minutes remains before the agreed time for tea, clause 11.4 shall apply.

11.7 Lunch or tea interval – 9 wickets down

For the lunch interval and for the tea interval

- If either, 9 wickets are already down when 3 minutes remains to the scheduled time for the interval,
- or, the 9th wicket falls within this 3 minutes, or at any time up to and including the final ball of the over in progress at the scheduled time for the interval,

then the provisions of clause 12.5.2 shall not apply and the interval will not be taken until the end of the over that is in progress 30 minutes after the originally agreed time for the interval, unless the players have cause to leave the field of play or the innings is completed earlier.

However, if at the conclusion of this additional 30 minutes, if a small number of runs are required to win the match, and both captains wish to continue playing in order to achieve a definite result, play will continue until either the match concludes or the players have cause to leave the field for any other reason.

For the purposes of this section of the Playing Conditions, the retirement of a batsman is not to be considered equivalent to the fall of a wicket.

11.8 Intervals for drinks

- 11.8.1 Drinks intervals shall be scheduled. Each interval shall be kept as short as possible and in any case shall not exceed 4 minutes.
- 11.8.1.1 There shall be one drinks interval during each session of play, scheduled at the mid-point of the session.
- 11.8.1.2 Under conditions of extreme heat the umpires may permit extra intervals for drinks during each session.
- 11.8.1.3 An individual player may be given a drink either on the boundary edge or at the fall of a wicket, on the field, provided that no playing time is wasted. No other drinks shall be taken onto the field without the permission of the umpires. Any player taking drinks onto the field shall be dressed in proper cricket attire (subject to the wearing of bibs – refer to the note in clause 24.1.4).

- 11.8.2 A drinks interval shall be taken at the end of the over in progress when the agreed time is reached. If, however, a wicket falls or a batsman retires within 5 minutes of the agreed time then drinks shall be taken immediately.

No other variation in the timing of drinks intervals shall be permitted except as provided for in clause 11.8.3.

- 11.8.3 If an innings ends or the players have to leave the field of play for any other reason within 30 minutes of the agreed time for a drinks interval, the umpires and captains together may rearrange the timing of drinks intervals in that session.
- 11.8.4 Intervals for drinks may not be taken during the last hour of the match, as defined in clause 12.6 (Last hour of match – number of overs). Subject to this limitation, the captains and umpires shall agree the times for such intervals, if any, before the toss and on each subsequent day not later than 10 minutes before play is scheduled to start.

11.9 Agreement to forgo intervals

At any time during the match, the captains may agree to forgo any of the drinks intervals. The umpires shall be informed of the decision.

When play is in progress, the batsmen at the wicket may deputise for their captain in making an agreement to forgo a drinks interval in that session.

11.10 Scorers to be informed

The umpires shall ensure that the scorers are informed of all agreements about hours of play and intervals and of any changes made thereto as permitted under this clause.

12 START OF PLAY; CESSATION OF PLAY

12.1 Call of Play

The bowler's end umpire shall call Play before the first ball of the match and on the resumption of play after any interval or interruption.

12.2 Call of Time

The bowler's end umpire shall call Time, when the ball is dead, at the end of any session of play or as required by these Playing Conditions. See also clause 20.3 (Call of Over or Time).

12.3 Removal of bails

After the call of Time, the bails shall be removed from both wickets.

12.4 Starting a new over

Another over shall always be started at any time during the match, unless an interval is to be taken in the circumstances set out in clause 12.5.2, if the umpire, walking at normal pace, has arrived at the position behind the stumps at the bowler's end before the time agreed for the next interval, or for the close of play, has been reached.

12.5 Completion of an over

Other than at the end of the match,

12.5.1 if the agreed time for an interval is reached during an over, the over shall be completed before the interval is taken, except as provided for in clause 12.5.2.

12.5.2 when less than 3 minutes remains before the time agreed for the next interval, the interval shall be taken immediately if:

- either a batsman is dismissed or retires; or
- the players have occasion to leave the field,

whether this occurs during an over or at the end of an over. Except at the end of an innings, if an over is thus interrupted it shall be completed on the resumption of play.

12.6 Conclusion of match

12.6.1 The match is concluded

12.6.1.1 as soon as a result as defined in clauses 16.1 to 16.5 (The result) is reached.

12.6.1.2 as soon as both

- the minimum number of overs for the last hour are completed
- and the agreed time for close of play is reached,
- unless a result is reached earlier.

12.6.2 The match is concluded if, without a conclusion having been reached under 12.6.1, the players leave the field for adverse conditions of ground, weather or light, or in exceptional circumstances, and no further play is possible.

12.7 Hours of Play; Minimum Overs Requirement

The Home Board shall determine the hours of play, subject to there being 6 hours scheduled play per day, and subject to:

12.7.1 Minimum Overs in the Day

Subject to clause 12.7.2 below:

12.7.1.1 On days other than the last day, play shall continue on each day until the completion of a minimum target of 90 overs (or a minimum of 15 overs per hour) or the completion of the scheduled or rescheduled cessation time, whichever is the later but provided that play shall not continue for more than 30 minutes beyond the scheduled or rescheduled cessation time (permitted overtime). For the sake of clarity, if any of the minimum target number of overs have not been bowled at the completion of the permitted overtime, play shall cease upon completion of the over in progress. The overs not bowled shall not be made up on any subsequent day.

12.7.1.2 On the last day, a minimum of 75 overs (or a minimum of 15 overs per hour) shall be bowled during the playing time other than the last hour of the match where clause 12.7.6 below shall apply. If any of the minimum of 75 overs, or as recalculated, have not been bowled when one hour of the scheduled playing time remains, the last hour of the match for the purposes of clause 12.7.6 shall be the hour immediately following the completion of these overs.

12.7.2 Reduction in minimum overs

Except in the last hour of the match, for which clause 12.7.6 makes provision, if play is suspended due to adverse weather or light or any other reason (other than normal intervals) for more than 1 hour on any day, the minimum number of overs shall be reduced by 1 over for each full 4 minutes of the aggregate playing time lost. For the avoidance of doubt, the aggregate of 1 hour shall be inclusive of any time that may have been brought forward from previous days due to playing time lost on such previous days under clause 12.7.3.2 below.

12.7.3 Making Up Lost Time

12.7.3.1 On The Day

Subject to weather and light, except in the last hour of the match, in the event of play being suspended for any reason other than normal intervals, the playing time on that day shall be extended by the amount of time lost up to a maximum of 1 hour. For the avoidance of doubt, the maximum of 1 hour shall be inclusive of any time that may have been added to the scheduled playing time due to playing time having been lost on previous days under clause 12.7.3.2 below.

12.7.3.2 On Subsequent Days

If any time is lost and cannot be made up under clause 12.7.3.1 above, additional time of up to a maximum of 30 minutes per day shall be added to the scheduled playing hours for the next day, and subsequent day(s) as required (to make up as much lost time as possible). Where appropriate this additional time shall be added prior to the scheduled start of the first session. In circumstances where it is not possible to add this additional time prior to the scheduled start of the first session, the additional time may be added to the second and/or the third sessions (see also clause 12.7.4). When such additional time is added, the minimum overs for that day shall be increased by one over for each four minutes of additional time or part thereof.

- 12.7.3.3 On the Last Day only (refer to Appendix E)
- Clause 12.7.3.1 applies. However, for the purposes of this clause, the definition of playing time shall exclude the last hour. No time is made up in respect of any interruptions that commence after the start of the last hour.
- Should play be interrupted prior to the last hour being signalled, the playing time lost will be made up (subject to the maximum of 1 hour described in (a) above) with the previously scheduled time for the last hour being updated to reflect the time made up during this interruption.
- In order to determine the minimum overs to be bowled prior to the last hour and the rescheduled starting time for the last hour, it is necessary to complete the template in Appendix E.
- 12.7.3.4 For Day/Night Test matches, the participating teams may agree on the following:
- The maximum amount of make-up time to be used on the day up to no more than 1 hour;
 - The maximum make-up time to be added to subsequent days up to no more than 30 minutes per day; and
 - When the make-up time is to be allocated across subsequent days.
- 12.7.4 Change of Intervals
- 12.7.4.1 If play has been suspended for any reason other than normal intervals for 30 minutes or more prior to the commencement of the scheduled or rescheduled tea interval on that day, the tea interval shall be delayed for 30 minutes.
- 12.7.4.2 Notwithstanding the provisions of clause 12.7.4.1 above, the timings of intervals can be altered under clause 11.4 at any time on any day if playing time has been lost irrespective of whether the time has been lost on that day or on any previous days.
- 12.7.5 Change of Innings
- Where there is a change of innings during a day's play (except where the change of innings occurs at lunch or tea or when play is suspended for any reason) 2 overs will be deducted from the minimum number of overs to be bowled.
- The over in progress at the end of an innings is regarded as a completed over for the purposes of determining the minimum number of remaining overs to be bowled in the day, except when the change of innings occurs in the last hour of the match (see clause 12.12.3).

- 12.7.6 Last Hour
- A minimum of 15 overs shall be bowled in the last hour and all calculations with regard to suspensions of play or the start of a new innings shall be based on 1 over for each full 4 minutes (refer to clause 12.7.9 below).
- On the final day, if both captains (the batsmen at the wicket may act for their captain) accept that there is no prospect of either side achieving a victory, they may agree to finish the match after (a) the time for the commencement of the last hour has been reached OR (b) there are a minimum of 15 overs to be bowled, whichever is the later.
- 12.7.7 Notwithstanding any other provision, there shall be no further play on any day, other than the last day, if a wicket falls or a batsman retires or if the players have occasion to leave the field during the last minimum over within 3 minutes of the scheduled cessation time or thereafter. This shall also apply to the additional time permitted in order to complete the minimum over requirement for the day. If an over is interrupted in these circumstances stumps shall be drawn for the day and the over shall be completed on the resumption of play.
- 12.7.8 An over completed on resumption of a new day's play shall be disregarded in calculating minimum overs for that day.
- 12.7.9 Stumps Drawn
- Except on the final day:
- 12.7.9.1 In the event of play being suspended for any reason at or after the most recently scheduled or rescheduled cessation time, stumps shall be drawn upon play being suspended.
- 12.7.9.2 In the event of the players already being off the field for a suspension of play at the most recently rescheduled cessation time, then stumps will be drawn at that time.
- 12.7.10 The scoreboard shall show:
- 12.7.10.1 the total number of overs bowled with the ball currently in use: and
- 12.7.10.2 the minimum number of overs remaining to be bowled in a day.
- 12.7.11 Penalties shall apply for slow over rates (refer to the ICC Code of Conduct and see clause 12.9 below).
- 12.7.12 Day-Night Tests
- Home Boards may, prior to the commencement of a Test, and with the agreement of the Visiting Board, seek the approval of the ICC to play the match as a day/night Test. In such a case the hours of play shall be determined by agreement between the Home Board and the Visiting Board subject to there being 6 hours scheduled play per day.

12.8 Extra Time**12.8.1 At the End of the Day**

The umpires may decide to play 30 minutes (a minimum of 8 overs) extra time at the end of any day (other than the last day) if requested by either captain if, in the umpires opinion, it would bring about a definite result on that day. This is in addition to the additional time provided for in clause 12.7.3 above. If the umpires do not believe a result can be achieved no extra time shall be allowed.

If it is decided to play such extra time on one or more of these days, the whole period shall be played out even though the possibility of finishing the match may have disappeared before the full period has expired.

If at the conclusion of this extra time, a small number of runs are required to win the match and both captains wish to continue playing in order to achieve a definite result on that day, play will continue until either the match concludes or the players have cause to leave the field for any other reason.

Only the actual amount of playing time by which play is extended on any day shall be deducted from the total number of hours of play remaining, and the match shall end earlier on the final day by the amount of time by which play was previously extended under this clause.

12.8.2 At the Lunch or Tea Interval

The umpires may decide to extend play by 15 minutes (a minimum of four overs) at the scheduled lunch or tea interval of any day if requested by either captain if, in the umpires' opinion, it would bring about a definite result in that session. If the umpires do not believe a result can be achieved no extra time shall be allowed.

If it is decided to extend play, the whole period shall be played out even though the possibility of finishing the match may have disappeared before the full period has expired.

If at the conclusion of this extra time, a small number of runs are required to win the match and both captains wish to continue playing in order to achieve a definite result prior to the scheduled interval, play will continue until either the match concludes or the players have cause to leave the field for any other reason.

The following session of play shall be reduced by the amount of time by which play was previously extended under this clause.

12.8.3 For the avoidance of doubt, clause 11.7 shall still apply subsequent to the application of this clause, i.e when 9 wickets are down following the extra 15 minutes. However, this clause shall not apply when clause 11.7 has already been applied, i.e. the 15 minutes shall not be added at the end of 30 minutes extra time.**12.9 Minimum Over Rates**

12.9.1 The minimum over rate to be achieved in World Test Championship Matches shall be 15 overs per hour.

12.9.2 The actual over rate shall be calculated at the end of the match by the umpires and shall be the average rate which is achieved by the fielding team across both of the batting team's innings.

12.9.3 In calculating the actual over rate for the match, allowances will be given as follows:

12.9.3.1 The time lost as a result of treatment given to a player by an authorised medical personnel on the field of play;

12.9.3.2 The time lost as a result of a player being required to leave the field as a result of a serious injury;

12.9.3.3 The time taken for all third umpire referrals and consultations and any umpire or player reviews;

12.9.3.4 The time lost as a result of time wasting by the batting side; and

12.9.3.5 The time lost due to all other circumstances that are beyond the control of the fielding side.

12.9.3.6 2 minutes per wicket taken, provided that such wicket results in the subsequent batsmen immediately commencing his innings. For the avoidance of any doubt, no time allowance will be given for the final wicket of an innings or where a wicket falls immediately prior to any interval;

12.9.3.7 4 minutes per drinks break taken.

12.9.4 The following conditions shall also be factored into the over rate calculation at the end of the match:

12.9.4.1 if the fielding team bowls out the batting team in 60 overs or less in any particular innings and the Minimum Over Rate requirement for that innings has not been exceeded (taking into account all of the time allowances described above), no account shall be taken of the actual over rate in that innings when calculating the actual over rate at the end of such Match.

12.9.4.2 if the fielding team bowls out the batting team twice and has not completed more than 120 overs in total across both of its fielding innings, no sanction may be imposed in respect of a breach of clause 12.9.1.

12.9.4.3 if the fielding team has not completed more than 60 overs in a Match, no sanction may be imposed in respect of a breach of clause 12.9.1.

12.9.5 The current over rate of the fielding team (+/- overs compared to the minimum rate required), shall be advised by the third umpire every 30 minutes as a minimum, and shall be displayed on a scoreboard or replay screen at regular intervals.

- 12.9.6 If, at the end of the match, the over rate calculation determines that a team has bowled one or more overs less than the minimum over rate requirement, that team will incur one Penalty Over for each full over the team falls short of its minimum over rate required in a match.
- 12.9.7 A team will have two (2) World Test Championship competition points deducted from its points total for each Penalty Over it incurs during the Round Stage.

12.10 Last hour of match – number of overs

The bowler's end umpire shall indicate the commencement of this 15 overs to the players and to the scorers. The period of play thereafter shall be referred to as the last hour, whatever its actual duration.

During an uninterrupted last hour, play will continue until the end of the over in progress when 60 minutes have been played, or until 15 overs have been bowled, whichever is later.

12.11 Last hour of match – interruptions of play

If there is an interruption in play during the last hour of the match, the minimum number of overs to be bowled shall be reduced from 15 as follows:

- 12.11.1 The time lost for an interruption is counted from the call of Time until the time for resumption as decided by the umpires.
- 12.11.2 One over shall be deducted for every complete 4 minutes of time lost.
- 12.11.3 In the case of more than one such interruption, the minutes lost shall not be aggregated; the calculation shall be made for each interruption separately.
- 12.11.4 If, when one hour of Playing time remains, an interruption is already in progress
- 12.11.4.1 only the time lost after this moment shall be counted in the calculation.
- 12.11.4.2 the over in progress at the start of the interruption shall be completed on resumption and shall not count as one of the minimum number of overs to be bowled.
- 12.11.5 If, after the start of the last hour, an interruption occurs during an over, the over shall be completed on resumption of play. The two part-overs shall between them count as one over of the minimum number to be bowled.

12.12 Last hour of match – intervals between innings

If an innings ends so that a new innings is to be started during the last hour of the match, the interval starts with the end of the innings and is to end 10 minutes later.

- 12.12.1 If this interval is already in progress at the start of the last hour then, to determine the number of overs to be bowled in the new innings, calculations are to be made as set out in clause 12.11.

- 12.12.2 If the innings ends after the last hour has started, two calculations are to be made, as set out in clauses 12.12.3 and 12.12.4. The greater of the numbers yielded by these two calculations is to be the minimum number of overs to be bowled in the new innings.
- 12.12.3 Calculation based on overs remaining:
- At the conclusion of the innings, the number of overs that remain to be bowled, of the minimum in the last hour, to be noted.
 - If this is not a whole number it is to be rounded up to the next whole number.
 - Two overs, for the interval, to be deducted from the resulting number to determine the number of overs still to be bowled.
- 12.12.4 Calculation based on time remaining:
- At the conclusion of the innings, the time remaining until the agreed time for close of play to be noted.
 - 10 minutes, for the interval, to be deducted from this time to determine the Playing time remaining.
 - A calculation to be made of one over for every complete 4 minutes of the Playing time remaining, plus one more over if a further part of 4 minutes remains.

12.13 Completion of last over of match

The over in progress at the close of play on the final day shall be completed unless

either a result has been reached; or

the players have occasion to leave the field. In this case there shall be no resumption of play except in the circumstances of clause 16.7 (Mistakes in scoring) and the match shall be at an end.

12.14 Bowler unable to complete an over during last hour of match

If, for any reason, a bowler is unable to complete an over during the last hour, clause 17.8 (Bowler incapacitated or suspended during an over) shall apply. The separate parts of such an over shall count as one over of the minimum to be bowled.

13 INNINGS

13.1 Number of innings

- 13.1.1 A match shall be two innings for each side.

13.2 Alternate innings

Each side shall take their innings alternately except in the cases provided for in clause 14 (The follow-on) or in clause 15.2 (Forfeiture of an innings).

13.3 Completed innings

A side's innings is to be considered as completed if any of the following applies

- 13.3.1 the side is all out.
- 13.3.2 at the fall of a wicket or the retirement of a batsman, further balls remain to be bowled but no further batsman is available to come in.
- 13.3.3 the captain declares the innings closed.
- 13.3.4 the captain forfeits the innings.

13.4 The toss

The captains shall toss a coin for the choice of innings, on the field of play and under the supervision of the ICC Match Referee, not earlier than 30 minutes, nor later than 15 minutes before the scheduled or any rescheduled time for the start of play. Note, however, the provisions of clause 1.3 (Captain).

13.5 Decision to be notified

As soon as the toss is completed, the captain of the side winning the toss shall decide whether to bat or to field and shall notify the opposing captain and the umpires of this decision. Once notified, the decision cannot be changed.

13.6 Duration of Match

Matches shall be of five days scheduled duration.

14 THE FOLLOW-ON**14.1 Lead on first innings**

- 14.1.1 The side which bats first and leads by at least 200 runs shall have the option of requiring the other side to follow their innings.
- 14.1.2 The same option shall be available in matches of shorter duration with the minimum leads as follows:
 - 150 runs in a match of 3 or 4 days;
 - 100 runs in a 2-day match;
 - 75 runs in a 1-day match.

14.2 Notification

A captain shall notify the opposing captain and the umpires of his intention to take up this option. Once notified, the decision cannot be changed.

14.3 First day's play lost

If no play takes place on the first day of a match, 14.1 shall apply in accordance with the number of days remaining from the start of play. The day on which play first commences shall count as a whole day for this purpose, irrespective of the time at which play starts.

Play will have taken place as soon as, after the call of Play, the first over has started. See clause 17.2 (Start of an over).

15 DECLARATION AND FORFEITURE**15.1 Time of declaration**

The captain of the side batting may declare an innings closed, when the ball is dead, at any time during the innings. A declared innings shall be considered to be a completed innings.

15.2 Forfeiture of an innings

A captain may forfeit either of his side's innings at any time before the commencement of that innings. A forfeited innings shall be considered to be a completed innings.

15.3 Notification

A captain shall notify the opposing captain and the umpires of any decision to declare or to forfeit an innings. Once notified, the decision cannot be changed.

16 THE RESULT**16.1 A Win**

The side which has scored a total of runs in excess of that scored in the two completed innings of the opposing side shall win the match. See clause 13.3 (Completed innings). Note also clause 16.4 (Winning hit or extras).

16.2 ICC Match Referee awarding a match

- 16.2.1 A match shall be lost by a side which either
 - 16.2.1.1 concedes defeat or
 - 16.2.1.2 in the opinion of the ICC Match Referee refuses to play and the ICC Match Referee shall award the match to the other side.
- 16.2.2 If an umpire considers that an action by any player or players might constitute a refusal by either side to play then the umpires together shall inform the ICC Match Referee of this fact. The ICC Match Referee shall together with the umpires ascertain the cause of the action. If the ICC Match Referee, after due consultation with the umpires, then decides that this action does constitute a refusal to play by one side, he/she shall so inform the captain of that side. If the captain persists in the action the ICC Match Referee shall award the match in accordance with clause 16.2.1.2 above.
- 16.2.3 If action as in clause 16.2.2 above takes place after play has started and does not constitute a refusal to play:
 - 16.2.3.1 Playing time lost shall be counted from the start of the action until play recommences, subject to intervals (clause 11) and suspensions of play (clause 2.8).
 - 16.2.3.2 the time for close of play on that day shall be extended by this length of time, subject to clause 2.8 (Suspension of play in dangerous and unreasonable conditions) and the provisions of clause 12.7.

- 16.2.3.3 if applicable, no overs shall be deducted during the last hour of the match solely on account of this time.

In addition to the consequences of any refusal to play prescribed under this clause, any such refusal, whether temporary or final, may result in disciplinary action being taken against the captain and team responsible under the ICC Code of Conduct.

16.3 All other matches – A Tie or Draw

16.3.1 A Tie

The result of a match shall be a Tie when all innings have been completed and the scores are equal.

16.3.2 A Draw

The result of a match shall be a Draw when it is not determined in any of the ways stated in clauses 16.1, 16.2 or 16.3.1.

16.4 Winning hit or extras

- 16.4.1 As soon as a result is reached as defined in clauses 16.1, 16.2 or 16.3.1, the match is at an end. Nothing that happens thereafter, except as in clause 41.18.2 (Penalty runs), shall be regarded as part of it. Note also clause 16.7.

- 16.4.2 The side batting last will have scored enough runs to win only if its total of runs is sufficient without including any runs completed by the batsmen before the completion of a catch, or the obstruction of a catch, from which the striker could be dismissed.

- 16.4.3 If a boundary is scored before the batsmen have completed sufficient runs to win the match, the whole of the boundary allowance shall be credited to the side's total and, in the case of a hit by the bat, to the striker's score.

16.5 Statement of result

If the side batting last wins the match without losing all its wickets, the result shall be stated as a win by the number of wickets still then to fall.

If, without having scored a total of runs in excess of the total scored by the opposing side, the innings of the side batting last has been completed, but as the result of an award of 5 Penalty runs its total of runs is then sufficient to win, the result shall be stated as a win to that side by Penalty runs.

If the side fielding last wins the match, the result shall be stated as a win by runs.

If the match is decided by one side conceding defeat or refusing to play, the result shall be stated as Match Conceded or Match Awarded, as the case may be.

16.6 Correctness of result

Any decision as to the correctness of the scores shall be the responsibility of the umpires. See clause 2.15 (Correctness of scores).

16.7 Mistakes in scoring

If, after the players and umpires have left the field in the belief that the match has been concluded, the umpires discover that a mistake in scoring has occurred which affects the result then, subject to clause 16.8, they shall adopt the following procedure.

- 16.7.1 If, when the players leave the field, the side batting last has not completed its innings and:

either the number of overs to be bowled in the last hour, or in that innings, has not been completed; or

the agreed time for close of play, or for the end of the innings, has not been reached,

then, unless one side concedes defeat, the umpires shall order play to resume.

Unless a result is reached sooner, play will then continue, if conditions permit, until the prescribed number of overs has been completed and either time for close of play has been reached or the allotted time for the innings has expired, as appropriate. The number of overs and time remaining shall be taken as they were at the call of Time for the supposed conclusion of the match. No account shall be taken of the time between that moment and the resumption of play.

- 16.7.2 If, at this call of Time, the overs have been completed and no Playing time remains, or if the side batting last has completed its innings, the umpires shall immediately inform both captains of the necessary corrections to the scores and to the result.

16.8 Result not to be changed

Once the umpires have agreed with the scorers the correctness of the scores at the conclusion of the match – see clauses 2.15 (Correctness of scores) and 3.2 (Correctness of scores) – the result cannot thereafter be changed.

16.9 Competition Format

- 16.9.1 The ICC World Test Championship will be contested by 9 teams. Australia, Bangladesh, England, India, New Zealand, Pakistan, South Africa, Sri Lanka, West Indies.
- 16.9.2 The competition will be contested in two stages; the Round Stage and the Final.
- 16.9.3 Each team will play six (6) series as part of the Round Stage, three (3) series at home and three (3) series away.
- 16.9.4 Each series shall consist of a minimum of two (2) Tests, and a maximum of five (5) Tests.
- 16.9.5 The two highest-placed teams at the end of the Round Stage will contest the Final.

16.10 Points

- 16.10.1 The maximum number of points available for each series in the Round Stage of the ICC World Test Championship shall be one hundred and twenty (120), regardless of how many matches the series comprises.
- 16.10.2 Points shall be distributed evenly across the number of matches in the series, according to the following table:

LENGTH OF SERIES	MATCH RESULT				MAXIMUM POINTS AVAILABLE PER SERIES
	POINTS FOR A WIN	POINTS FOR A TIE	POINTS FOR A DRAW	POINT FOR A LOSS	
2 matches	60	30	20	0	120
3 matches	40	20	13	0	120
4 matches	30	15	10	0	120
5 matches	24	12	8	0	120

- 16.10.3 If a match is abandoned and the pitch and/or outfield is ultimately rated as 'Unfit' under the ICC Pitch and Outfield Monitoring Process, points for that match shall be distributed on the basis that the visiting team won the match and the home team lost the match. Any abandoned match will be classified as a drawn match for statistical purposes.

16.11 Penalty Overs – Points Deduction

- 16.11.1 Any team which has been unable to maintain the minimum over rate as defined in 12.9 will incur one Penalty Over for each full over it is short of the minimum over rate requirement.
- 16.11.2 A team will have two (2) World Test Championship competition points deducted from its points total for each Penalty Over it incurs during the Round Stage.

16.12 Points Table

- 16.12.1 The World Test Championship Points Table will rank the teams in order of the Total Points earned across the six series. Total Points earned will be the points won or awarded (16.10 above) less the points deducted through any Penalty Overs incurred (16.11 above).
- 16.12.2 Where two or more teams are level on points at the end of the Round Stage, the following criteria shall be used to determine positions in the World Test Championship table:
- 16.12.2.1 The team that has won the greater number of series during the Round Stage will be placed higher;
- 16.12.2.2 If still equal, the team with the higher Runs per Wicket Ratio (runs scored per wicket lost, divided by runs conceded per wicket taken) throughout the Round Stage will be placed higher;

- 16.12.2.1 In calculating the Runs per Wicket Ratio, a team forfeiting or declaring its innings closed shall be deemed to have lost only the number of wickets that have actually fallen.

- 16.12.2.2 If a match is awarded to the visiting team under 16.10.3 above, the runs scored / conceded and the wickets lost / taken in that match shall not be included in the calculation of the Runs per Wicket Ratio for the two teams involved in that match.

- 16.12.2.3 If still equal, the team that is ranked in the higher position in the ICC Men's Test Team Rankings as at the final day of the Competition Window shall be placed higher.

16.13 Qualifying for the Final

- 16.13.1 The two highest-placed teams at the end of the Round Stage will contest the World Test Championship Final.
- 16.13.2 The ICC World Test Championship Final will be hosted by the England and Wales Cricket Board, and be scheduled over five (5) days, from 10-14 June 2021. A Reserve Day will be also scheduled for the Final, to be used if net playing time is lost across the scheduled days of the match.
- 16.13.3 The full playing conditions for the ICC World Test Championship Final will be prepared and be distributed in early 2021.

17 THE OVER**17.1 Number of balls**

The ball shall be bowled from each end alternately in overs of 6 balls.

17.2 Start of an over

An over has started when the bowler starts his run-up or, if there is no run-up, starts his action for the first delivery of that over.

17.3 Validity of balls

- 17.3.1 A ball shall not count as one of the 6 balls of the over unless it is delivered, even though, as in clause 41.16 (Non-striker leaving his ground early) a batsman may be dismissed or some other incident occurs without the ball having been delivered.
- 17.3.2 A ball delivered by the bowler shall not count as one of the 6 balls of the over
- 17.3.2.1 if it is called dead, or is to be considered dead, before the striker has had an opportunity to play it. See clause 20.6 (Dead ball; ball counting as one of over).
- 17.3.2.2 if it is called dead in the circumstances of clause 20.4.2.6. Note also the special provisions of clause 20.4.2.5 (Umpire calling and signaling Dead ball).

- 17.3.2.3 if it is a No ball. See clause 21 (No ball).
 - 17.3.2.4 if it is a Wide. See clause 22 (Wide ball).
 - 17.3.2.5 when any of clauses 24.4 (Player returning without permission), 28.2 (Fielding the ball), 41.4 (Deliberate attempt to distract striker), or 41.5 (Deliberate distraction, deception or obstruction of batsman) is applied.
- 17.3.3 Any deliveries other than those listed in clauses 17.3.1 and 17.3.2 shall be known as valid balls. Only valid balls shall count towards the 6 balls of the over.

17.4 Call of Over

When 6 valid balls have been bowled and when the ball becomes dead, the umpire shall call Over before leaving the wicket. See also clause 20.3 (Call of Over or Time).

17.5 Umpire miscounting

- 17.5.1 If the umpire miscounts the number of valid balls, the over as counted by the umpire shall stand.
- 17.5.2 If, having miscounted, the umpire allows an over to continue after 6 valid balls have been bowled, he/she may subsequently call Over when the ball becomes dead after any delivery, even if that delivery is not a valid ball.
- 17.5.3 Whenever possible, the third umpire shall liaise with the scorers and if possible inform the on-field umpires if the over has been miscounted.

17.6 Bowler changing ends

A bowler shall be allowed to change ends as often as desired, provided he does not bowl two overs consecutively, nor bowl parts of each of two consecutive overs, in the same innings.

17.7 Finishing an over

- 17.7.1 Other than at the end of an innings, a bowler shall finish an over in progress unless incapacitated or suspended under these Playing Conditions.
- 17.7.2 If for any reason, other than the end of an innings, an over is left uncompleted at the start of an interval or interruption, it shall be completed on resumption of play.

17.8 Bowler incapacitated or suspended during an over

If for any reason a bowler is incapacitated while running up to deliver the first ball of an over, or is incapacitated or suspended during an over, the umpire shall call and signal Dead ball. Another bowler shall complete the over from the same end, provided that he does not bowl two overs consecutively, nor bowl parts of each of two consecutive overs, in that innings.

18 SCORING RUNS

18.1 A run

The score shall be reckoned by runs. A run is scored

- 18.1.1 so often as the batsmen, at any time while the ball is in play, have crossed and made good their ground from end to end.
- 18.1.2 when a boundary is scored. See clause 19 (Boundaries).
- 18.1.3 when Penalty runs are awarded. See clause 18.6.

18.2 Runs disallowed

Wherever in these Playing Conditions provision is made for the scoring of runs or awarding of penalties, such runs and penalties will be subject to any provisions that may be applicable for the disallowance of runs or for the non-award of penalties.

When runs are disallowed, the one run penalty for No ball or Wide shall stand and 5 run penalties shall be allowed, except for Penalty runs under clause 28.3 (Protective helmets belonging to the fielding side).

18.3 Short runs

- 18.3.1 A run is short if a batsman fails to make good his ground in turning for a further run.
- 18.3.2 Although a short run shortens the succeeding one, the latter if completed shall not be regarded as short. A striker setting off for the first run from in front of the popping crease may do so also without penalty.

18.4 Unintentional short runs

Except in the circumstances of clause 18.5,

- 18.4.1 if either batsman runs a short run, the umpire concerned shall, unless a boundary is scored, call and signal Short run as soon as the ball becomes dead and that run shall not be scored.
- 18.4.2 if, after either or both batsmen run short, a boundary is scored the umpire concerned shall disregard the short running and shall not call or signal Short run.
- 18.4.3 if both batsmen run short in one and the same run, this shall be regarded as only one short run.
- 18.4.4 if more than one run is short then, subject to clauses 18.4.2 and 18.4.3, all runs called as short shall not be scored.
- 18.4.5 if there has been more than one short run, the umpire shall inform the scorers as to the number of runs to be recorded.

18.5 Deliberate short runs

- 18.5.1 If either umpire considers that one or both batsmen deliberately ran short at that umpire's end, the umpire concerned shall, when the ball is dead, call and signal Short run and inform the other umpire of what has occurred and apply clause 18.5.2.

- 18.5.2 The bowler's end umpire shall
- disallow all runs to the batting side;
 - return any not out batsman to his original end;
 - signal No ball or Wide to the scorers, if applicable;
 - award 5 Penalty runs to the fielding side;
 - award any other 5-run Penalty that is applicable except for Penalty runs under clause 28.3 (Protective helmets belonging to the fielding side);
 - inform the scorers as to the number of runs to be recorded; and
 - inform the captain of the fielding side and, as soon as practicable, the captain of the batting side of the reason for this action.

18.6 Runs awarded for penalties

Runs shall be awarded for penalties under clauses 18.5 (Deliberate short runs), 21 (No ball), 22 (Wide ball), 24.4 (Player returning without permission), 26.4 (Penalties for contravention), 28.2 (Fielding the ball), 28.3 (Protective helmets belonging to the fielding side), 41 (Unfair play) and 42 (Players' conduct). Note, however, the restrictions on the award of Penalty runs in clauses 23.3 (Leg byes not to be awarded), 28.3 (Protective helmets belonging to the fielding side) and 34 (Hit the ball twice)

18.7 Runs scored for boundaries

Runs shall be scored for boundary allowances under clause 19 (Boundaries).

18.8 Runs scored when a batsman is dismissed

When a batsman is dismissed, any runs for penalties awarded to either side shall stand.

No other runs shall be credited to the batting side, except as follows.

- 18.8.1 If a batsman is dismissed Obstructing the field, the batting side shall also score any runs completed before the offence.

If, however, the obstruction prevented a catch being made, no runs other than penalties shall be scored.

- 18.8.2 If a batsman is dismissed Run out, the batting side shall also score any runs completed before the wicket was put down:

18.9 Runs scored when the ball becomes dead other than at the fall of a wicket

When the ball becomes dead for any reason other than the fall of a wicket, or is called dead by an umpire, unless there is specific provision otherwise in these Playing Conditions, any runs for penalties awarded to either side shall be scored. Note however the provisions of clauses 23.3 (Leg byes not to be awarded) and 28.3 (Protective helmets belonging to the fielding side).

Additionally the batting side shall be credited with all runs completed by the batsmen before the incident or call of Dead ball and the run in progress if the batsmen had already crossed at the instant of the incident or call of Dead ball. Note specifically, however, the provisions of clause 41.5.8 (Deliberate distraction, deception or obstruction of batsman).

18.10 Crediting of runs scored

Unless stated otherwise in these Playing Conditions,

- 18.10.1 if the ball is struck by the bat, all runs scored by the batting side shall be credited to the striker, except for the following:

- an award of 5 Penalty runs, which shall be scored as Penalty runs
- the one run penalty for a No ball, which shall be scored as a No ball extra.

- 18.10.2 if the ball is not struck by the bat, runs shall be scored as Penalty runs, Byes, Leg byes, No ball extras or Wides as the case may be. If Byes or Leg byes accrue from a No ball, only the one run penalty for No ball shall be scored as such, and the remainder as Byes or Leg byes as appropriate.

- 18.10.3 the bowler shall be debited with:

- all runs scored by the striker
- all runs scored as No ball extras
- all runs scored as Wides.

18.11 Batsman returning to original end

- 18.11.1 When the striker is dismissed in any of the circumstances in clauses 18.11.1.1 to 18.11.1.5, the not out batsman shall return to his original end.

18.11.1.1 Bowled.

18.11.1.2 Stumped.

18.11.1.3 Hit the ball twice.

18.11.1.4 LBW.

18.11.1.5 Hit wicket.

- 18.11.2 The batsmen shall return to their original ends in any of the cases of clauses 18.11.2.1 to 18.11.2.3.

18.11.2.1 A boundary is scored.

18.11.2.2 Runs are disallowed for any reason.

18.11.2.3 A decision by the batsmen at the wicket to do so, under clause 41.5 (Deliberate distraction, deception or obstruction of batsman).

18.12 Batsman returning to wicket he has left

- 18.12.1 When a batsman is dismissed in any of the ways in clauses 18.12.1.1 to 18.12.1.3, the not out batsman shall return to the wicket he has left but only if the batsmen had not already crossed at the instant of the incident causing the dismissal. If runs are to be disallowed, however, the not out batsman shall return to his original end.
- 18.12.1.1 Caught
- 18.12.1.2 Obstructing the field
- 18.12.1.3 Run out.
- 18.12.2 If, while a run is in progress, the ball becomes dead for any reason other than the dismissal of a batsman, the batsmen shall return to the wickets they had left, but only if they had not already crossed in running when the ball became dead. If, however, any of the circumstances of clauses 18.11.2.1 to 18.11.2.3 apply, the batsmen shall return to their original ends.

19 BOUNDARIES**19.1 Determining the boundary of the field of play**

- 19.1.1 Before the toss, the umpires shall determine the boundary of the field of play, which shall be fixed for the duration of the match. See clause 2.3.4 (Consultation with Home Board).
- 19.1.2 The boundary shall be determined such that no part of any sight-screen, will, at any stage of the match, be within the field of play.
- 19.1.3 The aim shall be to maximize the size of the playing area at each venue. With respect to the size of the boundaries, no boundary shall be longer than 90 yards (82.29 meters), and no boundary should be shorter than 65 yards (59.43 metres) from the centre of the pitch to be used.
- 19.1.4 At all times, there must be 3 yards (2.74 meters) from the boundary rope to the first solid object (advertising boards/LEDs, photographers, cameramen, dug outs, covers, perimeter fence) for the player's safety run off.
- 19.1.5 If the boundary is positioned less than 90 yards (82.29 meters) from the centre of the pitch, the boundary rope cannot be set at a distance of more than 10 yards (9.14 meters) from the perimeter fence. The 10 yards shall be inclusive of the 3 yards (2.74 meters) provided for the player's safety run off.
- 19.1.6 Any ground which has previously been approved to host international cricket which is unable to conform to the minimum boundary dimension shall be exempt. In such cases the boundary shall be positioned so as to maximize the size of the playing area. Any ground which has previously been approved to host international cricket which is unable to conform to the minimum boundary dimension shall be exempt. In such cases the boundary shall be positioned so as to maximize the size of the playing area.

19.2 Identifying and marking the boundary

- 19.2.1 All boundaries must be designated by a rope, or similar object of a minimum standard as authorised by the ICC from time to time.
- 19.2.2 If the boundary is marked by means of an object that is in contact with the ground the boundary will be the edge of the grounded part of the object which is nearest the pitch.
- 19.2.3 An obstacle within the field of play shall not be regarded as a boundary unless so determined by the umpires before the toss. See clause 2.3.4 (Consultation with Home Board).
- 19.2.4 If an unauthorised person enters the playing arena and handles the ball, the umpire at the bowler's end shall be the sole judge of whether the boundary allowance should be scored or the ball be treated as still in play or called dead ball if a batsman is liable to be out as a result of the unauthorised person handling the ball.

19.3 Restoring the boundary

If a solid object used to mark the boundary is disturbed for any reason, then:

- 19.3.1 the boundary shall be considered to be in its original position.
- 19.3.2 the object shall be returned to its original position as soon as is practicable; if play is taking place, this shall be as soon as the ball is dead.
- 19.3.3 if some part of a fence or other marker has come within the field of play, that part shall be removed from the field of play as soon as is practicable; if play is taking place, this shall be as soon as the ball is dead.

19.4 Ball grounded beyond the boundary

- 19.4.1 The ball in play is grounded beyond the boundary if it touches
- the boundary or any part of an object used to mark the boundary;
 - the ground beyond the boundary;
 - any object that is grounded beyond the boundary.
- 19.4.2 The ball in play is to be regarded as being grounded beyond the boundary if
- a fielder, grounded beyond the boundary as in clause 19.5, touches the ball;
 - a fielder, after catching the ball within the boundary, becomes grounded beyond the boundary while in contact with the ball, before completing the catch.

19.5 Fielder grounded beyond the boundary

- 19.5.1 A fielder is grounded beyond the boundary if some part of his person is in contact with any of the following:
- the boundary or any part of an object used to mark the boundary;
 - the ground beyond the boundary;
 - any object that is in contact with the ground beyond the boundary;
 - another fielder who is grounded beyond the boundary.

- 19.5.2 A fielder who is not in contact with the ground is considered to be grounded beyond the boundary if his final contact with the ground, before his first contact with the ball after it has been delivered by the bowler, was not entirely within the boundary.

19.6 Boundary allowances

- 19.6.1 6 runs shall be allowed for a boundary 6; and 4 runs for a boundary 4. See also clause 19.7.

19.7 Runs scored from boundaries

- 19.7.1 A boundary 6 will be scored if and only if the ball has been struck by the bat and is first grounded beyond the boundary without having been in contact with the ground within the field of play. This shall apply even if the ball has previously touched a fielder.
- 19.7.2 A boundary 4 will be scored when a ball that is grounded beyond the boundary
- whether struck by the bat or not, was first grounded within the boundary, or
 - has not been struck by the bat.
- 19.7.3 When a boundary is scored, the batting side, except in the circumstances of clause 19.8, shall be awarded whichever is the greater of
- 19.7.3.1 the allowance for the boundary
- 19.7.3.2 the runs completed by the batsmen together with the run in progress if they had already crossed at the instant the boundary is scored.
- 19.7.4 When the runs in clause 19.7.3.2 exceed the boundary allowance they shall replace the boundary allowance for the purposes of clause 18.12.2.
- 19.7.5 The scoring of Penalty runs by either side is not affected by the scoring of a boundary.

19.8 Overthrow or wilful act of fielder

If the boundary results from an overthrow or from the wilful act of a fielder, the runs scored shall be

any runs for penalties awarded to either side

and the allowance for the boundary

and the runs completed by the batsmen, together with the run in progress if they had already crossed at the instant of the throw or act.

Clause 18.12.2 (Batsman returning to wicket he has left) shall apply as from the instant of the throw or act.

20 DEAD BALL

20.1 Ball is dead

- 20.1.1 The ball becomes dead when
- 20.1.1.1 it is finally settled in the hands of the wicket-keeper or of the bowler.
- 20.1.1.2 a boundary is scored. See clause 19.7 (Runs scored from boundaries).
- 20.1.1.3 a batsman is dismissed. The ball will be deemed to be dead from the instant of the incident causing the dismissal.
- 20.1.1.4 whether played or not it becomes trapped between the bat and person of a batsman or between items of his clothing or equipment.
- 20.1.1.5 whether played or not it lodges in the clothing or equipment of a batsman or the clothing of an umpire.
- 20.1.1.6 there is an award of Penalty runs under either of clauses 24.4 (Player returning without permission) or 28.2 (Fielding the ball). The ball shall not count as one of the over.
- 20.1.1.7 there is a contravention of clause 28.3 (Protective helmets belonging to the fielding side).
- 20.1.1.8 the match is concluded in any of the ways stated in clause 12.6 (Conclusion of match).
- 20.1.2 The ball shall be considered to be dead when it is clear to the bowler's end umpire that the fielding side and both batsmen at the wicket have ceased to regard it as in play.
- 20.1.3 In a match where cameras are being used on or over the field of play (e.g. Spidercam), should a ball that has been hit by the batsman make contact, while still in play, with the camera, its apparatus or its cable, either umpire shall call and signal 'dead ball'. The ball shall not count as one of the over and no runs shall be scored. If the delivery was called a No ball it shall count and the No ball penalty shall be applied. No other runs (including penalty runs) apart from the No ball penalty shall be scored.
- 20.1.4 Should a ball thrown by a fielder make contact with a camera on or over the field of play, its apparatus or its cable, either umpire shall call and signal dead ball. Unless this was already a No ball or Wide, the ball shall count as one of the over. All runs scored to that point shall count, plus the run in progress if the batsmen have already crossed.
- 20.1.5 Refer also to paragraph 2.6 of Appendix D.

20.2 Ball finally settled

Whether the ball is finally settled or not is a matter for the umpire alone to decide.

20.3 Call of Over or Time

Neither the call of Over (see clause 17.4), nor the call of Time (see clause 12.2) is to be made until the ball is dead, either under clauses 20.1 or 20.4.

20.4 Umpire calling and signalling Dead ball

- 20.4.1 When the ball has become dead under clause 20.1, the bowler's end umpire may call and signal Dead ball if it is necessary to inform the players.
- 20.4.2 Either umpire shall call and signal Dead ball when
- 20.4.2.1 intervening in a case of unfair play.
 - 20.4.2.2 a possibly serious injury to a player or umpire occurs.
 - 20.4.2.3 leaving his/her normal position for consultation.
 - 20.4.2.4 one or both bails fall from the striker's wicket before the striker has had the opportunity of playing the ball.
 - 20.4.2.5 the striker is not ready for the delivery of the ball and, if the ball is delivered, makes no attempt to play it. Provided the umpire is satisfied that the striker had adequate reason for not being ready, the ball shall not count as one of the over.
 - 20.4.2.6 the striker is distracted by any noise or movement or in any other way while preparing to receive, or receiving a delivery. This shall apply whether the source of the distraction is within the match or outside it. Note also clause 20.4.2.7. The ball shall not count as one of the over.
 - 20.4.2.7 there is an instance of a deliberate attempt to distract under either of clauses 41.4 (Deliberate attempt to distract striker) or 41.5 (Deliberate distraction, deception or obstruction of batsman). The ball shall not count as one of the over.
 - 20.4.2.8 the bowler drops the ball accidentally before delivery.
 - 20.4.2.9 the ball does not leave the bowler's hand for any reason other than an attempt to run out the non-striker under clause 41.16 (Non-striker leaving his ground early).
 - 20.4.2.10 satisfied that the ball in play cannot be recovered.
 - 20.4.2.11 required to do so under any of the Playing Conditions not included above.

20.5 Ball ceases to be dead

The ball ceases to be dead – that is, it comes into play – when the bowler starts his run-up or, if there is no run-up, starts his bowling action.

20.6 Dead ball; ball counting as one of over

- 20.6.1 When a ball which has been delivered is called dead or is to be considered dead then, other than as in clause 20.6.2,
- 20.6.1.1 it will not count in the over if the striker has not had an opportunity to play it.

- 20.6.1.2 unless No ball or Wide ball has been called, it will be a valid ball if the striker has had an opportunity to play it, except in the circumstances of clauses 20.4.2.6 and 24.4 (Player returning without permission), 28.2 (Fielding the ball), 41.4 (Deliberate attempt to distract striker) and 41.5 (Deliberate distraction, deception or obstruction of batsman).
- 20.6.2 In clause 20.4.2.5, the ball will not count in the over only if both conditions of not attempting to play the ball and having an adequate reason for not being ready are met. Otherwise the delivery will be a valid ball.

21 NO BALL**21.1 Mode of delivery**

- 21.1.1 The umpire shall ascertain whether the bowler intends to bowl right handed or left handed, over or round the wicket, and shall so inform the striker.
- It is unfair if the bowler fails to notify the umpire of a change in his mode of delivery. In this case the umpire shall call and signal No ball.
- 21.1.2 Underarm bowling shall not be permitted.

21.2 Fair delivery – the arm

For a delivery to be fair in respect of the arm the ball must not be delivered with an Illegal Bowling Action.

An Illegal Bowling Action is defined as a bowling action where a bowler's Elbow Extension exceeds 15 degrees, measured from the point at which the bowling arm reaches the horizontal until the point at which the ball is released (any Elbow Hyperextension shall be discounted for the purposes of determining an Illegal Bowling Action).

Should either umpire or the ICC Match Referee suspect that a bowler has used an Illegal Bowling Action, they shall complete the ICC Bowling Action Report Form at the conclusion of the match, as set out in the Illegal Bowling Regulations.

21.3 Ball thrown or delivered underarm – action by umpires

- 21.3.1 If, in the opinion of either umpire, the ball has been thrown (where such mode of delivery does not correspond to the bowler's normal bowling action) or delivered underarm, he/she shall call and signal No ball and, when the ball is dead, inform the other umpire of the reason for the call.

The bowler's end umpire shall then

- warn the bowler, indicating that this is a first and final warning. This warning shall apply to that bowler throughout the innings.
- inform the captain of the fielding side of the reason for this action.
- inform the batsmen at the wicket of what has occurred.

- 21.3.2 If either umpire considers that, in that innings, a further delivery by the same bowler is thrown (where such mode of delivery does not correspond to the bowler's normal bowling action) or delivered underarm, he/she shall call and signal No ball and when the ball is dead inform the other umpire of the reason for the call.

The bowler's end umpire shall then

- direct the captain of the fielding side to suspend the bowler immediately from bowling. The over shall, if applicable, be completed by another bowler, who shall neither have bowled the previous over or part thereof nor be allowed to bowl any part of the next over. The bowler thus suspended shall not bowl again in that innings.
- inform the batsmen at the wicket and, as soon as practicable, the captain of the batting side of the reason for this action.

- 21.3.3 The umpires together shall report the occurrence as soon as possible after the match to the ICC Match Referee, who shall take such action as is considered appropriate against the bowler concerned.

21.4 Bowler throwing towards striker's end before delivery

If the bowler throws the ball towards the striker's end before entering the delivery stride, either umpire shall call and signal No ball. See clause 41.17 (Batsmen stealing a run).

However, the procedure stated in clause 21.3 of caution, informing, final warning, action against the bowler and reporting shall not apply.

21.5 Fair delivery – the feet

For a delivery to be fair in respect of the feet, in the delivery stride

- 21.5.1 the bowler's back foot must land within and not touching the return crease appertaining to his stated mode of delivery.
- 21.5.2 the bowler's front foot must land with some part of the foot, whether grounded or raised
- on the same side of the imaginary line joining the two middle stumps as the return crease described in clause 21.5.1, and
 - behind the popping crease.

If the bowler's end umpire is satisfied that any of these three conditions have not been met, he/she shall call and signal No ball. See clause 41.8 (Bowling of deliberate front foot No ball).

21.6 Bowler breaking wicket in delivering ball

Either umpire shall call and signal No ball if, other than in an attempt to run out the non-striker under clause 41.16, the bowler breaks the wicket at any time after the ball comes into play and before completion of the stride after the delivery stride. This shall include any clothing or other object that falls from his person and breaks the wicket.

21.7 Ball bouncing more than once, rolling along the ground or pitching off the pitch

The umpire shall call and signal No ball if a ball which he/she considers to have been delivered, without having previously touched bat or person of the striker,

- bounces more than once or rolls along the ground before it reaches the popping crease.
- or pitches wholly or partially off the pitch as defined in clause 6.1 (Area of pitch) before it reaches the line of the striker's wicket.

21.8 Ball coming to rest in front of striker's wicket

If a ball delivered by the bowler comes to rest in front of the line of the striker's wicket, without having previously touched the bat or person of the striker, the umpire shall call and signal No ball and immediately call and signal Dead ball.

21.9 Fielder intercepting a delivery

If, except in the circumstances of clause 27.3 (Position of wicket-keeper) a ball delivered by the bowler, makes contact with any part of a fielder's person before it either makes contact with the striker's bat or person, or it passes the striker's wicket, the umpire shall call and signal No ball and immediately call and signal Dead ball.

21.10 Ball bouncing over head height of striker

See clauses 22.1.1.2, 41.6.4 and 41.6.5.

21.11 Call of No ball for infringement of other Playing Conditions

In addition to the instances above, No ball is to be called and signalled as required by the following clauses:

Clause 27.3 – Position of wicket-keeper

Clause 28.4 – Limitation of on side fielders

Clause 28.5 – Fielders not to encroach on pitch

Clause 41.6 – Bowling of dangerous and unfair short pitched deliveries

Clause 41.7 – Bowling of dangerous and unfair non-pitching deliveries

Clause 41.8 – Bowling of deliberate front foot No ball.

21.12 Revoking a call of No ball

An umpire shall revoke the call of No ball if Dead ball is called under any of clauses 20.4.2.4 to 20.4.2.9 (Umpire calling and signaling Dead ball). However, if a no ball is called in breach of clause 20.4.2.7 (41.4 - Deliberate attempt to distract striker before playing the ball or 41.5 – Deliberate attempt of Distraction, Deception or Obstruction of striker after the stroke) the No ball will stand.

21.13 No ball to over-ride Wide

A call of No ball shall over-ride the call of Wide ball at any time. See clauses 22.1 (Judging a Wide) and 22.2 (Call and signal of Wide ball).

21.14 Ball not dead

The ball does not become dead on the call of No ball.

21.15 Penalty for a No ball

A penalty of one run shall be awarded instantly on the call of No ball. Unless the call is revoked, the penalty shall stand even if a batsman is dismissed. It shall be in addition to any other runs scored, any boundary allowance and any other runs awarded for penalties.

21.16 Runs resulting from a No ball – how scored

The one run penalty shall be scored as a No ball extra and shall be debited against the bowler. If other Penalty runs have been awarded to either side these shall be scored as stated in clause 41.18 (Penalty runs). Any runs completed by the batsmen or any boundary allowance shall be credited to the striker if the ball has been struck by the bat; otherwise they shall also be scored as Byes or Leg byes as appropriate.

21.17 No ball not to count

A No ball shall not count as one of the over. See clause 17.3 (Validity of balls).

21.18 Out from a No ball

When No ball has been called, neither batsman shall be out under any of the Playing Conditions except clause 34 (Hit the ball twice), clause 37 (Obstructing the field) or clause 38 (Run out).

22 WIDE BALL**22.1 Judging a Wide**

- 22.1.1 If the bowler bowls a ball, not being a No ball, the umpire shall adjudge it a Wide if, according to the definition in clause 22.1.2
- 22.1.1.1 the ball passes wide of where the striker is standing and which also would have passed wide of the striker standing in a normal guard position.
- 22.1.1.2 the ball passes above the head height of the striker standing upright at the popping crease.
- 22.1.2 The ball will be considered as passing wide of the striker unless it is sufficiently within reach for him to be able to hit it with the bat by means of a normal cricket stroke.
- 22.1.3 For bowlers attempting to utilise the rough outside a batsman's leg stump, not necessarily as a negative tactic, the strict limited over Wide interpretation shall be applied.
- 22.1.4 For bowlers whom umpires consider to be bowling down the leg side as a negative tactic, the strict limited over Wide interpretation shall be applied.

22.2 Call and signal of Wide ball

If the umpire adjudges a delivery to be a Wide he/she shall call and signal Wide ball as soon as the ball passes the striker's wicket. It shall, however, be considered to have been a Wide from the instant that the bowler entered his delivery stride, even though it cannot be called Wide until it passes the striker's wicket.

22.3 Revoking a call of Wide ball

- 22.3.1 The umpire shall revoke the call of Wide ball if there is then any contact between the ball and the striker's bat or person before the ball comes into contact with any fielder.
- 22.3.2 The umpire shall revoke the call of Wide ball if a delivery is called a No ball. See clause 21.13 (No ball to over-ride Wide).

22.4 Delivery not a Wide

- 22.4.1 The umpire shall not adjudge a delivery as being a Wide, if the striker, by moving, either causes the ball to pass wide of him, as defined in clause 22.1.2 or brings the ball sufficiently within reach to be able to hit it by means of a normal cricket stroke.
- 22.4.2 The umpire shall not adjudge a delivery as being a Wide if the ball touches the striker's bat or person, but only as the ball passes the striker.

22.5 Ball not dead

The ball does not become dead on the call of Wide ball.

22.6 Penalty for a Wide

A penalty of one run shall be awarded instantly on the call of Wide ball. Unless the call is revoked, see clause 22.3, this penalty shall stand even if a batsman is dismissed, and shall be in addition to any other runs scored, any boundary allowance and any other runs awarded for penalties.

22.7 Runs resulting from a Wide – how scored

All runs completed by the batsmen or a boundary allowance, together with the penalty for the Wide, shall be scored as Wide balls. Apart from any award of 5 Penalty runs, all runs resulting from a Wide shall be debited against the bowler.

22.8 Wide not to count

A Wide shall not count as one of the over. See clause 17.3 (Validity of balls).

22.9 Out from a Wide

When Wide ball has been called, neither batsman shall be out under any of the Playing Conditions except clause 35 (Hit wicket), clause 37 (Obstructing the field), clause 38 (Run out) or clause 39 (Stumped).

23 BYE AND LEG BYE**23.1 Byes**

If the ball, delivered by the bowler, not being a Wide, passes the striker without touching his bat or person, any runs completed by the batsmen from that delivery, or a boundary allowance, shall be credited as Byes to the batting side. Additionally, if the delivery is a No ball, the one run penalty for such a delivery shall be incurred.

23.2 Leg byes

23.2.1 If a ball delivered by the bowler first strikes the person of the striker, runs shall be scored only if the umpire is satisfied that the striker has

either attempted to play the ball with the bat; or
tried to avoid being hit by the ball.

23.2.2 If the umpire is satisfied that either of these conditions has been met runs shall be scored as follows.

23.2.2.1 If there is

either no subsequent contact with the striker's bat or person, or

only inadvertent contact with the striker's bat or person, any runs completed by the batsmen or a boundary allowance shall be credited to the striker in the case of subsequent contact with his bat but otherwise to the batting side as in clause 23.2.3.

23.2.2.2 If the striker wilfully makes a lawful second strike, clause 34.3 (Ball lawfully struck more than once) and clause 34.4 (Runs permitted from ball lawfully struck more than once) shall apply.

23.2.3 The runs in clause 23.2.2.1, unless credited to the striker, shall be scored as Leg byes.

Additionally, if the delivery is a No ball, the one run penalty for the No ball shall be incurred.

23.3 Leg byes not to be awarded

If in the circumstance of clause 23.2.1 the umpire considers that neither of the conditions therein has been met, then Leg byes shall not be awarded.

If the ball does not become dead for any other reason, the umpire shall call and signal Dead ball as soon as the ball reaches the boundary or at the completion of the first run.

The umpire shall then:

- disallow all runs to the batting side;
- return any not out batsman to his original end;
- signal No ball to the scorers if applicable;
- award any 5-run Penalty that is applicable except for Penalty runs under clause 28.3 (Protective helmets belonging to the fielding side).

24 FIELDER'S ABSENCE; SUBSTITUTES**24.1 Substitute fielders**

24.1.1 The umpires shall allow a substitute fielder

24.1.1.1 if they are satisfied that a fielder has been injured or become ill and that this occurred during the match, or

24.1.1.2 for any other wholly acceptable reason.

In all other circumstances, a substitute is not allowed.

24.1.2 A substitute shall not bowl or act as captain but may act as wicket-keeper only with the consent of the umpires. Note, however, clause 42.4.1.

24.1.3 A nominated player may bowl or field even though a substitute has previously acted for him, subject to clauses 24.2 and 24.3.

24.1.4 Squad members of the fielding or batting team who are not playing in the match and who are not acting as substitute fielders shall be required to wear a team training bib whilst on the playing area (including the area between the boundary and the perimeter fencing).

24.2 Fielder absent or leaving the field of play

24.2.1 A player going briefly outside the boundary while carrying out any duties as a fielder is not absent from the field of play nor, for the purposes of this clause, is he to be regarded as having left the field of play.

24.2.2 If a fielder fails to take the field at the start of play or at any later time, or leaves the field during play,

24.2.2.1 an umpire shall be informed of the reason for this absence.

24.2.2.2 he shall not thereafter come on to the field of play during a session of play without the consent of the umpire. See clause 24.4. The umpire shall give such consent as soon as it is practicable.

24.2.3 If a player is absent from the field for longer than 8 minutes, the following restrictions shall apply to their future participation in the match:

24.2.3.1 The player shall not be permitted to bowl in the match until he has either been able to field, or his team has subsequently been batting, for the total length of playing time for which the player was absent (hereafter referred to as Penalty time). A player's unexpired Penalty time shall be limited to a maximum of 120 minutes. If any unexpired Penalty time remains at the end of an innings, it is carried forward to the next and subsequent innings of the match.

24.2.3.2 The player shall not be permitted to bat in the match until his team's batting innings has been in progress for the length of playing time that is equal to the unexpired Penalty time carried forward from the previous innings. However, once his side has lost five wickets in its batting innings, he may bat immediately. If any unexpired penalty time remains at the end of that batting innings, it is carried forward to the next and subsequent innings of the match.

24.2.4 If the player leaves the field before having served all of his Penalty time, the balance is carried forward as unserved Penalty time.

24.2.5 On any occasion of absence, the amount of playing time for which the player is off the field shall be added to any Penalty time that remains unserved, subject to a maximum cumulative Penalty time of 120 minutes, and that player shall not bowl until all of his Penalty time has been served.

24.2.6 For the purposes of clauses 24.2.3.1 and 24.2.3.2, playing time shall comprise the time play is in progress excluding lunch and tea intervals, intervals between innings and official drinks intervals. For clarity, a player's Penalty time will continue to expire after he is dismissed, for the remainder of his team's batting innings.

24.2.7 If there is an unscheduled break in play, the stoppage time shall count as Penalty time served, provided that,

24.2.7.1 the fielder who was on the field of play at the start of the break either takes the field on the resumption of play, or his side is now batting.

24.2.7.2 the fielder who was already off the field at the start of the break notifies an umpire in person as soon as he is able to participate, and either takes the field on the resumption of play, or his side is now batting. Stoppage time before an umpire has been so notified shall not count towards unserved Penalty time.

24.2.8 Any unserved Penalty time shall be carried forward into the next and subsequent days and innings of the match, as applicable.

24.3 Penalty time not incurred

A nominated player's absence will not incur Penalty time if,

24.3.1 he has suffered an external blow during the match and, as a result, has justifiably left the field or is unable to take the field.

24.3.2 in the opinion of the umpires, the player has been absent or has left the field for other wholly acceptable reasons, which shall not include illness or internal injury.

24.3.3 the player is absent from the field for a period of 8 minutes or less.

24.4 Player returning without permission

If a player comes on to the field of play in contravention of clause 24.2.2 and comes into contact with the ball while it is in play, the ball shall immediately become dead.

- The umpire shall award 5 Penalty runs to the batting side.
- Runs completed by the batsmen shall be scored together with the run in progress if they had already crossed at the instant of the offence.
- The ball shall not count as one of the over.
- The umpire shall inform the other umpire, the captain of the fielding side, the batsmen and, as soon as practicable, the captain of the batting side of the reason for this action.

25 BATSMAN'S INNINGS

25.1 Eligibility to act as a batsman

Only a nominated player may bat and, subject to clause 25.3, may do so even though a substitute fielder has previously acted for him.

25.2 Commencement of a batsman's innings

The innings of the first two batsmen, and that of any new batsman on the resumption of play after a call of Time, shall commence at the call of Play. At any other time, a batsman's innings shall be considered to have commenced when that batsman first steps onto the field of play.

25.3 Restriction on batsman commencing an innings

25.3.1 If a member of the batting side has unserved Penalty time (see clause 24.2.7) that player shall not be permitted to bat until that Penalty time has been served. However, even if the unserved Penalty time has not expired, that player may bat after his side has lost 5 wickets.

25.3.2 A member of the batting side's Penalty time is served during Playing time. In the event of an unscheduled stoppage, the stoppage time after the batsman notifies an umpire in person that he is able to participate shall count as Penalty time served.

25.3.3 If any unserved Penalty time remains at the end of a team's innings, it shall be carried forward to the next and subsequent innings of the match if appropriate.

25.4 Batsman retiring

25.4.1 A batsman may retire at any time during his innings when the ball is dead. The umpires, before allowing play to proceed, shall be informed of the reason for a batsman retiring.

25.4.2 If a batsman retires because of illness, injury or any other unavoidable cause, that batsman is entitled to resume his innings. If for any reason this does not happen, that batsman is to be recorded as 'Retired - not out'.

- 25.4.3 If a batsman retires for any reason other than as in clause 25.4.2, the innings of that batsman may be resumed only with the consent of the opposing captain. If for any reason his innings is not resumed, that batsman is to be recorded as 'Retired - out'.
- 25.4.4 If after retiring a batsman resumes his innings, subject to the requirements of clauses 25.4.2 and 25.4.3, it shall be only at the fall of a wicket or the retirement of another batsman.

25.5 Runners

Runners shall not be permitted.

26 PRACTICE ON THE FIELD

26.1 Practice on the pitch or the rest of the square

- 26.1.1 There shall not be any practice on the pitch at any time on any day of the match.
- 26.1.2 There shall not be any practice on the rest of the square at any time on any day of the match, except with the approval of the umpires.
- 26.1.2.1 If approved by the umpires, the use of the square for practice on any day of any match will be restricted to any netted practice area or bowling strips specifically prepared on the edge of the square for that purpose.
- 26.1.2.2 Bowling practice on the bowling strips referred to above shall also be permitted during the interval (and change of innings if not the interval) unless the umpires consider that, in the prevailing conditions of ground and weather, it will be detrimental to the surface of the square.

26.2 Practice on the outfield

- 26.2.1 On any day of the match, all forms of practice are permitted on the outfield
- before the start of play;
 - after the close of play; and
 - during the lunch and tea intervals or between innings,
- providing the umpires are satisfied that such practice will not cause significant deterioration in the condition of the outfield.
- 26.2.2 Between the call of Play and the call of Time, practice shall be permitted on the outfield, providing that all of the following conditions are met:
- only the fielders (as defined in paragraph 7 of Appendix A) participate in such practice.
 - no ball other than the match ball is used for this practice.
 - no bowling practice takes place in the area between the square and the boundary in a direction parallel to the match pitch.

- the umpires are satisfied that it will not contravene either of clauses 41.3 (The match ball changing its condition) or 41.9 (Time wasting by the fielding side).

Bowling a ball, using a short run up to a player in the outfield is not to be regarded as bowling practice but shall be subject to the other conditions in this clause.

26.3 Trial run-up

A bowler is permitted to have a trial run-up provided the umpire is satisfied that it will not contravene either of clauses 41.9 (Time wasting by the fielding side) or 41.12 (Fielder damaging the pitch).

26.4 Penalties for contravention

All forms of practice are subject to the provisions of clauses 41.13 (The match ball – changing its condition), 41.9 (Time wasting by the fielding side) and 41.12 (Fielder damaging the pitch).

- 26.4.1 If there is a contravention of any of the provisions of clause 26.1 or 26.2, the umpire shall
- warn the player that the practice is not permitted;
 - inform the other umpire and, as soon as practicable, both captains of the reason for this action.
- 26.4.1.1 If the contravention is by a batsman at the wicket, the umpire shall inform the other batsman and each incoming batsman that the warning has been issued. The warning shall apply to the team of that player throughout the match.
- 26.4.2 If during the match there is any further contravention by any player of that team, the umpire shall
- award 5 Penalty runs to the opposing side;
 - inform the other umpire, the scorers and, as soon as practicable, both captains, and, if the contravention is during play, the batsmen at the wicket.

27 THE WICKET-KEEPER

27.1 Protective equipment

The wicket-keeper is the only fielder permitted to wear gloves and external leg guards. If these are worn, they are to be regarded as part of his person for the purposes of clause 28.2 (Fielding the ball). If by the wicket-keeper's actions and positioning when the ball comes into play it is apparent to the umpires that he will not be able to carry out the normal duties of a wicket-keeper, he shall forfeit this right and also the right to be recognised as a wicket-keeper for the purposes of clauses 33.2 (A fair catch), 39 (Stumped), 28.1 (Protective equipment), 28.4 (Limitation of on-side fielders) and 28.5 (Fielders not to encroach on pitch).

27.2 Gloves

- 27.2.1 If, as permitted under clause 27.1, the wicket-keeper wears gloves, they shall have no webbing between the fingers except joining index finger and thumb, where webbing may be inserted as a means of support.
- 27.2.2 If used, the webbing shall be a single piece of non-stretch material which, although it may have facing material attached, shall have no reinforcements or tucks.
- 27.2.3 The top edge of the webbing shall not protrude beyond the straight line joining the top of the index finger to the top of the thumb and shall be taut when a hand wearing the glove has the thumb fully extended. See paragraph 3 of Appendix B.

27.3 Position of wicket-keeper

- 27.3.1 The wicket-keeper shall remain wholly behind the wicket at the striker's end from the moment the ball comes into play until a ball delivered by the bowler:
- touches the bat or person of the striker; or
 - passes the wicket at the striker's end; or
 - the striker attempts a run.
- 27.3.2 In the event of the wicket-keeper contravening this clause, the striker's end umpire shall call and signal No ball as soon as applicable after the delivery of the ball.

27.4 Movement by wicket-keeper

- 27.4.1 After the ball comes into play and before it reaches the striker, it is unfair if the wicket-keeper significantly alters his position in relation to the striker's wicket, except for the following:
- 27.4.1.1 movement of a few paces forward for a slower delivery, unless in so doing it brings him within reach of the wicket.
 - 27.4.1.2 lateral movement in response to the direction in which the ball has been delivered.
 - 27.4.1.3 movement in response to the stroke that the striker is playing or that his actions suggest he intends to play. However the provisions of clause 27.3 shall apply.
- 27.4.2 In the event of unfair movement by the wicket-keeper, either umpire shall call and signal Dead ball.

27.5 Restriction on actions of wicket-keeper

If, in the opinion of either umpire, the wicket-keeper interferes with the striker's right to play the ball and to guard his wicket, clause 20.4.2.6 (Umpire calling and signalling Dead ball) shall apply.

If, however, either umpire considers that the interference by the wicket-keeper was wilful, then clause 41.4 (Deliberate attempt to distract striker) shall also apply.

27.6 Interference with wicket-keeper by striker

If, in playing at the ball or in the legitimate defence of his wicket, the striker interferes with the wicket-keeper, he shall not be out except as provided for in clause 37.3 (Obstructing a ball from being caught).

28 THE FIELDER**28.1 Protective equipment**

No fielder other than the wicket-keeper shall be permitted to wear gloves or external leg guards. In addition, protection for the hand or fingers may be worn only with the consent of the umpires.

28.2 Fielding the ball

- 28.2.1 A fielder may field the ball with any part of his person (see paragraph 12 of Appendix A), except as in clause 28.2.1.2. However, he will be deemed to have fielded the ball illegally if, while the ball is in play he wilfully:
- 28.2.1.1 uses anything other than part of his person to field the ball.
 - 28.2.1.2 extends his clothing with his hands and uses this to field the ball.
 - 28.2.1.3 discards a piece of clothing, equipment or any other object which subsequently makes contact with the ball.
- 28.2.2 It is not illegal fielding if the ball in play makes contact with a piece of clothing, equipment or any other object which has accidentally fallen from the fielder's person.
- 28.2.3 If a fielder illegally fields the ball, the ball shall immediately become dead and
- the penalty for a No ball or a Wide shall stand.
 - any runs completed by the batsmen shall be credited to the batting side, together with the run in progress if the batsmen had already crossed at the instant of the offence.
 - the ball shall not count as one of the over.
- In addition the umpire shall:
- award 5 Penalty runs to the batting side.
 - inform the other umpire and the captain of the fielding side of the reason for this action.
 - inform the batsmen and, as soon as practicable, the captain of the batting side of what has occurred.

28.3 Protective helmets belonging to the fielding side

- 28.3.1 Protective helmets, when not in use by fielders, may not be placed on the ground, above the surface except behind the wicket-keeper and in line with both sets of stumps.
- 28.3.2 If the ball while in play strikes a helmet, placed as described in clause 28.3.1,
- 28.3.2.1 the ball shall become dead
and, subject to clause 28.3.3,
- 28.3.2.2 an award of 5 Penalty runs shall be made to the batting side;
- 28.3.2.3 any runs completed by the batsmen before the ball strikes the protective helmet shall be scored, together with the run in progress if the batsmen had already crossed at the instant of the ball striking the protective helmet.
- 28.3.3 If the ball while in play strikes a helmet, placed as described in clause 28.3.1, unless the circumstances of clause 23.3 (Leg byes not to be awarded) or clause 34 (Hit the ball twice), apply, the umpire shall:
- permit the batsmen's runs as in clause 28.3.2.3 to be scored
 - signal No ball or Wide ball to the scorers if applicable
 - award 5 Penalty runs as in clause 28.3.2.2
 - award any other Penalty runs due to the batting side.
- 28.3.4 If the ball while in play strikes a helmet, placed as described in clause 28.3.1, and the circumstances of clause 23.3 (Leg byes not to be awarded) or clause 34 (Hit the ball twice) apply, the umpire shall:
- disallow all runs to the batting side
 - return any not out batsman to his original end
 - signal No ball or Wide ball to the scorers if applicable
 - award any 5-run Penalty that is applicable except for Penalty runs under clause 28.3.2.

28.4 Limitation of on side fielders

At the instant of the bowler's delivery there shall not be more than two fielders, other than the wicket-keeper, behind the popping crease on the on side. A fielder will be considered to be behind the popping crease unless the whole of his person whether grounded or in the air is in front of this line.

In the event of infringement of this clause by any fielder, the striker's end umpire shall call and signal No ball.

28.5 Fielders not to encroach on pitch

While the ball is in play and until the ball has made contact with the striker's bat or person, or has passed the striker's bat, no fielder, other than the bowler, may have any part of his person grounded on or extended over the pitch.

In the event of infringement of this clause by any fielder other than the wicket-keeper, the bowler's end umpire shall call and signal No ball as soon as possible after delivery of the ball. Note, however, clause 27.3 (Position of wicket-keeper).

28.6 Movement by any fielder other than the wicket-keeper

- 28.6.1 Any movement by any fielder, excluding the wicket-keeper, after the ball comes into play and before the ball reaches the striker, is unfair except for the following:
- 28.6.1.1 minor adjustments to stance or position in relation to the striker's wicket.
- 28.6.1.2 movement by any fielder, other than a close fielder, towards the striker or the striker's wicket that does not significantly alter the position of the fielder.
- 28.6.1.3 movement by any fielder in response to the stroke that the striker is playing or that his actions suggest he intends to play.
- 28.6.2 In all circumstances clause 28.4 (Limitation of on side fielders) shall apply.
- 28.6.3 In the event of such unfair movement, either umpire shall call and signal Dead ball.
- 28.6.4 Note also the provisions of clause 41.4 (Deliberate attempt to distract striker). See also clause 27.4 (Movement by wicket-keeper).

29 THE WICKET IS DOWN**29.1 Wicket put down**

- 29.1.1 The wicket is put down if a bail is completely removed from the top of the stumps, or a stump is struck out of the ground,
- 29.1.1.1 by the ball,
- 29.1.1.2 by the striker's bat if held or by any part of the bat that he is holding,
- 29.1.1.3 for the purpose of this clause only, by the striker's bat not in hand, or by any part of the bat which has become detached,
- 29.1.1.4 by the striker's person or by any part of his clothing or equipment becoming detached from his person,
- 29.1.1.5 by a fielder with his hand or arm, providing that the ball is held in the hand or hands so used, or in the hand of the arm so used.
- 29.1.1.6 The wicket is also put down if a fielder strikes or pulls a stump out of the ground as in clause 29.1.1.5.

- 29.12 The disturbance of a bail, whether temporary or not, shall not constitute its complete removal from the top of the stumps, but if a bail in falling lodges between two of the stumps this shall be regarded as complete removal.

29.2 One bail off

If one bail is off, it shall be sufficient for the purpose of putting the wicket down to remove the remaining bail or to strike or pull any of the three stumps out of the ground, in any of the ways stated in clause 29.1.

29.3 Remaking wicket

If a wicket is broken or put down while the ball is in play, it shall not be remade by an umpire until the ball is dead. See clause 20 (Dead ball).

Any fielder may, however, while the ball is in play,

- replace a bail or bails on top of the stumps.
- put back one or more stumps into the ground where the wicket originally stood.

29.4 Dispensing with bails

If the umpires have agreed to dispense with bails in accordance with clause 8.4 (Dispensing with bails), it is for the umpire concerned to decide whether or not the wicket has been put down.

- 29.4.1 After a decision to play without bails, the wicket has been put down if the umpire concerned is satisfied that the wicket has been struck by the ball, by the striker's bat, person or items of his clothing or equipment as described in clauses 29.1.1.2, 29.1.1.3 or 29.1.1.4, or by a fielder in the manner described in clause 29.1.1.5.
- 29.4.2 If the wicket has already been broken or put down, clause 29.4.1 shall apply to any stump or stumps still in the ground. Any fielder may replace a stump or stumps, in accordance with clause 29.3, in order to have an opportunity of putting the wicket down.

30 BATSMAN OUT OF HIS GROUND

30.1 When out of his ground

- 30.1.1 A batsman shall be considered to be out of his ground unless some part of his person or bat is grounded behind the popping crease at that end.
- 30.1.2 However, a batsman shall not be considered to be out of his ground if, in running or diving towards his ground and beyond, and having grounded some part of his person or bat beyond the popping crease, there is subsequent loss of contact between the ground and any part of his person or bat, or between the bat and person.

30.2 Which is a batsman's ground

- 30.2.1 If only one batsman is within a ground, it is his ground and will remain so even if he is later joined there by the other batsman.
- 30.2.2 If both batsmen are in the same ground and one of them subsequently leaves it, the ground belongs to the batsman who remains in it.
- 30.2.3 If there is no batsman in either ground, then each ground belongs to whichever batsman is nearer to it, or, if the batsmen are level, to whichever batsman was nearer to it immediately prior to their drawing level.
- 30.2.4 If a ground belongs to one batsman then the other ground belongs to the other batsman, irrespective of his position.

30.3 Position of non-striker

The non-striker, when standing at the bowler's end, should be positioned on the opposite side of the wicket to that from which the ball is being delivered, unless a request to do otherwise is granted by the umpire.

31 APPEALS

31.1 Umpire not to give batsman out without an appeal

Neither umpire shall give a batsman out, even though he may be out under these Playing Conditions, unless appealed to by a fielder. This shall not debar a batsman who is out under these Playing Conditions from leaving the wicket without an appeal having been made. Note, however, the provisions of clause 31.7.

31.2 Batsman dismissed

A batsman is dismissed if he is

either given out by an umpire, on appeal

or out under these Playing Conditions and leaves the wicket as in clause 31.1.

31.3 Timing of appeals

For an appeal to be valid, it must be made before the bowler begins his run-up or, if there is no run-up, his bowling action to deliver the next ball, and before Time has been called.

The call of Over does not invalidate an appeal made prior to the start of the following over, provided Time has not been called. See clauses 12.2 (Call of Time) and 17.2 (Start of an over).

31.4 Appeal "How's That?"

An appeal "How's That?" covers all ways of being out.

31.5 Answering appeals

The striker's end umpire shall answer all appeals arising out of any of clauses 35 (Hit wicket), 39 (Stumped) or 38 (Run out) when this occurs at the wicket-keeper's end. The bowler's end umpire shall answer all other appeals.

When an appeal is made, each umpire shall answer on any matter that falls within his jurisdiction.

When a batsman has been given Not out, either umpire may answer an appeal, made in accordance with clause 31.3, if it is on a further matter and is within his jurisdiction.

31.6 Consultation by umpires

Each umpire shall answer appeals on matters within his own jurisdiction. If an umpire is doubtful about any point that the other umpire may have been in a better position to see, he/she shall consult the latter on this point of fact and shall then give the decision. If, after consultation, there is still doubt remaining, the decision shall be Not out.

31.7 Batsman leaving the wicket under a misapprehension

An umpire shall intervene if satisfied that a batsman, not having been given out, has left the wicket under a misapprehension of being out. The umpire intervening shall call and signal Dead ball to prevent any further action by the fielding side and shall recall the batsman.

A batsman may be recalled at any time up to the instant when the ball comes into play for the next delivery, unless it is the final wicket of the innings, in which case it should be up to the instant when the umpires leave the field.

31.8 Withdrawal of an appeal

The captain of the fielding side may withdraw an appeal only after obtaining the consent of the umpire within whose jurisdiction the appeal falls. If such consent is given, the umpire concerned shall, if applicable, revoke the decision and recall the batsman.

The withdrawal of an appeal must be before the instant when the ball comes into play for the next delivery or, if the innings has been completed, the instant when the umpires leave the field.

32 BOWLED**32.1 Out Bowled**

32.1.1 The striker is out Bowled if his wicket is put down by a ball delivered by the bowler, not being a No ball, even if it first touches the striker's bat or person.

32.1.2 However, the striker shall not be out Bowled if before striking the wicket the ball has been in contact with any other player or an umpire. The striker will, however, be subject to clauses 37 (Obstructing the field), 38 (Run out) and 39 (Stumped).

32.2 Bowled to take precedence

The striker is out Bowled if his wicket is put down as in clause 32.1, even though a decision against him for any other method of dismissal would be justified.

33 CAUGHT**33.1 Out Caught**

The striker is out Caught if a ball delivered by the bowler, not being a No ball, touches his bat without having previously been in contact with any fielder, and is subsequently held by a fielder as a fair catch, as described in clauses 33.2 and 33.3, before it touches the ground.

33.2 A fair catch

33.2.1 A catch will be fair only if, in every case either the ball, at any time

or any fielder in contact with the ball,

is not grounded beyond the boundary before the catch is completed. Note clauses 19.4 (Ball grounded beyond the boundary) and 19.5 (Fielder grounded beyond the boundary).

33.2.2 Furthermore, a catch will be fair if any of the following conditions applies:

33.2.2.1 the ball is held in the hand or hands of a fielder, even if the hand holding the ball is touching the ground, or is hugged to the body, or lodges in the external protective equipment worn by a fielder, or lodges accidentally in a fielder's clothing.

33.2.2.2 a fielder catches the ball after it has been lawfully struck more than once by the striker, but only if it has not been grounded since it was first struck. See clause 34 (Hit the ball twice).

33.2.2.3 a fielder catches the ball after it has touched the wicket, an umpire, another fielder or the other batsman.

33.2.2.4 a fielder catches the ball after it has crossed the boundary in the air, provided that the conditions in clause 33.2.1 are met.

33.2.2.5 the ball is caught off an obstruction within the boundary that is not designated a boundary by the umpires.

33.3 Making a catch

The act of making a catch shall start from the time when the ball first comes into contact with a fielder's person and shall end when a fielder obtains complete control over both the ball and his own movement.

33.4 No runs to be scored

If the striker is dismissed Caught, runs from that delivery completed by the batsmen before the completion of the catch shall not be scored but any runs for penalties awarded to either side shall stand. Clause 18.12 (Batsman returning to wicket he has left) shall apply from the instant of the completion of the catch.

33.5 Caught to take precedence

If the criteria of clause 33.1 are met and the striker is not out Bowled, then he is out Caught, even though a decision against either batsman for another method of dismissal would be justified.

34 HIT THE BALL TWICE**34.1 Out Hit the ball twice**

- 34.1.1 The striker is out Hit the ball twice if, while the ball is in play, it strikes any part of his person or is struck by his bat and, before the ball has been touched by a fielder, the striker wilfully strikes it again with his bat or person, other than a hand not holding the bat, except for the sole purpose of guarding his wicket. See clause 34.3 and clause 37 (Obstructing the field).
- 34.1.2 For the purpose of this clause 'struck' or 'strike' shall include contact with the person of the striker.

34.2 Not out Hit the ball twice

The striker will not be out under this clause if he:

- 34.2.1 strikes the ball a second or subsequent time in order to return the ball to any fielder.
- Note, however, the provisions of clause 37.4 (Returning the ball to a fielder).
- 34.2.2 wilfully strikes the ball after it has touched a fielder. Note, however the provisions of clause 37.1 (Out Obstructing the field).

34.3 Ball lawfully struck more than once

The striker may, solely in order to guard his wicket and before the ball has been touched by a fielder, lawfully strike the ball a second or subsequent time with the bat, or with any part of his person other than a hand not holding the bat. The striker may guard his wicket even if the delivery is a No ball.

However, the striker may not prevent the ball from being caught by striking the ball more than once in defence of his wicket. See clause 37.3 (Obstructing a ball from being caught).

34.4 Runs permitted from ball lawfully struck more than once

When the ball is lawfully struck more than once, as permitted in clause 34.3, if the ball does not become dead for any reason, the umpire shall call and signal Dead ball as soon as the ball reaches the boundary or at the completion of the first run. However, the umpire shall delay the call of Dead ball to allow the opportunity for a catch to be completed.

The umpire shall

- disallow all runs to the batting side;
- return any not out batsman to his original end;
- signal No ball to the scorers if applicable; and
- award any 5-run Penalty that is applicable except for Penalty runs under clause 28.3 (Protective helmets belonging to the fielding side).

34.5 Bowler does not get credit

The bowler does not get credit for the wicket.

35 HIT WICKET**35.1 Out Hit wicket**

- 35.1.1 The striker is out Hit wicket if, after the bowler has entered the delivery stride and while the ball is in play, his wicket is put down by either the striker's bat or person as described in clauses 29.1.1.2 to 29.1.1.4 (Wicket put down) in any of the following circumstances:
- 35.1.1.1 in the course of any action taken by him in preparing to receive or in receiving a delivery,
- 35.1.1.2 in setting off for the first run immediately after playing or playing at the ball,
- 35.1.1.3 if no attempt is made to play the ball, in setting off for the first run, providing that in the opinion of the umpire this is immediately after the striker has had the opportunity of playing the ball,
- 35.1.1.4 in lawfully making a second or further stroke for the purpose of guarding his wicket within the provisions of clause 34.3 (Ball lawfully struck more than once).
- 35.1.2 If the striker puts his wicket down in any of the ways described in clauses 29.1.1.2 to 29.1.1.4 before the bowler has entered the delivery stride, either umpire shall call and signal Dead ball.

35.2 Not out Hit wicket

The striker is not out under this clause should his wicket be put down in any of the ways referred to in clause 35.1 if any of the following applies:

- it occurs after the striker has completed any action in receiving the delivery, other than in clauses 35.1.1.2 to 35.1.1.4.
- it occurs when the striker is in the act of running, other than setting off immediately for the first run.
- it occurs when the striker is trying to avoid being run out or stumped.
- it occurs when the striker is trying to avoid a throw in at any time.
- the bowler after entering the delivery stride does not deliver the ball. In this case either umpire shall immediately call and signal Dead ball. See clause 20.4 (Umpire calling and signalling Dead ball).
- the delivery is a No ball.

36 LEG BEFORE WICKET**36.1 Out LBW**

The striker is out LBW if all the circumstances set out in clauses 36.1.1 to 36.1.5 apply:

- 36.1.1 The bowler delivers a ball, not being a No ball
- 36.1.2 the ball, if it is not intercepted full-pitch, pitches in line between wicket and wicket or on the off side of the striker's wicket

- 36.13 the ball not having previously touched his bat, the striker intercepts the ball, either full-pitch or after pitching, with any part of his person
- 36.14 the point of impact, even if above the level of the bails, either is between wicket and wicket
or if the striker has made no genuine attempt to play the ball with the bat, is
between wicket and wicket or outside the line of the off stump.
- 36.15 but for the interception, the ball would have hit the wicket.

36.2 Interception of the ball

- 36.2.1 In assessing points of impact in clauses 36.1.3, 36.1.4 and 36.1.5, only the first interception is to be considered.
- 36.2.2 In assessing 36.1.3, if the bowler's end umpire is not satisfied that the ball intercepted the batsman's person before it touched the bat, the batsman shall be given Not out.
- 36.2.3 In assessing clause 36.1.5, it is to be assumed that the path of the ball before interception would have continued after interception, irrespective of whether the ball might have pitched subsequently or not.

36.3 Off side of wicket

The off side of the striker's wicket shall be determined by the striker's stance at the moment the ball comes into play for that delivery. See paragraph 13 of Appendix A.

37 OBSTRUCTING THE FIELD

37.1 Out Obstructing the field

- 37.1.1 Either batsman is out Obstructing the field if, except in the circumstances of clause 37.2, and while the ball is in play, he wilfully attempts to obstruct or distract the fielding side by word or action. See also clause 34 (Hit the ball twice).
- 37.1.2 The striker is out Obstructing the field if, except in the circumstances of clause 37.2, in the act of receiving a ball delivered by the bowler, he wilfully strikes the ball with a hand not holding the bat. This will apply whether it is the first strike or a second or subsequent strike. The act of receiving the ball shall extend both to playing at the ball and to striking the ball more than once in defence of his wicket.
- 37.1.3 This clause will apply whether or not No ball is called.
- 37.1.4 For the avoidance of doubt, if an umpire feels that a batsman, in running between the wickets, has significantly changed his direction without probable cause and thereby obstructed a fielder's attempt to effect a run out, the batsman should, on appeal, be given out, obstructing the field. It shall not be relevant whether a run out would have occurred or not.
- If the change of direction involves the batsman crossing the pitch, clause 41.14 shall also apply.
- See also paragraph 2.2 of Appendix D.

37.2 Not out Obstructing the field

A batsman shall not be out Obstructing the field if obstruction or distraction is accidental, or obstruction is in order to avoid injury, or

in the case of the striker, he makes a second or subsequent strike to guard his wicket lawfully as in clause 34.3 (Ball lawfully struck more than once). However, see clause 37.3.

37.3 Obstructing a ball from being caught

- 37.3.1 If the delivery is not a No ball, the striker is out Obstructing the field if wilful obstruction or distraction by either batsman prevents the striker being out Caught.
- 37.3.2 Clause 37.3.1 shall apply even if an obstruction is caused by the striker in lawfully guarding his wicket under the provision of Clause 34.3 (Ball lawfully struck more than once).
- 37.3.3 If an obstruction or distraction takes place from a No ball then the batsman who caused the obstruction or distraction will be out Obstructing the field.
- 37.3.4 Clause 37.3.3 shall not apply if the striker obstructs while instinctively defending his wicket with a lawful second strike.

37.4 Returning the ball to a fielder

Either batsman is out Obstructing the field if, at any time while the ball is in play and, without the consent of a fielder, he uses the bat or any part of his person to return the ball to any fielder.

37.5 Runs scored

When either batsman is dismissed Obstructing the field,

- 37.5.1 unless the obstruction prevents a catch from being made, any runs completed by the batsmen before the offence shall be scored, together with any runs awarded for penalties to either side. See clauses 18.6 (Runs awarded for penalties) and 18.8 (Runs scored when a batsman is dismissed).
- 37.5.2 if the obstruction prevents a catch from being made, any runs completed by the batsmen shall not be scored but any penalties awarded to either side shall stand.

37.6 Bowler does not get credit

The bowler does not get credit for the wicket.

38 RUN OUT

38.1 Out Run out

Either batsman is out Run out, except as in clause 38.2, if, at any time while the ball is in play,
he is out of his ground
and his wicket is fairly put down by the action of a fielder
even though No ball has been called, except in the circumstances of clause 38.2.2.2, and whether or not a run is being attempted.

38.2 Batsman not out Run out

- 38.2.1 A batsman is not out Run out in the circumstances of clauses 38.2.1.1 or 38.2.1.2.
- 38.2.1.1 He has been within his ground and has subsequently left it to avoid injury, when the wicket is put down.
Note also the provisions of clause 30.1.2 (When out of his ground).
- 38.2.1.2 The ball, delivered by the bowler, has not made contact with a fielder before the wicket is put down.
- 38.2.2 The striker is not out Run out in any of the circumstances in clauses 38.2.2.1 and 38.2.2.2.
- 38.2.2.1 He is out Stumped. See clause 39.1.2 (Out Stumped).
- 38.2.2.2 No ball has been called
and he is out of his ground not attempting a run
and the wicket is fairly put down by the wicket-keeper without the intervention of another fielder.

38.3 Which batsman is out

The batsman out in the circumstances of clause 38.1 is the one whose ground is at the end where the wicket is put down. See clause 30.2 (Which is a batsman's ground).

38.4 Runs scored

If either batsman is dismissed Run out, the run in progress when the wicket is put down shall not be scored, but any runs completed by the batsmen shall stand, together with any runs for penalties awarded to either side. See clauses 18.6 (Runs awarded for penalties) and 18.8 (Runs scored when a batsman is dismissed).

38.5 Bowler does not get credit

The bowler does not get credit for the wicket.

39 STUMPED**39.1 Out Stumped**

- 39.1.1 The striker is out Stumped, except as in clause 39.3, if:
a ball which is delivered is not called No ball
and he is out of his ground, other than as in clause 39.3.1
and he has not attempted a run
when his wicket is fairly put down by the wicket-keeper without the intervention of another fielder. Note, however clause 27.3 (Position of wicket-keeper).
- 39.1.2 The striker is out Stumped if all the conditions of clause 39.1.1 are satisfied, even though a decision of Run out would be justified.

39.2 Ball rebounding from wicket-keeper's person

If the wicket is put down by the ball, it shall be regarded as having been put down by the wicket-keeper if the ball rebounds on to the stumps from any part of the wicket-keeper's person or equipment or has been kicked or thrown on to the stumps by the wicket-keeper.

39.3 Not out Stumped

- 39.3.1 The striker will not be out Stumped if, after having received the delivery he has left his ground in order to avoid injury.
- 39.3.2 If the striker is not out Stumped he may, except in the circumstances of clause 38.2.2.2 (Batsman not out Run out), be out Run out if the conditions of clause 38.1 (Out Run out) apply.

40 TIMED OUT**40.1 Out Timed out**

- 40.1.1 After the fall of a wicket or the retirement of a batsman, the incoming batsman must, unless Time has been called, be in position to take guard or for the other batsman to be ready to receive the next ball within 3 minutes of the dismissal or retirement. If this requirement is not met, the incoming batsman will be out, Timed out.
- 40.1.2 In the event of an extended delay in which no batsman comes to the wicket, the umpires shall adopt the procedure of clause 16.2 (ICC Match Referee awarding a match). For the purposes of that clause the start of the action shall be taken as the expiry of the 3 minutes referred to above.

40.2 Bowler does not get credit

The bowler does not get credit for the wicket.

41 UNFAIR PLAY**41.1 Fair and unfair play – responsibility of captains**

The captains are responsible for ensuring that play is conducted within the Spirit of Cricket, as well as within these Playing Conditions.

41.2 Fair and unfair play – responsibility of umpires

- 41.2.1 The umpires shall be the sole judges of fair and unfair play. If either umpire considers that any action by a player, not covered by these Playing Conditions, is unfair, he/she shall call and signal Dead ball, if appropriate, as soon as it becomes clear that the call will not disadvantage the non-offending side, and report the matter to the other umpire.
- 41.2.1.1 If this is a first offence by that side, the bowler's end umpire shall then
- summon the offending player's captain and issue a first and final warning which shall apply to all members of the team for the remainder of the match.
 - warn the offending player's captain that any further such offence by any member of his team shall result in the award of 5 Penalty runs to the opposing team.

- 41.2.1.2 If this is a second or subsequent offence by that side, the bowler's end umpire shall then
- summon the offending player's captain and inform him that there has been a further such offence.
 - award 5 Penalty runs to the opposing side.
- 41.2.1.3 The umpires may then report the matter to the ICC Match Referee who shall take such action as is considered appropriate against the player concerned.

41.3 The match ball – changing its condition

41.3.1 The umpires shall make frequent and irregular inspections of the ball. In addition, they shall immediately inspect the ball if they suspect anyone of attempting to change the condition of the ball, except as permitted in clause 41.3.2.

41.3.2 It is an offence for any player to take any action which changes the condition of the ball.

Except in carrying out his normal duties, a batsman is not allowed to wilfully damage the ball other than, when the ball is in play, in striking it with the bat. See also clause 5.5 (Damage to the ball).

A fielder may, however:

- 41.3.2.1 polish the ball on his clothing provided that no artificial substance is used and that such polishing wastes no time.
- 41.3.2.2 remove mud from the ball under the supervision of an umpire.
- 41.3.2.3 dry a wet ball on a piece of cloth that has been approved by the umpires.

41.3.3 The umpires shall consider the condition of the ball to have been unfairly changed if any action by any player does not comply with the conditions in clause 41.3.2.

41.3.4 If the umpires together agree that the condition of the ball has been unfairly changed by a member or members of either side, or that its condition is inconsistent with the use it has received, they shall consider that there has been a contravention of this clause and decide together whether they can identify the player(s) responsible for such conduct.

41.3.5 If it is possible to identify the player(s) responsible for changing the condition of the ball, the umpires shall:

- 41.3.5.1 Change the ball forthwith.
- 41.3.5.1.1 If the umpires together agree that the condition of the ball has been unfairly changed by a member or members of the fielding side, the batsman at the wicket shall choose the replacement ball from a selection of six other balls of various degrees of usage (including a new ball) and of the same brand as the ball in use prior to the contravention.

41.3.5.1.2 If the umpires together agree that the condition of the ball has been unfairly changed by a member or members of the batting side, the umpires shall select and bring into use immediately, a ball which shall have wear comparable to that of the previous ball immediately prior to the contravention.

41.3.5.2 Additionally, the bowler's end umpire shall:

- award 5 Penalty runs to the opposing side.
- if appropriate, inform the batsmen at the wicket and the captain of the fielding side that the ball has been changed and the reason for their action.
- inform the captain of the batting side as soon as practicable of what has occurred.

The umpires shall then report the matter to the ICC Match Referee who shall take such action as is considered appropriate against the player(s) concerned.

41.3.6 If it is not possible to identify the player(s) responsible for changing the condition of the ball, the umpires shall:

- 41.3.6.1 Change the ball forthwith. The umpires shall choose the replacement ball for one of similar wear and of the same brand as the ball in use prior to the contravention.
- 41.3.6.2 The bowler's end umpire shall issue the captain with a first and final warning, and
- 41.3.6.3 Advise the captain that should there be any further instances of changing the condition of the ball by that team during the remainder of the series, clause 41.3.5.2 above will be adopted, with the captain deemed to be the player responsible for the contravention.

41.4 Deliberate attempt to distract striker

41.4.1 It is unfair for any fielder deliberately to attempt to distract the striker while he is preparing to receive or receiving a delivery.

41.4.2 If either umpire considers that any action by a fielder is such an attempt, he/she shall immediately call and signal Dead ball and inform the other umpire of the reason for the call. The bowler's end umpire shall

- award 5 Penalty runs to the batting side.
- inform the captain of the fielding side, the batsmen and, as soon as practicable, the captain of the batting side of the reason for the action.

Neither batsman shall be dismissed from that delivery and the ball shall not count as one of the over.

The umpires may then report the matter to the ICC Match Referee who shall take such action as is considered appropriate against the fielder concerned.

41.5 Deliberate distraction, deception or obstruction of batsman

- 41.5.1 In addition to clause 41.4, it is unfair for any fielder wilfully to attempt, by word or action, to distract, deceive or obstruct either batsman after the striker has received the ball.
- 41.5.2 It is for either one of the umpires to decide whether any distraction, deception or obstruction is wilful or not.
- 41.5.3 If either umpire considers that a fielder has caused or attempted to cause such a distraction, deception or obstruction, he/she shall immediately call and signal Dead ball and inform the other umpire of the reason for the call.
- 41.5.4 Neither batsman shall be dismissed from that delivery.
- 41.5.5 If an obstruction involves physical contact, the umpires together shall decide whether or not an offence under clause 42 (Players' conduct) has been committed.
- 41.5.5.1 If an offence under clause 42 (Players' conduct) has been committed, they shall apply the relevant procedures in clause 42 and shall also apply each of clauses 41.5.7 to 41.5.9.
- 41.5.5.2 If they consider that there has been no offence under clause 42 (Players' conduct), they shall apply each of clauses 41.5.6 to 41.5.10.
- 41.5.6 The bowler's end umpire shall:
- award 5 Penalty runs to the batting side.
 - inform the captain of the fielding side of the reason for this action and as soon as practicable inform the captain of the batting side.
- 41.5.7 The ball shall not count as one of the over.
- 41.5.8 Any runs completed by the batsmen before the offence shall be scored, together with any runs for penalties awarded to either side. Additionally, the run in progress shall be scored whether or not the batsmen had already crossed at the instant of the offence.
- 41.5.9 The batsmen at the wicket shall decide which of them is to face the next delivery.
- 41.5.10 The umpires may then report the matter to the ICC Match Referee who shall take such action as is considered appropriate against the fielder concerned.

41.6 Bowling of dangerous and unfair short pitched deliveries

- 41.6.1 Notwithstanding clause 41.6.2, the bowling of short pitched deliveries is dangerous if the bowler's end umpire considers that, taking into consideration the skill of the striker, by their speed, length, height and direction they are likely to inflict physical injury on him. The fact that the striker is wearing protective equipment shall be disregarded.

In the first instance the umpire decides that the bowling of short pitched deliveries has become dangerous under 41.6.1:

- 41.6.1.1 The umpire shall call and signal No ball, and when the ball is dead, caution the bowler and inform the other umpire, the captain of the fielding side and the batsmen of what has occurred. This caution shall apply to that bowler throughout the innings.
- 41.6.1.2 If there is a second instance, the umpire shall repeat the above procedure and indicate to the bowler that this is a final warning, which shall apply to that bowler throughout the innings.
- 41.6.1.3 Should there be any further instance by the same bowler in that innings, the umpire shall:
- call and signal No ball
 - when the ball is dead, direct the captain of the fielding side to suspend the bowler immediately from bowling
 - inform the other umpire for the reason for this action.
- The bowler thus suspended shall not be allowed to bowl again in that innings.
- If applicable, the over shall be completed by another bowler, who shall neither have bowled any part of the previous over, nor be allowed to bowl any part of the next over.
- The umpire shall report the occurrence to the batsmen and, as soon as practicable, to the captain of the batting side.
- The umpires may then report the matter to the ICC Match Referee who shall take such action as is considered appropriate against the bowler concerned.
- 41.6.2 A bowler shall be limited to two fast short-pitched deliveries per over.
- 41.6.3 A fast short-pitched delivery is defined as a ball, which passes or would have passed above the shoulder height of the striker standing upright at the popping crease.
- 41.6.4 The umpire at the bowler's end shall advise the bowler and the batsman on strike when each fast short pitched delivery has been bowled.
- 41.6.5 In addition, a ball that passes above head height of the batsman, standing upright at the popping crease, that prevents him from being able to hit it with his bat by means of a normal cricket stroke shall be called a Wide. See also clause 22.1.1.2
- 41.6.5.1 For the avoidance of doubt any fast short pitched delivery that is called a Wide under this playing condition shall also count as one of the allowable short pitched deliveries in that over.

- 41.6.6 In the event of a bowler bowling more than two fast short-pitched deliveries in an over as defined in clause 41.6.3 above, the umpire at the bowler's end shall call and signal No ball on each occasion. A differential signal shall be used to signify a fast short pitched delivery. The umpire shall call and signal 'No ball' and then tap the head with the other hand.
- 41.6.7 If a bowler delivers a third fast short pitched ball in an over, the umpire, after the call of No ball and when the ball is dead, shall caution the bowler, inform the other umpire, the captain of the fielding side and the batsmen at the wicket of what has occurred. This caution shall apply throughout the innings.
- 41.6.8 If there is a second instance of the bowler being No balled in the innings for bowling more than two fast short pitched deliveries in an over, the umpire shall advise the bowler that this is his final warning for the innings.
- 41.6.9 Should there be any further instance by the same bowler in that innings, the umpire shall:
- call and signal No ball
 - when the ball is dead, direct the captain of the fielding side to suspend the bowler immediately from bowling
 - inform the other umpire for the reason for this action.
- The bowler thus suspended shall not be allowed to bowl again in that innings.
- If applicable, the over shall be completed by another bowler, who shall neither have bowled any part of the previous over, nor be allowed to bowl any part of the next over.
- The umpire shall report the occurrence to the batsmen and, as soon as practicable, to the captain of the batting side.
- The umpires may then report the matter to the ICC Match Referee who shall take such action as is considered appropriate against the bowler concerned.
- 41.6.10 Should the umpires initiate the caution and warning procedures set out in clauses 41.6.1.3, 41.6.9, and 41.7, such cautions and warnings are not to be cumulative.

41.7 Bowling of dangerous and unfair non-pitching deliveries

- 41.7.1 Any delivery, which passes or would have passed, without pitching, above waist height of the striker standing upright at the popping crease, is to be deemed to be unfair, whether or not it is likely to inflict physical injury on the striker. If the bowler bowls such a delivery the umpire shall immediately call and signal No ball.
- If, in the opinion of the umpire, such a delivery is considered likely to inflict physical injury on the batsman by its speed and direction, it shall be considered dangerous. When the ball is dead the umpire shall caution the bowler, indicating that this is a first and final warning. The umpire shall also inform the other umpire, the captain of the fielding side and the batsmen of what has occurred. This caution shall apply to that bowler throughout the innings.

- 41.7.2 Should there be any further instance (where a dangerous non-pitching delivery is bowled and is considered likely to inflict physical injury on the batsman) by the same bowler in that innings, the umpire shall:
- call and signal No ball
 - when the ball is dead, direct the captain of the fielding side to suspend the bowler immediately from bowling
 - inform the other umpire for the reason for this action.
- The bowler thus suspended shall not be allowed to bowl again in that innings.
- If applicable, the over shall be completed by another bowler, who shall neither have bowled any part of the previous over, nor be allowed to bowl any part of the next over.
- Additionally the umpire shall
- report the occurrence to the batsmen and, as soon as practicable, to the captain of the batting side.
- The umpires may then report the matter to the ICC Match Referee who shall take such action as is considered appropriate against the bowler concerned.
- 41.7.3 The warning sequence in clauses 41.7.1 and 41.7.2 is independent of the warning and action sequence in clause 41.6.
- 41.7.4 If the umpire considers that a bowler deliberately bowled a high full-pitched delivery, deemed to be dangerous and unfair as defined in clause 41.7.1, then the caution and warning in clause 41.7.1 shall be dispensed with. The umpire shall
- immediately call and signal No ball.
 - when the ball is dead, direct the captain of the fielding side to suspend the bowler immediately from bowling and inform the other umpire for the reason for this action.
- The bowler thus suspended shall not be allowed to bowl again in that innings.
- If applicable, the over shall be completed by another bowler, who shall neither have bowled any part of the previous over, nor be allowed to bowl any part of the next over.
- report the occurrence to the batsmen and, as soon as practicable, to the captain of the batting side.
- The umpires together shall report the occurrence to the ICC Match Referee who shall take such action as is considered appropriate against the bowler concerned.

41.8 Bowling of deliberate front-foot No ball

If the umpire considers that the bowler has delivered a deliberate front-foot No ball, he/she shall:

- immediately call and signal No ball.
- when the ball is dead, direct the captain of the fielding side to suspend the bowler immediately from bowling
- inform the other umpire for the reason for this action.

The bowler thus suspended shall not be allowed to bowl again in that innings.

If applicable, the over shall be completed by another bowler, who shall neither have bowled any part of the previous over, nor be allowed to bowl any part of the next over.

- report the occurrence to the batsmen and, as soon as practicable, to the captain of the batting side.

The umpires together shall report the occurrence to the ICC Match Referee who shall take such action as is considered appropriate against the bowler concerned.

41.9 Time wasting by the fielding side

41.9.1 It is unfair for any fielder to waste time.

41.9.2 If either umpire considers that the progress of an over is unnecessarily slow, or time is being wasted in any other way, by the captain of the fielding side or by any other fielder, at the first instance the umpire concerned shall:

- if the ball is in play, call and signal Dead ball.
- inform the other umpire of what has occurred.

The bowler's end umpire shall then:

- warn the captain of the fielding side, indicating that this is a first and final warning.
- inform the batsmen of what has occurred.

41.9.3 If either umpire considers that there is any further waste of time in that innings by any fielder, the umpire concerned shall:

- if the ball is in play, call and signal Dead ball.
- inform the other umpire of what has occurred.

The bowler's end umpire shall then award 5 Penalty runs to the batting side and inform the captain of the fielding side of the reason for this action.

Additionally the umpire shall inform the batsmen and, as soon as is practicable, the captain of the batting side of what has occurred.

If the umpires believe that the act of time wasting was deliberate or repetitive, they may lodge a report under the ICC Code of Conduct. In such circumstances the Captain and/or any individual members of the fielding team responsible for the time wasting will be charged.

41.10 Batsman wasting time

41.10.1 It is unfair for a batsman to waste time. In normal circumstances, the striker should always be ready to take strike when the bowler is ready to start his run-up.

In addition, an incoming batsman should be in position to take guard or his partner ready to receive the next ball within 2 minutes of the fall of the previous wicket.

41.10.2 Should either batsman waste time by failing to meet this requirement, or in any other way, the following procedure shall be adopted. At the first instance, either before the bowler starts his run-up or when the ball becomes dead, as appropriate, the umpire shall

- warn both batsmen and indicate that this is a first and final warning. This warning shall apply throughout the innings. The umpire shall so inform each incoming batsman.
- inform the other umpire of what has occurred.
- inform the captain of the fielding side and, as soon as practicable, the captain of the batting side of what has occurred.

41.10.3 If there is any further time wasting by any batsman in that innings, the umpire shall, at the appropriate time while the ball is dead

- award 5 Penalty runs to the fielding side.
- inform the other umpire of the reason for this action.
- inform the other batsman, the captain of the fielding side and, as soon as practicable, the captain of the batting side of what has occurred.

If the umpires believe that the act of time wasting was deemed to be deliberate or repetitive, they may lodge a report under the ICC Code of Conduct. In such circumstances the batsman concerned will be charged.

41.11 The protected area

The protected area is defined as that area of the pitch contained within a rectangle bounded at each end by imaginary lines parallel to the popping creases and 5 ft/1.52 m in front of each, and on the sides by imaginary lines, one each side of the imaginary line joining the centres of the two middle stumps, each parallel to it and 1 ft/30.48 cm from it.

41.12 Fielder damaging the pitch

41.12.1 It is unfair to cause deliberate or avoidable damage to the pitch. A fielder will be deemed to be causing avoidable damage if either umpire considers that his presence on the pitch is without reasonable cause.

- 41.12.2 If a fielder causes avoidable damage to the pitch, other than as in clause 41.13.1, at the first instance the umpire seeing the contravention shall, when the ball is dead, inform the other umpire. The bowler's end umpire shall then
- caution the captain of the fielding side and indicate that this is a first and final warning. This warning shall apply throughout the innings.
 - inform the batsmen of what has occurred.
- 41.12.3 If, in that innings, there is any further instance of avoidable damage to the pitch, by any fielder, the umpire seeing the contravention shall, when the ball is dead, inform the other umpire. The bowler's end umpire shall then
- award 5 Penalty runs to the batting side.
- Additionally the umpire shall
- inform the fielding captain of the reason for this action.
 - inform the batsmen and, as soon as practicable, the captain of the batting side of what has occurred.
- The umpires together shall report the occurrence to the ICC Match Referee who shall take such action as is considered appropriate against the fielder concerned.

41.13 Bowler running on protected area

- 41.13.1 It is unfair for a bowler to enter the protected area in his follow-through without reasonable cause, whether or not the ball is delivered.
- 41.13.2 If a bowler contravenes this clause, at the first instance and when the ball is dead, the umpire shall
- caution the bowler and inform the other umpire of what has occurred. This caution shall apply to that bowler throughout the innings.
 - inform the captain of the fielding side and the batsmen of what has occurred.
- 41.13.3 If, in that innings, the same bowler again contravenes this clause, the umpire shall repeat the above procedure indicating that this is a final warning. This warning shall also apply throughout the innings.
- 41.13.4 If, in that innings, the same bowler contravenes this clause a third time, when the ball is dead, the umpire shall,
- direct the captain of the fielding side to suspend the bowler immediately from bowling. If applicable, the over shall be completed by another bowler, who shall neither have bowled any part of the previous over, nor be allowed to bowl any part of the next over. The bowler taken off shall not be allowed to bowl again in that innings.
 - inform the other umpire of the reason for this action.

- inform the batsmen and, as soon as practicable, the captain of the batting side of what has occurred.

The umpires may then report the matter to the ICC Match Referee who shall take such action as is considered appropriate against the bowler concerned.

41.14 Batsman damaging the pitch

- 41.14.1 It is unfair to cause deliberate or avoidable damage to the pitch. If the striker enters the protected area in playing or playing at the ball, he must move from it immediately thereafter. A batsman will be deemed to be causing avoidable damage if either umpire considers that his presence on the pitch is without reasonable cause.
- 41.14.2 If either batsman causes deliberate or avoidable damage to the pitch, other than as in clause 41.15, at the first instance the umpire seeing the contravention shall, when the ball is dead, inform the other umpire of the occurrence. The bowler's end umpire shall then
- warn both batsmen that the practice is unfair and indicate that this is a first and final warning. This warning shall apply throughout the innings. The umpire shall so inform each incoming batsman.
 - inform the captain of the fielding side and, as soon as practicable, the captain of the batting side of what has occurred.
- 41.14.3 If there is any further instance of avoidable damage to the pitch by any batsman in that innings, the umpire seeing the contravention shall, when the ball is dead, inform the other umpire of the occurrence.
- The bowler's end umpire shall
- disallow all runs to the batting side
 - return any not out batsman to his original end
 - signal No ball or Wide to the scorers if applicable.
 - award 5 Penalty runs to the fielding side.
 - award any other 5-run Penalty that is applicable except for Penalty runs under clause 28.3 (Protective helmets belonging to the fielding side).
 - Inform the captain of the fielding side and, as soon as practicable, the captain of the batting side of the reason for this action.
- The umpires together shall report the occurrence to the ICC Match Referee who shall take such action as is considered appropriate against the batsman concerned.

41.15 Striker in protected area

- 41.15.1 The striker shall not adopt a stance in the protected area or so close to it that frequent encroachment is inevitable.

The striker may mark a guard on the pitch provided that no mark is unreasonably close to the protected area.

- 41.15.2 If either umpire considers that the striker is in breach of any of the conditions in clause 41.15.1, if the bowler has not entered the delivery stride, he/she shall immediately call Dead ball, otherwise, wait until the ball is dead; he/she shall then inform the other umpire of the occurrence.

The bowler's end umpire shall then:

- warn the striker that the practice is unfair and indicate that this is a first and final warning. This warning shall apply throughout the innings. The umpire shall so inform the non-striker and each incoming batsman.
- inform the captain of the fielding side and, as soon as practicable, the captain of the batting side of what has occurred.

- 41.15.3 If there is any further breach of any of the conditions in clause 41.15.1 by any batsman in that innings, the umpire seeing the contravention shall, if the bowler has not entered his delivery stride, immediately call and signal Dead ball, otherwise, he/she shall wait until the ball is dead and then inform the other umpire of the occurrence.

The bowler's end umpire shall

- disallow all runs to the batting side
- return any not out batsman to his original end
- signal No ball or Wide to the scorers if applicable.
- award 5 Penalty runs to the fielding side.
- award any other 5-run Penalty that is applicable except for Penalty runs under clause 28.3 (Protective helmets belonging to the fielding side).
- inform the captain of the fielding side and, as soon as practicable, the captain of the batting side of the reason for this action.

The umpires together shall report the occurrence to the ICC Match Referee who shall take such action as is considered appropriate against the batsman concerned.

41.16 Non-striker leaving his ground early

If the non-striker is out of his ground from the moment the ball comes into play to the instant when the bowler would normally have been expected to release the ball, the bowler is permitted to attempt to run him out. Whether the attempt is successful or not, the ball shall not count as one in the over.

If the bowler fails in an attempt to run out the non-striker, the umpire shall call and signal Dead ball as soon as possible.

41.17 Batsmen stealing a run

- 41.17.1 It is unfair for the batsmen to attempt to steal a run during the bowler's run-up.

Unless the bowler attempts to run out either batsman – see clauses 41.16 and 21.4 (Bowler throwing towards striker's end before delivery) – the umpire shall

- call and signal Dead ball as soon as the batsmen cross in such an attempt.
 - inform the other umpire of the reason for this action.
- The bowler's end umpire shall then
- return the batsmen to their original ends.
 - award 5 Penalty runs to the fielding side.
 - inform the batsmen, the captain of the fielding side and, as soon as practicable, the captain of the batting side, of the reason for this action.

The umpires may then report the matter to the ICC Match Referee who shall take such action as is considered appropriate against the batsman concerned.

41.18 Penalty runs

- 41.18.1 When Penalty runs are awarded to either side, when the ball is dead the umpire shall signal the Penalty runs to the scorers. See clause 2.13 (Signals).

- 41.18.2 Penalty runs shall be awarded in each case where these Playing Conditions require the award, even if a result has already been achieved. See clause 16.6 (Winning hit or extras).

Note, however, that the restrictions on awarding Penalty runs, in clauses 23.3 (Leg byes not to be awarded), 34.4 (Runs scored from ball lawfully struck more than once) and 28.3 (Protective helmets belonging to the fielding side), will apply.

- 41.18.3 When 5 Penalty runs are awarded to the batting side under any of clauses 24.4 (Player returning without permission), 28.2 (Fielding the ball), 28.3 (Protective helmets belonging to the fielding side) or under 41.3, 41.4, 41.5, 41.9 or 41.12, then
- they shall be scored as Penalty extras and shall be in addition to any other penalties.
 - they are awarded when the ball is dead and shall not be regarded as runs scored from either the immediately preceding delivery or the immediately following delivery, and shall be in addition to any runs from those deliveries.
 - the batsmen shall not change ends solely by reason of the 5 run penalty.

- 41.18.4 When 5 Penalty runs are awarded to the fielding side, under clause 18.5.2 (Deliberate short runs), or under 41.10, 41.14, 41.15 or 41.17, they shall be added as Penalty extras to that side's total of runs in its most recently completed innings. If the fielding side has not completed an innings, the 5 Penalty runs shall be added to the score in its next innings.

42 PLAYERS' CONDUCT**42.1 Serious misconduct**

- 42.1.1 The umpires shall act upon any serious misconduct. The relevant offences and the corresponding actions by the umpires are identified in clause 42.2.1. These offences correspond with Level 4 offences in the ICC Code of Conduct. Level 1 to Level 3 offences continue to be dealt with separately under the ICC Code of Conduct.
- 42.1.2 If either umpire considers that a player has committed one of these offences at any time during the match, the umpire concerned shall call and signal Dead ball. This call may be delayed until the umpire is satisfied that it will not disadvantage the non-offending side.
- 42.1.3 The umpire concerned shall report the matter to the other umpire and together they shall decide whether an offence has been committed. The umpires may also consult with the third umpire and the match referee, who may review any audio or video replays to confirm whether an offence has been committed. If so, the umpires shall then apply the related sanctions.
- 42.1.4 If the offence is committed by a batsman, the umpires shall summon the offending player's captain to the field. Solely for the purpose of this clause, the batsmen at the wicket may not deputise for their captain.

42.2 Level 4 offences and action by umpires

- 42.2.1 Any of the following actions by a player shall constitute a Level 4 offence:
- threatening to assault an umpire
 - making inappropriate and deliberate physical contact with an umpire
 - physically assaulting a player or any other person
 - committing any other act of violence.
- 42.2.2 If such an offence is committed, 42.2.2.1 to 42.2.2.5 shall be implemented.
- 42.2.2.1 The umpire shall call Time.
- 42.2.2.2 Together the umpires shall summon and inform the offending player's captain that an offence at this Level has occurred.
- 42.2.2.3 The umpires shall instruct the captain to remove the offending player immediately from the field of play for the remainder of the match and shall apply the following:
- 42.2.2.3.1 If the offending player is a fielder, no substitute shall be allowed for him. He is to be recorded as Retired – out at the commencement of any subsequent innings in which his team is the batting side.

- 42.2.2.3.2 If a bowler is suspended mid-over, then that over must be completed by a different bowler, who shall not have bowled the previous over nor shall be permitted to bowl the next over.
- 42.2.2.3.3 If the offending player is a batsman he is to be recorded as Retired – out in the current innings, unless he has been dismissed under any of clauses 32 to 39, and at the commencement of any subsequent innings in which his team is the batting side. If no further batsman is available to bat, the innings is completed.
- 42.2.2.4 As soon as practicable, the umpire shall:
- award 5 Penalty runs to the opposing team
 - signal the Level 4 penalty to the scorers
 - call Play.
- 42.2.2.5 The umpires shall then report the matter to the ICC Match Referee under the ICC Code of Conduct.

42.3 Captain refusing to remove a player from the field

- 42.3.1 If a captain refuses to carry out an instruction under 42.2.2.3, the umpires shall invoke clause 16.3 (Umpires awarding a match).
- 42.3.2 If both captains refuse to carry out instructions under 42.2.2.3 in respect of the same incident, the umpires shall instruct the players to leave the field. The match is not concluded as in clause 12.9 and there shall be no result under clause 16.

42.4 Additional points relating to Level 4 offences

- 42.4.1 If a player, while acting as wicket-keeper, commits a Level 4 offence, clause 24.1.2 shall not apply, meaning that only a nominated player may keep wicket, even if another fielder becomes injured or ill and is replaced by a substitute.
- 42.4.2 A nominated player who has a substitute will also suffer the penalty for any Level 4 offence committed by the substitute. However, only the substitute will be reported under clause 42.2.2.5.

APPENDICES TO ICC WORLD TEST CHAMPIONSHIP PLAYING CONDITIONS

(INCORPORATING THE 2017 CODE OF THE MCC LAWS OF CRICKET)
EFFECTIVE 1 OCTOBER 2017

A. Definitions

B. Equipment

1. The bat
2. The wickets
3. Wicket-keeping gloves

C. The venue

1. The pitch and the creases
2. Advertising on grounds, perimeter boards and sight-screens
3. Markings on outfield

D. Decision Review System (DRS) and Third Umpire Protocol

E. Calculations

APPENDIX A

DEFINITIONS

1 THE MATCH

- 1.1 **The game** is used in these Playing Conditions as a general term meaning the Game of Cricket.
- 1.2 **A match** is a single Test Match between two teams, played under these Playing Conditions.
- 1.3 **The toss** is the toss for choice of innings.
- 1.4 **Before the toss** is at any time before the toss on the day the match is expected to start.
- 1.5 **Before the match** is at any time before the toss, not restricted to the day on which the toss is to take place.
- 1.6 **During the match** is at any time after the toss until the conclusion of the match, whether play is in progress or not.
- 1.7 **Playing time** is any time between the call of Play and the call of Time. See clauses 12.1 (Call of Play) and 12.2 (Call of Time).
- 1.8 **Conduct of the match** includes any action relevant to the match at any time on any day of the match.
- 1.9 **Ground Authority** is the entity responsible for the selection and preparation of the pitch and other functions relating to the hosting and management of the match, including any agents acting on their behalf (including but not limited to the curator or other ground staff).
- 1.10 **Home Board** is the ICC member responsible for the home team and the hosting of the match.
- 1.11 **Visiting Board** is the ICC member responsible for the visiting team.
- 1.12 **The Spirit of Cricket** refers to the values of respect and fair play that underpin the game of cricket, as set out in the Preamble to these Playing Conditions.
- 1.13 **The ICC Code of Conduct** is the ICC Code of Conduct for Players and Player Support Personnel, as amended from time to time.
- 1.14 **The Competition Window** means, in relation to the 2019-2021 edition of the ICC World Test Championship, the period from Thursday 1 August 2019 until Wednesday 31 March 2021 (inclusive);
- 1.15 **The Round Stage** is the twenty-seven (27) series comprising the 2019-2021 edition of the ICC World Test Championship.
- 1.16 **A Penalty Over** has the meaning set out in clause 16.11 and shall be calculated in accordance with the process set out in clause 12.9.

2 IMPLEMENTS AND EQUIPMENT

- 2.1 **Implements used in the match** are the bat, the ball, the stumps and bails.
- 2.2 **External protective equipment** is any visible item of apparel worn for protection against external blows.
- For a batsman, items permitted are a protective helmet, external leg guards (batting pads), batting gloves and, if visible, forearm guards.
- For a fielder, only a protective helmet is permitted, except in the case of a wicket-keeper, for whom wicket-keeping pads and gloves are also permitted.
- 2.3 **A protective helmet** is headwear made of hard material and designed to protect the head or the face or both, which shall (in line with the Clothing and Equipment Regulations) be certified to BS7928:2013. For the purposes of interpreting these Playing Conditions, such a description will include faceguards.
- 2.4 **Equipment** – a batsman's equipment is his bat as defined above, together with any external protective equipment he is wearing.
- A fielder's equipment** is any external protective equipment that he is wearing.
- 2.5 **The bat** – the following are to be considered as part of the bat:
- the whole of the bat itself.
 - the whole of a glove (or gloves) worn on the hand (or hands) holding the bat.
 - the hand (or hands) holding the bat, if the batsman is not wearing a glove on that hand or on those hands.
- 2.6 Held in batsman's hand. Contact between a batsman's hand, or glove worn on his hand, and any part of the bat shall constitute the bat being held in that hand.

3 THE PLAYING AREA

- 3.1 **The field of play** is the area contained within the boundary.
- 3.2 **The square** is a specially prepared area of the field of play within which the match pitch is situated.
- 3.3 **The outfield** is that part of the field of play between the square and the boundary.

4 POSITIONING

- 4.1 **Behind the popping crease** at one end of the pitch is that area of the field of play, including any other marking, objects and persons therein, that is on that side of the popping crease that does not include the creases at the opposite end of the pitch. **Behind**, in relation to any other marking, object or person, follows the same principle. See the diagram in paragraph 13.

- 4.2 **In front of the popping crease** at one end of the pitch is that area of the field of play, including any other marking, objects and persons therein, that is on that side of the popping crease that includes the creases at the opposite end of the pitch. In front of, in relation to any other marking, object or person, follows the same principle. See the diagram in paragraph 13.
- 4.3 **The striker's end** is the place where the striker stands to receive a delivery from the bowler only insofar as it identifies, independently of where the striker may subsequently move, one end of the pitch.
- 4.4 **The bowler's end** is the end from which the bowler delivers the ball. It is the other end of the pitch from the striker's end and identifies that end of the pitch that is not the striker's end as described in paragraph 4.3.
- 4.5 **The wicket-keeper's end** is the same as the striker's end as described in paragraph 4.3.
- 4.6 **In front of the line of the striker's wicket** is in the area of the field of play in front of the imaginary line joining the fronts of the stumps at the striker's end; this line to be considered extended in both directions to the boundary. See paragraph 4.2.
- 4.7 **Behind the wicket** is in the area of the field of play behind the imaginary line joining the backs of the stumps at the appropriate end; this line to be considered extended in both directions to the boundary. See paragraph 4.1.
- 4.8 **Behind the wicket-keeper** is behind the wicket at the striker's end, as defined above, but in line with both sets of stumps and further from the stumps than the wicket-keeper.
- 4.9 **Off side/on (leg) side** – see diagram in paragraph 13
- 4.10 **Inside edge** is the edge on the same side as the nearer wicket.

5 UMPIRES AND DECISION-MAKING

- 5.1 **Umpire** – where the description **the umpire** is used on its own, it always means 'the bowler's end umpire' though this full description is sometimes used for emphasis or clarity. Similarly the umpires always means both umpires and the third umpire. **An umpire** and **umpires** are generalised terms. Otherwise, a fuller description indicates which one of the umpires is specifically intended. Each umpire will be bowler's end umpire and striker's end umpire in alternate overs.
- 5.2 **Bowler's end umpire** is the umpire who is standing at the bowler's end (see paragraph 4.4) for the current delivery.
- 5.3 **Striker's end umpire** is the umpire who is standing at the striker's end (see paragraph 4.3), to one side of the pitch or the other, depending on his/her choice, for the current delivery.
- 5.4 **On-field umpires** shall mean, collectively, the bowler's end umpire and the striker's end umpire.
- 5.5 **Third umpire** is the umpire who may use television evidence and other available technology in order review a decision of the on-field umpires, either by way of an Umpire Review or a Player Review under the protocol set out in Appendix D.

- 5.6 **Umpires together agree** applies to decisions which the umpires are to make jointly, independently of the players.
- 5.7 **Decision Review System** or **DRS** is the process covered by the Decision Review System and Third Umpire Protocol set out in Appendix D, under which the third umpire may be consulted in relation to a decision of the on-field umpires, either by way of an Umpire Review or a Player Review.
- 5.8 **Player Review** is the process set out in Appendix D by which a player may request a review of any decision taken by the on-field umpires concerning whether or not a batsman is dismissed (with the exception of 'Timed out').
- 5.9 **Umpire Review** is the process set out in Appendix D by which an on-field umpire has the discretion to refer a decision to the third umpire or, under certain circumstances, to consult with the third umpire before making a decision.
- 5.10 **Soft Signal** is the visual communication by the bowler's end umpire to the third umpire (accompanied by additional information via two-way radio where necessary) of his/her initial on-field decision prior to initiating an Umpire Review.
- 5.11 **Umpire's Call** is the concept within the DRS under which the on-field decision of the bowler's end umpire shall stand, which shall apply under the specific circumstances set out in paragraphs 3.4.5 and 3.4.6 of Appendix D, where the ball-tracking technology indicates a marginal decision in respect of either the Impact Zone or the Wicket Zone.
- 5.12 **The Pitching Zone** as used in the DRS is a two dimensional area on the pitch between both sets of stumps with its boundaries consisting of the base of both sets of stumps and a line between the outside of the outer stumps at each end.
- 5.13 The **Impact Zone** as used in the DRS is a three dimensional space extending between both sets of stumps to an indefinite height vertically and with its boundaries consisting of the base of the stumps and the outside of the outer stumps at each end.
- 5.14 The **Wicket Zone** as used in the DRS is a two dimensional area with its boundaries consisting of the outside of the outer stumps, the base of the stumps, and the lower edge of the bails.
- 5.15 A **Fair Catch** is a catch that has been taken cleanly by the fielder in accordance with clause 33.
- 5.16 A **Bump Ball** is where the ball has made contact with the ground shortly after making contact with the striker's bat.
- 5.17 The **Elite Panel** is the group of umpires contracted to the ICC to officiate in international cricket.
- 5.18 The **International Panel** is the group of umpires nominated by the ICC's full members in accordance with clause **Error! Reference source not found.** of the Playing Conditions.

6 BATSMEN

- 6.1 **Batting side** is the side currently batting, whether or not play is in progress.
- 6.2 **Member of the batting side** is one of the players nominated by the captain of the batting side, or any authorised replacement for such nominated player.
- 6.3 **A batsman's ground** – at each end of the pitch, the whole area of the field of play behind the popping crease is the ground at that end for a batsman.
- 6.4 **Original end** is the end where a batsman was when the ball came into play for that delivery.
- 6.5 **Wicket he has left** is the wicket at the end where a batsman was at the start of the run in progress.
- 6.6 **Guard position** is the position and posture adopted by the striker to receive a ball delivered by the bowler.
- 6.7 For the purposes of these Playing Conditions, **waist height** is defined as the point at which the top of the batsman's trousers would conventionally be when he is standing upright at the popping crease.

7 FIELDERS

- 7.1 **Fielding side** is the side currently fielding, whether or not play is in progress.
- 7.2 **Member of the fielding side** is one of the players nominated by the captain of the fielding side, or any authorised replacement or substitute for such nominated player.
- 7.3 **Fielder** is one of the 11 or fewer players who together represent the fielding side on the field of play. This definition includes not only both the bowler and the wicket-keeper but also nominated players who are legitimately on the field of play, together with players legitimately acting as substitutes for absent nominated players. It excludes any nominated player who is absent from the field of play, or who has been absent from the field of play and who has not yet obtained the umpire's permission to return.

A player going briefly outside the boundary in the course of discharging his duties as a fielder is not absent from the field of play nor, for the purposes of clause 24.2 (Fielder absent or leaving the field of play), is he to be regarded as having left the field of play.

8 SUBSTITUTES AND CONCUSSION REPLACEMENTS

- 8.1 A **Substitute** is a player who takes the place of a fielder on the field of play, but does not replace the player for whom he substitutes on that side's list of nominated players. A substitute's activities are limited to fielding.
- 8.2 A **Concussion Replacement** is a player who takes the place of a player who has been replaced in accordance with the process set out in clause 12.7, and who for the remainder of the match replaces that player on that side's list of nominated players, being able to take a full part in the match (subject to such restrictions as may be imposed by the ICC Match Referee in accordance with clause 12.8

- 8.3 A **Concussion Replacement Request** is the notification made to the ICC Match Referee in accordance with the process set out in clause 1.2.7.3
- 8.4 The **Team Medical Representative** is the individual designated as having responsibility for the assessment of any head or neck injury sustained by a player as set out in clause 1.2.7.2

9 BOWLERS

- 9.1 **Over the wicket / round the wicket** – If, as the bowler runs up between the wicket and the return crease, the wicket is on the same side as his bowling arm, he is bowling over the wicket. If the return crease is on the same side as his bowling arm, he is bowling round the wicket.
- 9.2 **Delivery swing** is the motion of the bowler's arm during which he normally releases the ball for a delivery.
- 9.3 **Delivery stride** is the stride during which the delivery swing is made, whether the ball is released or not. It starts when the bowler's back foot lands for that stride and ends when the front foot lands in the same stride. The stride after the delivery stride is completed when the next foot lands, i.e. when the back foot of the delivery stride lands again.
- 9.4 The **Illegal Bowling Regulations** are the ICC's regulations governing Illegal Bowling Actions.
- 9.5 An **Illegal Bowling Action** is a bowling action where a bowler's Elbow Extension exceeds 15 degrees, measured from the point at which the bowling arm reaches the horizontal until the point at which the ball is released (any Elbow Hyperextension shall be discounted for the purposes of determining an Illegal Bowling Action).
- 9.6 **Elbow Extension** means the motion that occurs when a bowler's arm moves from a flexed (bent) position at the elbow, to a more extended (straight) position (full Elbow Extension occurs when the arm is straight).
- 9.7 **Elbow Hyperextension** is the motion that occurs when a bowler's elbow extends beyond the straight position.
- 9.8 The **ICC Bowling Action Report Form** is the form provided for by Article 3 of the Illegal Bowling Regulations, by which an umpire and/or the ICC Match Referee may submit a report relating to a suspected Illegal Bowling Action.

10 THE BALL

- 10.1 **The ball is struck/strikes the ball** unless specifically defined otherwise, mean 'the ball is struck by the bat'/'strikes the ball with the bat'.
- 10.2 **Rebounds directly/strikes directly** and similar phrases mean 'without contact with any fielder' but do not exclude contact with the ground.
- 10.3 **Full-pitch** describes a ball delivered by the bowler that reaches or passes the striker without having touched the ground. Sometimes described as non-pitching.

11 RUNS

- 11.1 **A run to be disallowed** is one that in these Playing Conditions should not have been taken. It is not only to be cancelled but the batsmen are to be returned to their original ends.
- 11.2 **A run not to be scored** is one that is not illegal, but is not recognised as a properly executed run. It is not a run that has been made, so the question of cancellation does not arise. The loss of the run so attempted is not a disallowance and the batsmen will not be returned to their original ends on that account.

12 THE PERSON

- 12.1 **Person**; A player's person is his physical person (flesh and blood) together with any clothing or legitimate external protective equipment that he is wearing except, in the case of a batsman, his bat.
- A hand, whether gloved or not, that is not holding the bat is part of the batsman's person.
- No item of clothing or equipment is part of the player's person unless it is attached to him.
- For a batsman, a glove being held but not worn is part of his person.
- For a fielder, an item of clothing or equipment he is holding in his hand or hands is not part of his person.
- 12.2 **Clothing** – anything that a player is wearing, including such items as spectacles or jewellery, that is not classed as external protective equipment is classed as clothing, even though he may be wearing some items of apparel, which are not visible, for protection. A bat being carried by a batsman does not come within this definition of clothing.
- 12.3 **Hand** for batsman or wicket-keeper shall include both the hand itself and the whole of a glove worn on the hand.

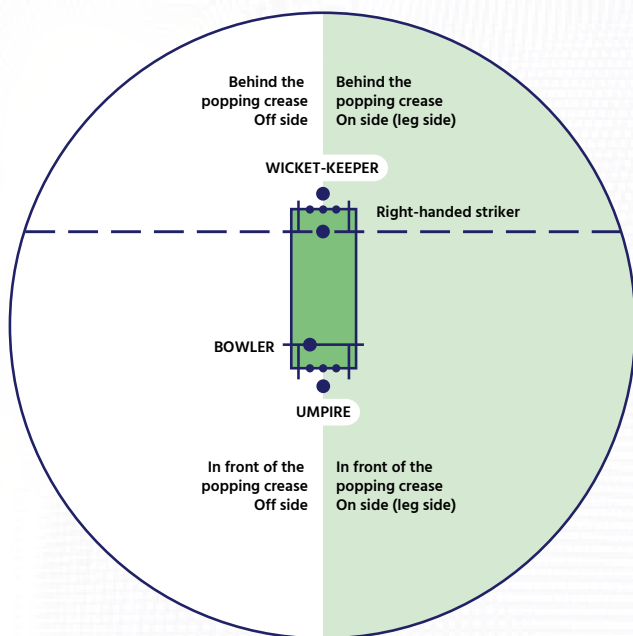
13 OFF SIDE / ON SIDE; IN FRONT OF /
BEHIND THE POPPING CREASE.

APPENDIX B

EQUIPMENT

1 THE BAT

1.1 General guidance

- 1.1.1 **Measurements** - All provisions in paragraphs 1.2 to 1.6 below are subject to the measurements and restrictions stated in the Playing Conditions and this Appendix.
- 1.1.2 **Adhesives** - Throughout, adhesives are permitted only where essential and only in minimal quantity.

1.2 Specifications for the Handle

- 1.2.1 One end of the handle is inserted into a recess in the blade as a means of joining the handle and the blade.
- This lower portion is used purely for joining the blade and the handle together. It is not part of the blade but, solely in interpreting paragraphs 1.3 and 1.4 below, references to the blade shall be considered to extend also to this lower portion of the handle where relevant.
- 1.2.2 The handle may be glued where necessary and bound with twine along the upper portion.
- Providing clause 5.5 is not contravened, the upper portion may be covered with materials solely to provide a surface suitable for gripping. Such covering is an addition and is not part of the bat, except in relation to clause 5.6. The bottom of this grip should not extend below the point defined in paragraph 1.2.4 below.
- Twine binding and the covering grip may extend beyond the junction of the upper and lower portions of the handle, to cover part of the shoulders of the bat as defined in paragraph 1.3.1.
- No material may be placed on or inserted into the lower portion of the handle other than as permitted above together with the minimal adhesives or adhesive tape used solely for fixing these items, or for fixing the handle to the blade.
- 1.2.3 **Materials in handle** - As a proportion of the total volume of the handle, materials other than cane, wood or twine are restricted to one-tenth. Such materials must not project more than 3.25 in/8.26 cm into the lower portion of the handle
- 1.2.4 **Binding and covering of handle** - The permitted continuation beyond the junction of the upper and lower portions of the handle is restricted to a maximum, measured along the length of the handle, of
- 2.5 in/6.35 cm in for the twine binding
 - 2.75 in/6.99 cm for the covering grip.

1.3 Specifications for the Blade

- 1.3.1 The blade has a face, a back, a toe, sides and shoulders
- 1.3.1.1 The face of the blade is its main striking surface and shall be flat or have a slight convex curve resulting from traditional pressing techniques. The back is the opposite surface.
- 1.3.1.2 The shoulders, sides and toe are the remaining surfaces, separating the face and the back.
- 1.3.1.3 The shoulders, one on each side of the handle, are along that portion of the blade between the first entry point of the handle and the point at which the blade first reaches its full width.
- 1.3.1.4 The toe is the surface opposite to the shoulders taken as a pair.
- 1.3.1.5 The sides, one each side of the blade, are along the rest of the blade, between the toe and the shoulders.
- 1.3.2 No material may be placed on or inserted into the blade other than as permitted in paragraph 1.2.4, paragraph 1.3.3, and clause 5.4 together with the minimal adhesives or adhesive tape used solely for fixing these items, or for fixing the handle to the blade.
- 1.3.3 **Covering the blade.** Bats shall have no covering on the blade except as permitted in clause 5.4.
- Any materials referred to above, in clause 5.4 and paragraph 1.4 below, are to be considered as part of the bat, which must still pass through the gauge as defined in paragraph 1.6.

1.4 Protection and repair

- 1.4.1 The surface of the blade may be treated with non-solid materials to improve resistance to moisture penetration and/or mask natural blemishes in the appearance of the wood. Save for the purpose of giving a homogeneous appearance by masking natural blemishes, such treatment shall not materially alter the colour of the blade.
- 1.4.2 Materials can be used for protection and repair as stated in clause 5.4 and are additional to the blade. Note however clause 5.6.
- Any such material shall not extend over any part of the back of the blade except in the case of clause 5.4.1 and then only when it is applied as a continuous wrapping covering the damaged area.
- The repair material shall not extend along the length of the blade more than 0.79 in/2.0 cm in each direction beyond the limits of the damaged area. Where used as a continuous binding, any overlapping shall not breach the maximum of 0.04 in/0.1 cm in total thickness.
- The use of non-solid material which when dry forms a hard layer more than 0.004 in/0.01 cm in thickness is not permitted.

- 1.4.3 Permitted coverings, repair material and toe guards, not exceeding their specified thicknesses, may be additional to the dimensions above, but the bat must still pass through the gauge as described in paragraph 1.6.

1.5 Commercial identifications

Such identifications shall comply with the restrictions set out in the Clothing and Equipment Regulations in relation to the size and position of marks and logos.

1.6 Bat Gauge

All bats must meet the specifications defined in clause 5.7. They must also, with or without protective coverings permitted in clause 5.4, be able to pass through a bat gauge, the dimensions and shape of which are shown in the following diagram:

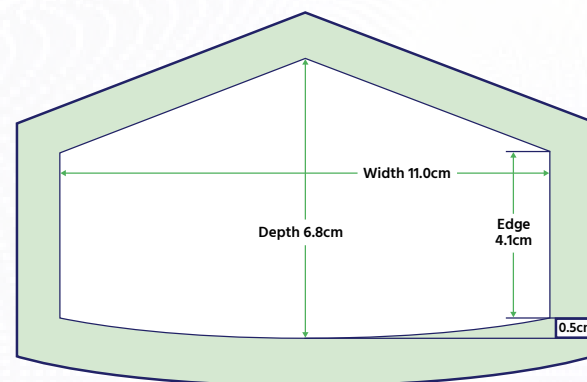
**DIMENSIONS OF APERTURE**

Total Depth: 2.68 in/6.8 cm

Width: 4.33 in/11.0 cm

Edge: 1.61 in/4.1 cm

Curve: 0.20 in/0.5 cm

Note: The curve of the lower edge of the aperture is an arc of a circle of radius 12.0 in/30.5 cm, whose centre is on the vertical centre line of the aperture.

2 THE WICKETS**2.1 Bails**

Overall 4.31 in / 10.95 cm

a = 1.38 in / 3.50 cm

b = 2.13 in / 5.40 cm

c = 0.81 in / 2.06 cm

2.2 Stumps

Height (d) = 28 in / 71.1 cm

Diameter (e) - maximum = 1.5 in / 3.81 cm; minimum = 1.38 in / 3.50 cm

2.3 Overall

Width (f) of wicket 9 in / 22.86 cm

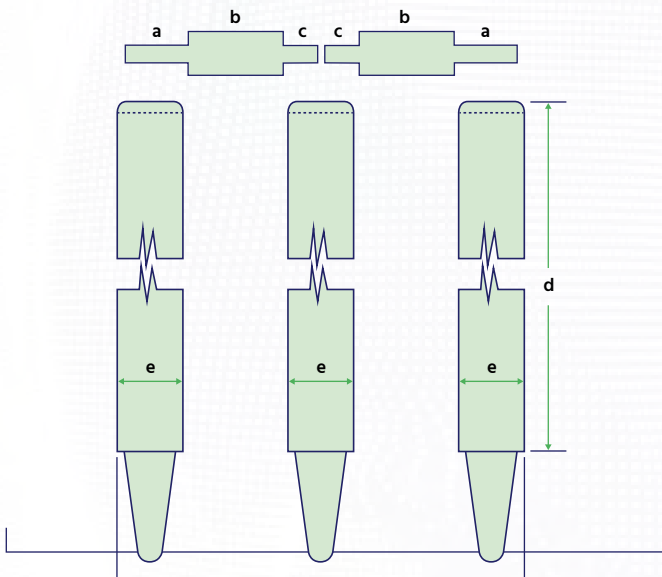
**3 WICKET-KEEPING GLOVES**

- 3.1 The images below illustrate the requirements of clause 27.2 in relation to:
- no webbing between the fingers;
 - a single piece of non-stretch material between finger and thumb as a means of support; and
 - when a hand wearing the glove has the thumb fully extended, the top edge being taut and not protruding beyond the straight line joining the top of the index finger to the top of the thumb.
- 3.2 Note also the requirement for wicket-keeping gloves to comply with the Clothing and Equipment Regulations in relation to the size and position of marks and logos.



APPENDIX C

THE VENUE

1 THE PITCH AND THE CREASES

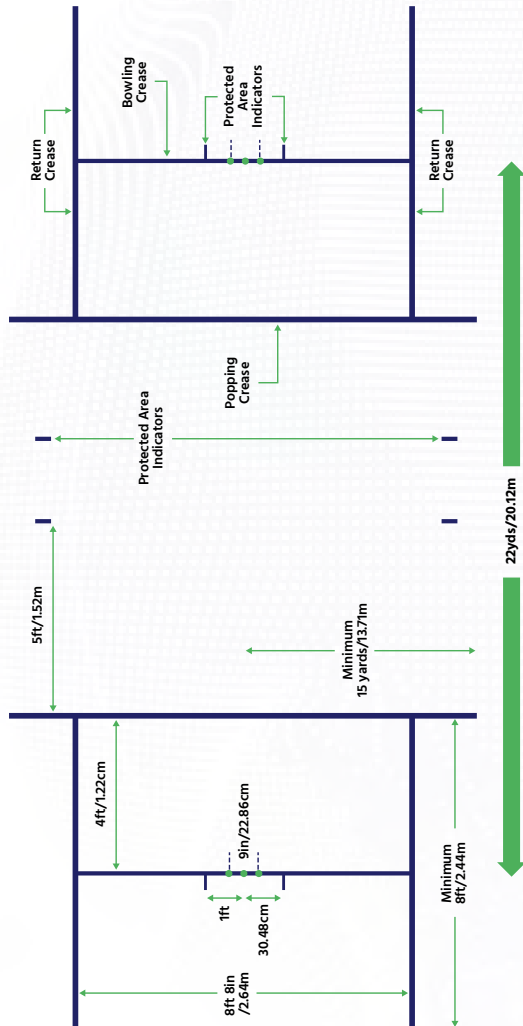

2 ADVERTISING ON GROUNDS, PERIMETER BOARDS AND SIGHT-SCREENS

2.1 Advertising on grounds

- 2.1.1 The logos on outfield are to be positioned as follows:
- Behind the stumps – a minimum of 25.15 yards (23 meters) from the stumps.
 - Midwicket/cover area – no advertising to be positioned within 30 yards (27.50 meters) of the centre of the pitch being used for the match.
- 2.1.2 Note: Advertising closer to the stumps as set out above which is required to meet 3D requirements for broadcasters may be permitted, subject to prior ICC approval having been obtained.

2.2 Perimeter boards

- 2.2.1 Advertising on perimeter boards placed in front of the sight-screens is permitted save that the predominant colour of such advertising shall be of a contrasting colour to that of the ball.
- 2.2.2 Advertising on perimeter boards behind the stumps at both ends shall not contain moving, flashing or flickering images and operators should ensure that the images are only changed or moved at a time that will not be distracting to the players or the umpires.
- 2.2.3 The brightness of any electronic images shall be set at a level so that it is not a distraction to the players or umpires.

2.3 Sight-screens

- 2.3.1 Sight-screens shall be provided at both ends of all grounds. For day-night Test matches, they will be white or black as determined by the Home Board.
- 2.3.2 Advertising shall be permitted on the sight-screen behind the striker, providing it is removed for the subsequent over from that end.
- 2.3.3 Such advertising shall not contain flashing or flickering images and particular care should be taken by the operators that the advertising is not changed at a time which is distracting to the umpire.

3 MARKINGS ON OUTFIELD

With the permission of the Ground Authority, a bowler may use paint to make a small marking on the outfield for the purposes of identifying their run-up. Paint used for this purpose shall be any colour other than white.

APPENDIX D

DECISION REVIEW SYSTEM (DRS)

1 GENERAL

- 1.1 It is mandatory for the Host Board to provide DRS technology for all World Test Championship matches.
- 1.2 Minimum requirements for use of DRS.
 - 1.2.1 The camera specification set out below shall be mandatory as a minimum requirement.

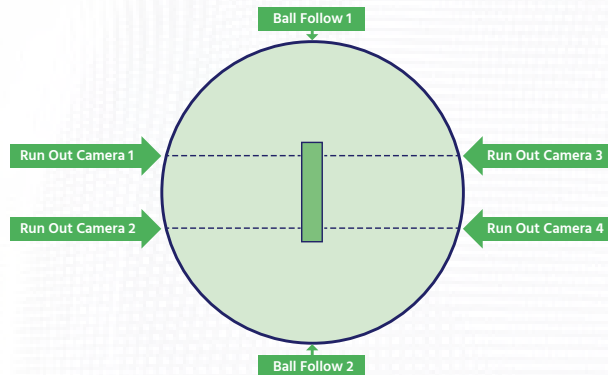

- 1.2.2 The table below summarises the minimum requirements for DRS to be used, and the regulations around the appointment of the third umpire:

DRS	
Minimum Requirement	Cameras – Specification detailed in paragraph 12.1. Technology – Approved ball-tracking technology. – Approved sound-based edge detection technology.
Third Umpire Jurisdiction	Umpire Reviews and Player Reviews
Replays that can be used	Any replay, stump microphone audio or technology detailed in paragraph 3.8.1 below.
ICC Technical Officer	The ICC shall appoint an independent technology expert (ICC Technical Officer) to be present at every series to assist the third umpire and to protect the integrity of the DRS process.

- 1.2.3 The Home Board shall ensure that a separate room is provided for the third umpire and that he/she has access to the television equipment and technology so as to be in the best position to facilitate the referral and/or consultation processes referred to in paragraphs 2 (Umpire Review) and 3 (Player Review) below.

2 UMPIRE REVIEW

In the circumstances detailed in paragraphs 2.1, 2.2, 2.3 and 2.4 below, the on-field umpire shall have the discretion to refer the decision to the third umpire or, in the case of paragraphs 2.2, and 2.4, to consult with the third umpire before making the decision.

Save for requesting the umpire to review his/her decision under paragraph 3 (Player Review) below, players may not appeal to the on-field umpires to use the Umpire Review. Breach of this provision may constitute dissent and the player may be subject to disciplinary action under the ICC Code of Conduct for Players and Player Support Personnel.

2.1 Run Out, Stumped, Bowled and Hit Wicket Decisions

- 2.1.1 The relevant on-field umpire shall be entitled to refer an appeal for run-out, stumped, bowled or hit wicket to the third umpire.
- 2.1.2 An on-field umpire wishing to refer a decision to the third umpire shall signal to the third umpire by making the shape of a TV screen with his/her hands.
- 2.1.3 In the case of a referral of a bowled, hit wicket or stumped decision, the third umpire shall first check the fairness of the delivery (all modes of No ball except for the bowler using an Illegal Bowling Action, subject to the proviso that the third umpire may review whether the bowler has used a prohibited Specific Variation under Article 6.2 of the Illegal Bowling Regulations). If the delivery was not a fair delivery the third umpire shall indicate that the batsman is Not out and advise the on-field umpire to signal No ball. See also paragraph 2.5 below.

- 2.14 Additionally, if the third umpire finds the batsman is Out by another mode of dismissal (excluding LBW), or Not out by any mode of dismissal (excluding LBW), he/she shall notify the on-field umpire so that the correct decision is made.
- 2.15 If the third umpire decides that the batsman is Out, a red light shall be displayed; if the third umpire decides that the batsman is Not out, a green light shall be displayed. Should the third umpire be temporarily unable to respond, a white light (where available) shall remain illuminated throughout the period of interruption to signify to the on-field umpires that Umpire Reviews are temporarily unavailable, in which case the decision shall be taken by the on-field umpire. As an alternative to the red/green light system, the replay screen (where available) may be used for the purpose of conveying the third umpire's decision, in line with the ICC Big Screen Policy.

2.2 Caught Decisions, Obstructing the Field

- 2.2.1 Where the bowler's end umpire is unable to decide upon a Fair Catch or a Bump Ball, or if, on appeal from the fielding side, the batsman obstructed the field, he/she shall first consult with the striker's end umpire.
- 2.2.2 Should both on-field umpires require assistance from the third umpire to make a decision, the bowler's end umpire shall firstly take a decision on-field after consulting with the striker's end umpire, before consulting by two-way radio with the third umpire. Such consultation shall be initiated by the bowler's end umpire to the third umpire by making the shape of a TV screen with his/her hands, followed by a Soft Signal of Out or Not out made with the hands close to the chest at chest height. If the third umpire advises that the replay evidence is inconclusive, the on-field decision communicated at the start of the consultation process shall stand.
- 2.2.3 The third umpire shall determine whether the batsman has been caught, whether the delivery was a Bump Ball, or if the batsman obstructed the field. However, in reviewing the television replay(s), the third umpire shall first check the fairness of the delivery for all decisions involving a catch (all modes of No ball except for the bowler using an Illegal Bowling Action, subject to the proviso that the third umpire may review whether the bowler has used a prohibited Specific Variation under Article 6.2 of the Illegal Bowling Regulations) and whether the batsman has hit the ball. If the delivery was not a fair delivery or if it is clear to the third umpire that the batsman did not hit the ball he/she shall indicate to the bowler's end umpire that the batsman is Not out caught, and in the case of an unfair delivery, advise the bowler's end umpire to signal No ball. See also paragraph 2.5 below. Additionally, if it is clear to the third umpire that the batsman is Out by another mode of dismissal (excluding LBW), or Not out by any mode of dismissal (excluding LBW), he/she shall notify the bowler's end umpire so that the correct decision can be made.
- 2.2.4 The third umpire shall communicate his/her decision as set out in paragraph 2.15.

2.3 Boundary Decisions

- 2.3.1 The bowler's end umpire shall be entitled to refer to the third umpire for a decision on:
- 2.3.1.1 whether a four or six has been scored;
- 2.3.1.2 whether a fielder had any part of his person in contact with the ball when he touched the boundary; or
- 2.3.1.3 whether the fielder had any part of his person in contact with the ball when he had any part of his person grounded beyond the boundary.
- 2.3.2 A decision shall be made immediately and cannot be changed thereafter.
- 2.3.3 If the television evidence is inconclusive as to whether or not a boundary has been scored, the default presumption shall be in favour of no boundary being awarded.
- 2.3.4 Where the bowler's end umpire wishes to use the assistance of the third umpire in this circumstance, he/she shall communicate with the third umpire by use of a two-way radio and the third umpire shall convey his/her decision to the bowler's end umpire by the same method.
- 2.3.5 The third umpire may initiate contact with the on-field umpire by two-way radio if TV coverage shows a boundary line infringement or incident that appears not to have been acted upon by the on-field umpires.

2.4 Batsmen Running to the Same End

- 2.4.1 Where both batsmen have run to the same end and the on-field umpires are uncertain over which batsman made his ground first, the on-field umpires may consult with the third umpire.
- 2.4.2 The procedure set out in paragraph 2.3.4 shall apply.

2.5 No Balls

- 2.5.1 If the bowler's end umpire is uncertain as to the fairness of the delivery following a dismissal, either affecting the validity of the dismissal or which batsman is dismissed, he/she shall be entitled to request the batsman to delay leaving the field and to check the fairness of the delivery with the third umpire. Communication with the third umpire shall be by two-way radio.
- 2.5.2 The third umpire shall check all modes of No ball except for the bowler using an Illegal Bowling Action (subject to the proviso that the third umpire may review whether the bowler has used a prohibited Specific Variation under Article 6.2 of the Illegal Bowling Regulations). The third umpire shall apply clause 21.5 when deciding whether a No ball should have been called (and must therefore be satisfied that none of the three conditions in clause 21.5 have been met before calling a No ball).

- 2.5.3 If the delivery was not a fair delivery, the bowler's end umpire shall indicate that the batsman is Not out and signal No ball (except in the case of a dismissal for obstructing the field, which may still be effected despite a No ball being called, in which case the bowler's end umpire shall indicate that the relevant batsman is Out and additionally call a No ball).
- 2.5.4 If a No ball is called following the check by the third umpire, the batting side shall benefit from the reversal of the dismissal and the one run for the No ball, but shall not benefit from any runs that may subsequently have accrued from the delivery had the on-field umpire originally called a No ball. Where the batsmen crossed while the ball was in the air before being caught, the batsmen shall remain at the same ends as if the striker had been dismissed, but no runs shall be credited to the striker even if one (or more) runs were completed prior to the catch being taken.

2.6 Cameras On or Over the Field of Play

- 2.6.1 The on-field umpires shall be entitled to refer to the third umpire for a decision as to whether the ball has at any time during the normal course of play come into contact with any part of the camera, its apparatus or its cables above the playing area, as contemplated in clause 20.1.3.
- 2.6.2 Where an on-field umpire wishes to use the assistance of the third umpire in this circumstance, he/she shall communicate with the third umpire by use of a two-way radio and the third umpire shall convey his/her decision to the bowler's end umpire by the same method.
- 2.6.3 A decision shall be made immediately and cannot be changed thereafter. If the television evidence is inconclusive as to whether or not the ball has come into contact with any part of the camera, its apparatus or its cables above the playing area, the default presumption shall be in favour of no contact having been made.
- 2.6.4 The third umpire may initiate contact with the on-field umpire by two-way radio if TV coverage shows the ball to have been in contact with any part of the camera or its cables above the playing area as envisaged under this paragraph.

3 PLAYER REVIEW

The following paragraphs shall operate in addition to and in conjunction with paragraph 2 (Umpire Review).

3.1 Circumstances in which a Player Review may be requested

- 3.1.1 A player may request a review of any decision taken by the on-field umpires concerning whether or not a batsman is dismissed, with the exception of 'Timed Out' (Player Review).
- 3.1.2 No other decisions made by the umpires are eligible for a Player Review with the exception of Fair Catch/Bump Ball (even after the third umpire has been consulted and the decision communicated).

- 3.1.3 Only the batsman involved in a dismissal may request a Player Review of an Out decision and only the captain (or acting captain) of the fielding team may request a Player Review of a Not out decision.
- 3.1.4 A decision concerning whether or not a batsman is dismissed that could have been the subject of a Umpire Review under paragraph 2 is eligible for a Player Review as soon as it is clear that the on-field umpire has chosen not to initiate the Umpire Review.

3.2 The manner of requesting the Player Review

- 3.2.1 The request shall be made by the player making a 'T' sign with both forearms at head height.
- 3.2.2 The total time elapsed between the ball becoming dead and the review request being made shall be no more than 15 seconds. The only exception permitted shall be when an Umpire Review for Fair Catch or Bump Ball (as permitted in paragraph 2.2 above) is required to answer an appeal for a caught decision, in which case either team is able to request a Player Review of that caught decision within 15 seconds of the decision being communicated. The bowler's end umpire shall provide the relevant player with a prompt after 10 seconds if the request has not been made at that time and the player shall request the review immediately thereafter. If the on-field umpires believe that a request has not been made within the 15 second time limit, they shall decline the request for a Player Review.
- 3.2.3 The captain may consult with the bowler and other fielders, and the two batsmen may consult with each other prior to deciding whether to request a Player Review. Under no circumstances is any player permitted to query an umpire about any aspect of a decision before deciding on whether or not to request a Player Review. If the on-field umpires believe that the captain or either batsman has received direct or indirect input emanating other than from the players on the field, then they may at their discretion decline the request for a Player Review. In particular, signals from the dressing room must not be given.
- 3.2.4 No replays, either at normal speed or slow motion, shall be shown on a big screen to spectators until the 15 second time limit allowed for requesting a Player Review has elapsed. The only exception to this provision is where a Player Review of a caught decision is requested after the Umpire Review of a Fair Catch or Bump Ball has concluded, as detailed in paragraph 3.2.2 above (due to the fact that replays may have been shown on the big screen during that Umpire Review process).
- 3.2.5 Where either on-field umpire initiates an Umpire Review, this does not preclude a player seeking a Player Review of a separate incident from the same delivery. The request for a Player Review may be made after the Umpire Review, provided the request is still within the 15 second time limit described in paragraph 3.2.2 above. (See paragraphs 3.9.2 and 3.9.3 below for the process for addressing both an Umpire and Player Review).
- 3.2.6 A request for a Player Review cannot be withdrawn once it has been made.

3.3 The process of consultation

- 3.3.1 On receipt of an eligible and timely request for a Player Review, the relevant on-field umpire shall make the sign of a shape of a TV screen with his/her hands in the normal way.
- 3.3.2 The relevant on-field umpire shall initiate communication with the third umpire by confirming:
- 3.3.2.1 That a Player Review has been requested,
- 3.3.2.2 The mode of dismissal for which the relevant on-field umpire adjudicated the appeal,
- 3.3.2.3 The decision that has been made (Out or Not out), and;
- 3.3.2.4 For LBW appeals, where relevant, if the bowler's end umpire believed that the striker made no genuine attempt to play the ball with the bat (the default presumption of the third umpire in the absence of any information on this point from the bowler's end umpire shall be that a genuine attempt to play the ball with the bat was made).
- 3.3.3 A two-way consultation process shall begin to investigate whether there is anything that the third umpire can see or hear which would indicate that the on-field umpire should change his/her original decision.
- 3.3.4 The third umpire shall not withhold any factual information which may help in the decision making process. In particular, in reviewing a dismissal, if the third umpire believes that the batsman may instead be Out by any other mode of dismissal, he/she shall advise the on-field umpire accordingly. The process of consultation described in this paragraph in respect of such other mode of dismissal shall then be conducted as if the batsman has been given Not out.
- 3.3.5 The third umpire shall initially check all modes of No ball except for the bowler using an Illegal Bowling Action (subject to the proviso that the third umpire may review whether the bowler has used a prohibited Specific Variation under Article 6.2 of the Illegal Bowling Regulations), where appropriate advising the on-field umpire accordingly.
- 3.3.6 If despite the available technology, the third umpire is unable to decide with a high degree of confidence whether the original on-field decision should be changed, then he/she shall report that the replays are 'inconclusive', and that the on-field decision shall stand. The third umpire shall not give answers conveying likelihoods or probabilities.
- 3.3.7 In circumstances where the television technology (all or parts thereof) is not available to the third umpire or fails for whatever reason, the third umpire shall advise the on-field umpire of this fact but still provide any relevant factual information that may be ascertained from the available television replays and other technology.

- 3.3.8 The on-field umpire shall then make his/her decision based on the information provided by the third umpire, any other factual information offered by the third umpire and his/her recollection and opinion of the original incident.
- 3.3.9 The on-field umpire shall reverse his/her decision if the nature of the supplementary information received from the third umpire leads him/her to conclude that his/her original decision was incorrect.

3.4 Review of LBW Decisions

- 3.4.1 In assessing whether a batsman is Out LBW in accordance with clause 36, the third umpire shall first judge whether the delivery is fair (as set out in clause 36.1.1), and second, whether or not the ball has touched the bat before being intercepted by any part of the striker's person (as set out in clause 36.1.3).
- 3.4.2 If the batsman is still eligible to be Out, the ball-tracking technology shall then present three pieces of information to the third umpire relating to the path of the ball:
- 3.4.2.1 The point of pitching (where applicable) (PITCHING)
- 3.4.2.2 The position of the ball at the point of first interception (IMPACT)
- 3.4.2.3 Whether the ball would have hit the wicket (WICKET)
- 3.4.3 This Decision Review System (DRS) and Third Umpire Protocol includes a category of Umpire's Call, which shall be the conclusion reported where the technology indicates a marginal decision in respect of either the point of first interception or whether the ball would have hit the stumps.
- 3.4.4 **PITCHING**
- 3.4.4.1 The interpretation of "pitches in line between wicket and wicket" in clause 36.1.2 shall refer to the position of the centre of the ball at the point of pitching, in relation to the Pitching Zone.
- 3.4.4.2 The Pitching Zone is defined as a two dimensional area on the pitch between both sets of stumps with its boundaries consisting of the base of both sets of stumps and a line between the outside of the outer stumps at each end.
- 3.4.4.3 Where applicable, the ball-tracking technology shall report that the ball pitched in one of the following three areas in relation to the Pitching Zone:

In Line	The centre of the ball was inside the Pitching Zone
Outside Off	The centre of the ball was outside, and to the off side of, the Pitching Zone
Outside Leg	The centre of the ball was outside, and to the leg side of, the Pitching Zone

- 3.4.4.4 Subject to the satisfaction of the other elements of clause 36, the batsman can be Out if the ball-tracking technology reports that the ball pitched Outside Off or In Line, but the batsman shall be Not out if the ball pitched Outside Leg.

3.4.5 IMPACT

- 3.4.5.1 The interpretation of “the (first) point of impact, even if in above the level of the balls, is between wicket and wicket” in clause 36.1.4 shall refer to the position of the ball at the point of first interception, in relation to the Impact Zone.
- 3.4.5.2 The Impact Zone is defined as a three dimensional space extending between both wickets to an indefinite height and with its boundaries consisting of a line between the outside of the outer stumps at each end.
- 3.4.5.3 The ball-tracking technology shall report that the point of first interception was in one of the following categories in relation to the Impact Zone:

In Line	The centre of the ball was inside the Impact Zone
Umpire's Call	Some part of the ball was inside the Impact Zone, but the centre of the ball was outside the Impact Zone, with the further sub-category of 'Umpire's Call (off side)' where the centre of the ball was to the off side of the Impact Zone and the bowler's end umpire communicates to the third umpire that no genuine attempt to play the ball was made by the batsman.
Outside	No part of the ball was inside the Impact Zone, with the further sub-categories of 'Outside (off)' and 'Outside (leg)' to indicate the location of the point of first interception in relation to the Impact Zone when the bowler's end umpire communicates to the third umpire that no genuine attempt to play the ball was made by the batsman.

- 3.4.5.4 Where a Not out decision is being reviewed, and it is judged that the batsman has made a genuine attempt to play the ball, the ball-tracking technology must report that the point of first interception was In Line for the batsman to be eligible to be given Out, otherwise the batsman shall remain Not out.
- 3.4.5.5 Where a Not out decision is being reviewed, and it is judged that the batsman has made no genuine attempt to play the ball, the ball-tracking technology must report that the point of impact was In Line, or Umpire's Call (off side), or Outside (off) for the batsman to be eligible to be given Out, otherwise the batsman shall remain Not out.

- 3.4.5.6 Where an Out decision is being reviewed, and it is judged that the batsman has made a genuine attempt to play the ball, the ball-tracking technology must report that the point of first interception was Outside for the decision to be reversed to Not out, otherwise the batsman shall remain eligible to be given Out.

- 3.4.5.7 Where an Out decision is being reviewed, and it is judged that the batsman has made no genuine attempt to play the ball, the ball-tracking technology must report that the point of first interception was Outside (leg) for the decision to be reversed to Not out, otherwise the batsman shall remain eligible to be given Out.

3.4.6 WICKET

- 3.4.6.1 The interpretation of whether “the ball would have hit the wicket” in clause 36.1.5 shall refer to position of the ball as it either hits or passes the wicket, in relation to the Wicket Zone.
- 3.4.6.2 The Wicket Zone is defined as a two dimensional area whose boundaries are the outside of the outer stumps, the base of the stumps and the bottom of the balls.
- 3.4.6.3 The ball-tracking technology shall report whether the ball would have hit the wicket with reference to the following three categories:

Hitting	The ball was hitting the wicket, and the centre of the ball was inside the Wicket Zone
Umpire's Call	The ball was hitting the wicket, but the centre of the ball was not inside the Wicket Zone
Missing	The ball was missing the wicket

- 3.4.6.4 Where a Not out decision is being reviewed, the ball-tracking technology must report that the ball was Hitting for the batsman to be eligible to be given Out, otherwise the batsman shall remain Not out.

However, where the evidence shows that the ball was Hitting, the point of first interception was In Line, and the ball pitched In Line or Outside Off, but that:

- The point of first interception was 300cm or more from the stumps; or
- The point of first interception was more than 250cm but less than 300cm from the stumps and the distance between the point of pitching and the point of first interception was less than 40cm,

the on-field decision shall stand (that is, Not out).

- 3.4.6.5 Where an Out decision is being reviewed, the ball-tracking technology must report that the ball was Missing for the on-field decision to be reversed to Not out, otherwise the batsman shall remain eligible to be given Out.

- 3.4.7 When the ball strikes the batsman on the full, and the evidence provided by the ball-tracking technology indicates that the ball would have pitched before striking or passing the wicket, there will be no information available from that delivery that will allow the ball-tracking technology to accurately predict the height of the ball after pitching.
- 3.4.8 With regard to determining whether the ball would have hit the wicket under these circumstances, the ball-tracking technology shall project the line of the ball in accordance with clause 36.2.3 (it is to be assumed that the path of the ball before interception would have continued after interception, irrespective of whether the ball might have pitched subsequently or not), and display the simulated path of the ball from directly above the wicket.
- 3.4.9 The third umpire shall advise the bowler's end umpire only on the point of first interception and whether the ball would have hit the stumps (in line with the process set out in paragraph 3.4 above), but shall make no comment on the predicted height of the ball after pitching, which shall remain a judgment of the bowler's end umpire.
- 3.5 The process for communicating the final decision**
- 3.5.1 For Player Reviews concerning potential dismissals, the relevant on-field umpire shall indicate Out by raising his/her finger above his/her head in a normal yet prominent manner or indicate Not out by the call of 'not out' and by crossing his/her hands in a horizontal position side to side in front and above his/her waist three times. Where the decision is a reversal of the on-field umpire's previous decision, he/she shall make the 'revoke last signal' indication immediately prior to the above.
- 3.5.2 If the mode of dismissal is not obvious or not the same as that on which the original decision was based, then the umpire shall advise the scorers via the third umpire.
- 3.6 Number of Player Review requests permitted**
- 3.6.1 In each innings, each team shall be allowed to make a maximum of two Player Review requests that are categorised as 'Unsuccessful' (as set out in paragraph 3.6.3 below).
- 3.6.2 Where a request for a Player Review results in the original on-field decision being reversed, then the Player Review shall be categorised as 'Successful' and shall not count towards the innings limit.
- 3.6.3 Where a request for a Player Review results in the original on-field decision remaining unchanged (other than in the circumstances set out in paragraphs 3.6.4, 3.6.6 or 3.6.8), the Player Review shall be categorised as 'Unsuccessful'.
- 3.6.4 Where a request for a Player Review of an LBW decision results in the on-field decision remaining unchanged solely on the basis of an Umpire's Call, the Player Review shall be categorised as 'Unchanged – Umpire's Call'. A Player Review categorised as 'Unchanged – Umpire's Call' shall not count towards the innings limit set out in paragraph 3.6.1.
- 3.6.5 Where, following a request for a Player Review, the original on-field decision of Out is unchanged, but for a different mode of dismissal from the original on-field decision, then the Player Review shall still be categorised as 'Unsuccessful'.
- 3.6.6 Where, following a request for a Player Review, the original on-field decision of Not out is unchanged on account of the delivery being a No ball (for any reason), thereby not requiring any further evaluation, the Player Review shall not be counted as 'Unsuccessful' and accordingly shall not count towards the innings limit set out in paragraph 3.6.1.
- 3.6.7 Where a Player Review and an Umpire Review are requested from the same delivery and the decision of the third umpire from the Umpire Review renders the Player Review unnecessary (see paragraphs 3.9.2 and 3.9.3), the Player Review request shall be disregarded and accordingly shall not count towards the innings limit set out in paragraph 3.6.1.
- 3.6.8 A Player Review categorised as 'Unsuccessful' may be reinstated by the ICC Match Referee at his/her sole discretion (if appropriate after consultation with the ICC Technical Official and/or the television broadcast director) if the Player Review could not properly be concluded due to a failure of the technology. Any such decision shall be final and shall be taken as soon as possible, being communicated to both teams once all the relevant facts have been ascertained by the ICC Match Referee. A Player Review categorised as 'Unsuccessful' shall not be reinstated if, despite any technical failures, the correct decision could still have been made using the other available technology. Similarly, a Player Review categorised as 'Unsuccessful' shall not be reinstated where the technology worked as intended, but the evidence gleaned from its use was inconclusive.
- 3.6.9 The third umpire shall be responsible for counting the number of Player Reviews categorised as 'Unsuccessful' and shall advise the on-field umpires once either team has exhausted their allowance for the innings.

- 3.6.10 The scoreboard shall display, for the innings in progress, the number of Player Reviews remaining available to each team.

CATEGORY OF PLAYER REVIEW	OUTCOME OF PLAYER REVIEW	CONSEQUENCE OF PLAYER REVIEW
Successful (paragraph 3.6.2)	On-field decision reversed	Does not count towards innings limit set out in paragraph 3.6.1
Unsuccessful (paragraphs 3.6.3 and 3.6.5)	On-field decision unchanged	Counts towards innings limit set out in paragraph 3.6.1
Unchanged – Umpire's Call (paragraph 3.6.4)	On-field decision unchanged	Does not count towards innings limit set out in paragraph 3.6.1
No ball – no evaluation required (paragraph 3.6.6)	On-field decision unchanged	Does not count towards innings limit set out in paragraph 3.6.1
Failure of technology (paragraph 3.6.8)	On-field decision unchanged	Does not count towards innings limit set out in paragraph 3.6.1

- 3.8.15 Approved heat-based edge detection technology:

- Hot Spot cameras (BBG Sports)

- 3.8.16 LED Wickets (using the lights to indicate if the wicket is broken, as set out in paragraph 4.2):

- Zing Bails and Stumps

- 3.8.2 In addition, other forms of technology may be used subject to the ICC being satisfied that the required standards of accuracy and time efficiency can be met.
- 3.8.3 Where practical usage or further testing indicates that any of the above forms of technology cannot reliably provide accurate and timely information, then it may be removed prior to or during a match. The final decision regarding the technology to be used in a given match shall be taken by the ICC Match Referee in consultation with the ICC Technical Official, ICC management and the competing teams' governing bodies.

3.7 Dead ball

- 3.7.1 If following a Player Review request, an original decision of Out is changed to Not out, then the ball is still deemed to have become dead when the original decision was made (as per clause 20.1.1.3). The batting side, while benefiting from the reversal of the dismissal, shall not benefit from any runs that may subsequently have accrued from the delivery had the on-field umpire originally made a Not out decision, other than any No ball penalty that could arise under paragraph 3.3.5 above.
- 3.7.2 If an original decision of Not out is changed to Out, the ball shall retrospectively be deemed to have become dead from the moment of the dismissal event. All subsequent events, including any runs scored, shall be ignored.

3.8 Use of technology

- 3.8.1 The following technology may be used by the third umpire during a Player Review:
- 3.8.1.1 Replays, at any speed, from any available broadcast camera
- 3.8.1.2 Sound from the stump microphones with the replays at normal speed and slow motion
- 3.8.1.3 Approved ball-tracking technology:
- HawkEye (HawkEye Innovations), or;
 - VirtualEye (ARL)
- 3.8.1.4 Approved sound-based edge detection technology:
- Real-Time Snickometer (BBG Sports), or;
 - UltraEdge (HawkEye Innovations)

3.9 Combining Umpire Review with Player Review

- 3.9.1 If an Umpire Review (under paragraph 2) and a request for a Player Review (under paragraph 3) are made following the same delivery but relating to separate modes of dismissal, the following process shall apply.
- 3.9.2 The Umpire Review shall be carried out prior to the Player Review if all of the following conditions apply:
- 3.9.2.1 The Player Review has been requested by the fielding side
- 3.9.2.2 The Umpire Review and the Player Review both relate to the dismissal of the same batsman
- 3.9.2.3 If the batsman is out, the number of runs scored from the delivery would be the same for both modes of dismissal
- 3.9.2.4 If the batsman is out, the batsman on strike for the next delivery would be the same for both modes of dismissal.
- 3.9.3 If the Umpire Review leads the third umpire to make a decision of Out, then this shall be displayed in the usual manner and the Player Review shall not be undertaken. If the Umpire Review results in a Not out decision, then the third umpire shall make no public decision but shall proceed to address the request for a Player Review.
- 3.9.4 For illustration, following an LBW appeal which is given Not out by the bowler's end umpire, the striker sets off for a run, is sent back and there is an appeal for his run out. The players request that the LBW decision is reviewed and the umpires request that the run out be reviewed. The four criteria above are satisfied, so the run out referral is determined first. Should the appeal for run out be Out, then there is no requirement for the LBW review to take place.
- 3.9.5 In all other circumstances, the incidents shall be addressed in chronological order. If the conclusion from the first incident is that a batsman is dismissed, then the ball would be deemed to have become dead at that point, rendering investigation of the second incident unnecessary.

4 INTERPRETATION OF PLAYING CONDITIONS

- 4.1 When using a replay to determine the moment at which the wicket has been put down (as per clause 29.1), the third umpire shall deem this to be the first frame in which one of the bails is shown (or can be deduced) to have lost all contact with the top of the stumps and subsequent frames show the bail permanently removed from the top of the stumps.
- 4.2 Where LED Wickets are used (as provided for in paragraph 3.8.1.6) the moment at which the wicket has been put down (as per clause 29.1) shall be deemed to be the first frame in which the LED lights are illuminated and subsequent frames show the bail permanently removed from the top of the stumps.

APPENDIX E

CALCULATIONS

Calculation Template for Last Day of Test Match

This template applies to any interruption on the last day which causes a loss in actual playing time, (i.e. an interruption longer than the amount of extra time available) and where play resumes after the scheduled tea interval.

Where play resumes prior to tea, then the calculation of overs remaining in the day is performed as per Days 1-4, with the scheduled time for the last hour affected only by the adding of any extra time. Lines A, B, C, D and E should be completed at the start of an interruption on the final day.

If play resumes without any lost playing time, or prior to the tea interval, then this sheet can be discarded.

Once the length of interruption exceeds D and actual playing time is lost, then line F can be completed. Lines G and H can be completed immediately if the interruption starts after tea, otherwise as soon as the interruption includes the tea interval.

CALCULATION TEMPLATE FOR LAST DAY OF TEST MATCH

A	Start of interruption	_____
B	Minimum overs remaining before start of last hour as at time A (see Note 1)	_____
C	Time required to bowl minimum overs @ 4 mins per over (B x 4)	_____
D	Extra time available as at time A	_____
E	Scheduled time for last hour as at time A	_____
F	Rescheduled time for last hour (Time basis) (D + E)	_____
G	Length of intervals covered by interruption: enter 40 (lunch), 20 (tea), 60 (both) or 0 (neither)	_____
H	Rescheduled time for last hour (Overs basis) (A + C + D + G)	_____
I	Later of F and H above	_____
J	Time play resumes	_____

Case A: If J is earlier than I, play resumes prior to the last hour

K	Minutes playing time lost (J – A – D – G)	_____
L	Overs lost @ 4 mins per over (see Note 2)	_____
M	Minimum overs before start of last hour (B – L) (See Note 1) The last hour then starts at the later of the time in Line F and the completion of the overs in Line M	_____

Case B: If J is not earlier than I, play resumes in the last hour

K	Time for last hour to finish (I plus 60 minutes)	_____
L	Minutes remaining in last hour (K – J)	_____
M	Overs remaining in last hour (L/4 mins or part thereof) (see Note 1)	_____

Note 1: If an interruption occurs part-way through an over, in Row B enter the number of full overs remaining, ignoring the part over. Then in Row M, add back the part over to the minimum overs to be bowled on resumption.

Note 2: The actual overs lost for a given interruption will also reflect any earlier interruptions in the day, so that one over is lost in the day for each full four minutes of aggregated playing time lost. For example, 15 minutes loses 3 overs, but another 15 minute delay loses 4 overs.

APPENDIX F

USE OF ELECTRONIC COMMUNICATIONS EQUIPMENT

The use of electronic communication devices and equipment of any kind to communicate with players on the field of play shall not be permitted.

ICC MEN'S ONE DAY INTERNATIONAL PLAYING CONDITIONS

Effective from 1 August 2019

ICC MEN'S ONE DAY INTERNATIONAL PLAYING CONDITIONS

CONTENTS

1	THE PLAYERS	4.3
2	THE UMPIRES	4.6
3	THE SCORERS	4.11
4	THE BALL	4.12
5	THE BAT	4.12
6	THE PITCH	4.14
7	THE CREASES	4.16
8	THE WICKETS	4.17
9	PREPARATION AND MAINTENANCE OF THE PLAYING AREA	4.18
10	COVERING THE PITCH	4.20
11	INTERVALS	4.20
12	START OF PLAY; CESSATION OF PLAY	4.21
13	INNINGS	4.23
14	THE FOLLOW-ON	4.27
15	DECLARATION AND FORFEITURE	4.27
16	THE RESULT	4.27
17	THE OVER	4.31
18	SCORING RUNS	4.33
19	BOUNDARIES	4.36
20	DEAD BALL	4.38
21	NO BALL	4.41
22	WIDE BALL	4.44
23	BYE AND LEG BYE	4.46
24	FIELDER'S ABSENCE; SUBSTITUTES	4.47
25	BATSMAN'S INNINGS	4.49
26	PRACTICE ON THE FIELD	4.50
27	THE WICKET-KEEPER	4.51
28	THE FIELDER	4.53
29	THE WICKET IS DOWN	4.57
30	BATSMAN OUT OF HIS GROUND	4.58
31	APPEALS	4.59
32	BOWLED	4.60
33	CAUGHT	4.60
34	HIT THE BALL TWICE	4.62
35	HIT WICKET	4.63
36	LEG BEFORE WICKET	4.63
37	OBSTRUCTING THE FIELD	4.64
38	RUN OUT	4.66

39	STUMPED	4.67
40	TIMED OUT	4.67
41	UNFAIR PLAY	4.68
42	PLAYERS' CONDUCT	4.80

APPENDIX A DEFINITIONS 4.84

1	The match	4.84
2	Implements and equipment	4.85
3	The playing area	4.85
4	Positioning	4.85
5	Umpires and decision-making	4.86
6	Batsmen	4.87
7	Fielders	4.88
8	Substitutes and Concussion Replacements	4.88
9	Bowlers	4.88
10	The ball	4.89
11	Runs	4.89
12	The person	4.89
13	Off side / on side; in front of / behind the popping crease	4.91

APPENDIX B EQUIPMENT 4.92

1	The Bat	4.92
2	The wickets	4.95
3	Wicket-keeping gloves	4.96

APPENDIX C THE VENUE 4.97

1	The pitch and the creases	4.97
2	Restriction on the placement of fielders	4.98
3	Advertising on grounds, perimeter boards and sight-screens	4.99
4	Markings on outfield	4.99

**APPENDIX D DECISION REVIEW SYSTEM (DRS)
AND THIRD UMPIRE PROTOCOL** 4.100

1	General	4.100
2	Umpire Review	4.102
3	Player Review	4.105
4	Interpretation of Playing Conditions	4.114

APPENDIX E CALCULATIONS 4.115

APPENDIX F APPLICATION OF THE RESERVE DAY 4.118

APPENDIX G USE OF ELECTRONIC COMMUNICATIONS EQUIPMENT 4.119

PREAMBLE THE SPIRIT OF CRICKET

Cricket owes much of its appeal and enjoyment to the fact that it should be played not only according to the Laws (which are incorporated within these Playing Conditions), but also within the Spirit of Cricket.

The major responsibility for ensuring fair play rests with the captains, but extends to all players, match officials and, especially in junior cricket, teachers, coaches and parents.

Respect is central to the Spirit of Cricket.

Respect your captain, team-mates, opponents and the authority of the umpires.

Play hard and play fair.

Accept the umpire's decision.

Create a positive atmosphere by your own conduct, and encourage others to do likewise.

Show self-discipline, even when things go against you.

Congratulate the opposition on their successes, and enjoy those of your own team.

Thank the officials and your opposition at the end of the match, whatever the result.

Cricket is an exciting game that encourages leadership, friendship and teamwork, which brings together people from different nationalities, cultures and religions, especially when played within the Spirit of Cricket.

1 THE PLAYERS

1.1 Number of players

A match is played between two sides, each of eleven players, one of whom shall be captain.

1.2 Nomination and replacement of players

1.2.1 Each captain shall nominate 11 players plus a maximum of 4 substitute fielders in writing to the ICC Match Referee before the toss. Other than set out in clause 1.2.7, no player (member of the playing eleven) may be changed after the nomination without the consent of the opposing captain.

1.2.2 Only those nominated as substitute fielders shall be entitled to act as substitute fielders during the match, unless the ICC Match Referee, in exceptional circumstances, allows subsequent additions.

1.2.3 All those nominated including those nominated as substitute fielders, as well as any Concussion Replacements, must be eligible to play for that particular team and by such nomination the nominees shall warrant that they are so eligible.

1.2.4 In addition, by their nomination, the nominees shall be deemed to have agreed to abide by all the applicable ICC Regulations pertaining to international cricket and in particular, the Clothing and Equipment Regulations, the Code of Conduct for Players and Player Support Personnel (hereafter referred to as the ICC Code of Conduct), the Anti-Racism Code for Players and Player Support Personnel, the Anti-Doping Code and the Anti-Corruption Code.

- 1.2.5 A player or player support personnel who has been suspended from participating in a match shall not, from the toss of the coin and for the remainder of the match thereafter:
- 1.2.5.1 Be nominated as, or carry out any of the duties or responsibilities of a substitute fielder, or
- 1.2.5.2 Enter any part of the playing area (which shall include the field of play and the area between the boundary and the perimeter boards) at any time, including any scheduled or unscheduled breaks in play.
- 1.2.6 A player who has been suspended from participating in a match shall be permitted from the toss of the coin and for the remainder of the match thereafter be permitted to enter the players' dressing room provided that the players' dressing room (or any part thereof) for the match is not within the playing area described in clause 1.2.5.2 above (for example, the player is not permitted to enter the on-field 'dug-out').
- 1.2.7 If a player sustains a concussion or suspected concussion as a result of a head or neck injury during the course of the relevant match, a Concussion Replacement may be permitted in the following circumstances:
- 1.2.7.1 the head or neck injury must have been sustained during play and within the playing area described in clause 1.2.5.2 above;
- 1.2.7.2 a concussion or suspected concussion must have been formally diagnosed by the Team Medical Representative;
- 1.2.7.3 the Team Medical Representative or Team Manager shall submit a Concussion Replacement Request to the ICC Match Referee on a standard form, which shall:
- 1.2.7.3.1 identify the player who has sustained the concussion or suspected concussion;
- 1.2.7.3.2 specify the incident in which the concussion or suspected concussion was sustained, including the time at which it occurred;
- 1.2.7.3.3 confirm that, following an examination, the Team Medical Representative believes or suspects that the player has sustained a concussion as a result of the incident specified in 1.2.7.3.2 above; and
- 1.2.7.3.4 identify the requested Concussion Replacement, who shall be a like-for-like replacement for the player who has sustained the concussion or suspected concussion.
- 1.2.7.4 The Concussion Replacement Request must be submitted as soon as possible after the incident specified in 1.2.7.3.2 if a Concussion Replacement is to be permitted.

- 1.2.8 The ICC Match Referee should ordinarily approve a Concussion Replacement Request if the replacement is a like-for-like player whose inclusion will not excessively advantage his team for the remainder of the match.
- 1.2.8.1 In assessing whether the nominated Concussion Replacement should be considered a like-for-like player, the ICC Match Referee should consider the likely role the concussed player would have played during the remainder of the match, and the normal role that would be performed by the nominated Concussion Replacement.
- 1.2.8.2 If the ICC Match Referee believes that the inclusion of the nominated Concussion Replacement, when performing their normal role, would excessively advantage their team, the Match Referee may impose such conditions upon the identity and involvement of the Concussion Replacement as he/she sees fit, in line with the overriding objective of facilitating a like-for-like replacement for the concussed player.
- 1.2.8.3 The ICC Match Referee may, in reviewing a Concussion Replacement Request made in accordance with clause 1.2.7.3, request any such further information as may be required in order to make the determination required under clauses 1.2.8.1 and 1.2.8.2.
- 1.2.9 The decision of the ICC Match Referee in relation to any Concussion Replacement Request shall be final and neither team shall have any right of appeal.
- 1.2.10 Once the Concussion Replacement has been approved by the ICC Match Referee, the replaced player shall play no further part in the match.
- 1.2.11 Both the Concussion Replacement and the replaced player shall be considered to have played in the match for records and statistical purposes.

1.3 Captain

- 1.3.1 If at any time the captain is not available, a deputy shall act for him.
- 1.3.2 If a captain is not available to nominate the players, then any person associated with that team may act as his deputy to do so. See clause 1.2.
- 1.3.3 At any time after the nomination of the players, only a nominated player can act as deputy in discharging the duties and responsibilities of the captain as stated in these Playing Conditions, including at the toss. See clause 13.4 (The toss).

1.4 Responsibility of captains

The captains are responsible at all times for ensuring that play is conducted within The Spirit of Cricket as well as within these Playing Conditions.

2 THE UMPIRES**2.1 Appointment and attendance**

The following rules for the selection and appointment of ODI umpires shall be followed as far as it is practicable to do so:

- 2.1.1 The umpires shall control the game as required by these Playing Conditions, with absolute impartiality and shall be present at the ground at least two hours before the scheduled start of the first day's play, and at least 1.5 hours before the scheduled start of play.
- 2.1.2 The ICC shall establish an 'Elite Panel' of umpires who shall be contracted to the ICC.
- 2.1.3 Each Full Member shall nominate from its panel of first class umpires up to four umpires to an 'International Panel'.
- 2.1.4 The ICC shall appoint one umpire to stand in each ODI match. Such umpire shall not be from the same country as the participating teams and shall be selected from the 'Elite Panel' or the 'International Panel'.
- 2.1.5 The Home Board shall appoint one umpire to stand in each ODI. Such umpire shall be selected from its umpires on the Elite or International Panel.
- 2.1.6 As early as possible before each ODI Match, the ICC will advise the Home Board of the names of its appointees and the Home Board will advise the Manager of the visiting team of all umpires' names.
- 2.1.7 In ODI matches where the DRS is used, the ICC will appoint a third umpire who shall act as the emergency on-field umpire and officiate in regard to the DRS. Such third umpire shall not be from the same country as the participating teams and shall be appointed from the 'Elite Panel' or the 'International Panel'.
- 2.1.8 In all other ODI matches, the third umpire will be appointed by the Home Board and shall act as the emergency on-field umpire and officiate in regard to TV replays. Such appointment shall be made from the 'Elite Panel' or the 'International Panel'.
 - 2.1.8.1 The playing conditions governing the use of the DRS and the third umpire are included in Appendix D.
- 2.1.9 The Home Board shall also appoint a fourth umpire for each ODI match from its panel of first class umpires. The fourth umpire shall act as the emergency third umpire. In 'DRS' ODI matches the fourth umpire shall be appointed from the "International Panel".
- 2.1.10 The ICC shall appoint the match referee for all matches (ICC Match Referee).
- 2.1.11 The ICC Match Referee shall not be from the same country as the participating teams.
- 2.1.12 Neither team will have a right of objection to the appointment of any umpire or match referee.

2.2 Change of umpire

An umpire shall not be changed during the match, other than in exceptional circumstances, unless he/she is injured or ill.

2.3 Consultation with Home Board

Before the match the umpires shall consult with the Home Board to determine;

- 2.3.1 the balls to be used during the match. See clause 4 (The ball).
 - 2.3.2 the hours of play and the times and durations of any agreed intervals.
 - 2.3.3 which clock or watch and back-up time piece is to be used during the match.
 - 2.3.4 the boundary of the field of play. See clause 19 (Boundaries).
 - 2.3.5 the use of covers. See clause 10 (Covering the pitch).
 - 2.3.6 any special conditions of play affecting the conduct of the match.
- inform the scorers of agreements in 2.3.2, 2.3.3, 2.3.4 and 2.3.6.

2.4 The wickets, creases and boundaries

Before the toss and during the match, the umpires shall satisfy themselves that:

- 2.4.1 the wickets are properly pitched. See clause 8 (The wickets)
- 2.4.2 the creases are correctly marked. See clause 7 (The creases).
- 2.4.3 the boundary of the field of play complies with the requirements of clauses 19.1 (Determining the boundary of the field of play), 19.2 (Identifying and marking the boundary) and 19.3 (Restoring the boundary).

2.5 Conduct of the match, implements and equipment

Before the toss and during the match, the umpires shall satisfy themselves that

- 2.5.1 the conduct of the match is strictly in accordance with these Playing Conditions.
- 2.5.2 the implements used in the match conform to the following
 - 2.5.2.1 clause 4 (The ball).
 - 2.5.2.2 externally visible requirements of clause 5 (The bat) and paragraph 1 of Appendix B
 - 2.5.2.3 either clauses 8.2 (Size of stumps) and 8.3 (The bails).
- 2.5.3 no player uses equipment other than that permitted. See paragraph 2 of Appendix A. Note particularly therein the interpretation of 'protective helmet'.
- 2.5.4 the wicket-keeper's gloves comply with the requirements of clause 27.2 (Gloves).

2.6 Fair and unfair play

The umpires shall be the sole judges of fair and unfair play.

2.7 Fitness for play

- 2.7.1 It is solely for the umpires together to decide whether either conditions of ground, weather or light or exceptional circumstances mean that it would be dangerous or unreasonable for play to take place.

Conditions shall not be regarded as either dangerous or unreasonable merely because they are not ideal.

The fact that the grass and the ball are wet does not warrant the ground conditions being regarded as unreasonable or dangerous.

- 2.7.2 Conditions shall be regarded as dangerous if there is actual and foreseeable risk to the safety of any player or umpire.
- 2.7.3 Conditions shall be regarded as unreasonable if, although posing no risk to safety, it would not be sensible for play to proceed.
- 2.7.4 If the umpires consider the ground is so wet or slippery as to deprive the bowler of a reasonable foothold, the fielders of the power of free movement, or the batsmen of the ability to play their strokes or to run between the wickets, then these conditions shall be regarded as so bad that it would be dangerous and unreasonable for play to take place.

2.8 Suspension of play in dangerous or unreasonable circumstances

- 2.8.1 All references to ground include the pitch. See clause 6.1 (Area of pitch).
- 2.8.2 If at any time the umpires together agree that the conditions of ground, weather or light, or any other circumstances are dangerous or unreasonable, they shall immediately suspend play, or not allow play to start or to recommence. The decision as to whether conditions are so bad as to warrant such action is one for the umpires alone to make, following consultation with the ICC Match Referee.
- 2.8.3 If circumstances are warranted, the umpires shall stop play and instruct the Ground Authority to take whatever action they can and use whatever equipment is necessary to remove as much dew as possible from the outfield when conditions become unreasonable or dangerous. The umpires may also instruct the ground staff to take such action during scheduled and unscheduled breaks in play.
- 2.8.4 The umpires shall disregard any shadow on the pitch from the stadium or from any permanent object on the ground.
- 2.8.5 Light Meters
- It is the responsibility of the ICC to supply light meters to the match officials to be used in accordance with these playing conditions.
- 2.8.5.1 All light meters shall be uniformly calibrated.

- 2.8.5.2 The umpires shall be entitled to use light meter readings as a guideline for determining whether the light is fit for play in accordance with the criteria set out in clause 2.8.2 above.

- 2.8.5.3 Light meter readings may accordingly be used by the umpires:

- 2.8.5.3.1 To determine whether there has been at any stage a deterioration or improvement in the light.
- 2.8.5.3.2 As benchmarks for the remainder of a match.

2.8.6 Use of artificial lights

If in the opinion of the umpires, natural light is deteriorating to an unfit level, they shall authorize the Ground Authority to use the available artificial lighting so that the match can commence or continue in acceptable conditions.

In the event of power failure or lights malfunction, the provisions relating to the delay or interruption of play due to bad weather or light shall apply.

- 2.8.7 When there is a suspension of play it is the responsibility of the umpires to monitor conditions. They shall make inspections as often as appropriate, unaccompanied by any players or officials. Immediately the umpires together agree that the conditions are no longer dangerous or unreasonable they shall call upon the players to resume play.
- 2.8.8 The safety of all persons within the ground is of paramount importance to the ICC. In the event that of any threatening circumstance, whether actual or perceived (including for example weather, pitch invasions, act of God, etc.), then the umpires, on the advice of the ICC Match Referee, should suspend play and all players and officials should immediately be asked to leave the field of play in a safe and orderly manner and to relocate to a secure and safe area (depending on each particular threat) pending the satisfactory passing or resolution of such threat or risk to the reasonable satisfaction of the umpires, the ICC Match Referee, the head of the relevant Ground Authority, the head of ground security and/or the police as the circumstances may require.
- 2.8.9 Where play is suspended under clause 2.8.8 above the decision to abandon or resume play shall be the responsibility of the ICC Match Referee who shall act only after consultation with the head of ground security and the police.

2.9 Position of umpires

The umpires shall stand where they can best see any act upon which their decision may be required.

Subject to this over-riding consideration, the bowler's end umpire shall stand in a position so as not to interfere with either the bowler's run-up or the striker's view.

The striker's end umpire may elect to stand on the off side instead of the on side of the pitch, provided he/she informs the captain of the fielding side, the striker and the other umpire.

2.10 Umpires changing ends

Shall not apply.

2.11 Disagreement and dispute

Where there is disagreement or dispute about any matter, the umpires together shall make the final decision. See also clause 31.6 (Consultation by umpires).

2.12 Umpire's decision

An umpire may alter any decision provided that such alteration is made promptly. This apart, an umpire's decision, once made, is final.

2.13 Signals

2.13.1 The following code of signals shall be used by umpires.

2.13.1.1 Signals made while the ball is in play

No ball – by extending one arm horizontally.

Out – by raising an index finger above the head.
(If not out, the umpire shall call Not out.)

Wide – by extending both arms horizontally.

Dead ball – by crossing and re-crossing the wrists below the waist.

2.13.1.2 When the ball is dead, the bowler's end umpire shall repeat the signals in clause 2.13.1.1, with the exception of the signal for Out, to the scorers.

2.13.1.3 The signals listed below shall be made to the scorers only when the ball is dead.

Boundary 4 – by waving an arm from side to side finishing with the arm across the chest.

Boundary 6 – by raising both arms above the head.

Bye – by raising an open hand above the head.

Five Penalty runs awarded to the batting side – by repeated tapping of one shoulder with the opposite hand.

Five Penalty runs awarded to the fielding side – by placing one hand on the opposite shoulder.

Leg bye – by touching a raised knee with the hand.

Revoke last signal – by touching both shoulders, each with the opposite hand.

Short run – by bending one arm upwards and touching the nearer shoulder with the tips of the fingers.

Free Hit – after signaling the No ball, the bowler's end umpire extends one arm straight upwards and moves it in a circular motion.

Powerplay Over – by rotating his arm in a large circle.

The following signal is for Level 4 player conduct offences. The signal has two parts, both of which should be acknowledged separately by the scorers.

Level 4 conduct

Part 1 – by putting one arm out to the side of the body and repeatedly raising it and lowering it.

Part 2 – by raising an index finger, held at shoulder height, to the side of the body.

2.13.1.4 All the signals in clause 2.13.1.3 are to be made by the bowler's end umpire except that for Short run, which is to be signalled by the umpire at the end where short running occurs. However, the bowler's end umpire shall be responsible both for the final signal of Short run to the scorers and, if more than one run is short, for informing them as to the number of runs to be recorded.

2.13.2 The umpire shall wait until each signal to the scorers has been separately acknowledged by a scorer before allowing play to proceed.

If several signals are to be used, they should be given in the order that the events occurred.

2.14 Informing the umpires

Wherever the umpires are to receive information from captains or other players under these Playing Conditions, it will be sufficient for one umpire to be so informed and for him/her to inform the other umpire.

2.15 Correctness of scores

Consultation between umpires and scorers on doubtful points is essential. The umpires shall, throughout the match, satisfy themselves as to the correctness of the number of runs scored, the wickets that have fallen and, where appropriate, the number of overs bowled.

The umpires shall ensure that they are able to contact the scorers at any time during the match and at its conclusion to address any issues relating to the correctness of scores.

3 THE SCORERS**3.1 Appointment of scorers**

Two scorers shall be appointed to record all runs scored, all wickets taken and, where appropriate, number of overs bowled.

3.2 Correctness of scores

The scorers shall frequently check to ensure that their records agree and consult with the umpires if necessary. See clause 2.15 (Correctness of scores).

3.3 Acknowledging signals

The scorers shall accept all instructions and signals given to them by the umpires and shall immediately acknowledge each separate signal.

4 THE BALL

4.1 Weight and size

The ball, when new, shall weigh not less than 5.5 ounces/155.9 g, nor more than 5.75 ounces/163 g, and shall measure not less than 8.81 in/22.4 cm, nor more than 9 in/22.9 cm in circumference.

4.2 Approval and control of balls

- 4.2.1 The Home Board shall provide white cricket balls of an approved standard for ODI cricket and spare used balls for changing during a match, which shall also be of the same brand. Note: The Home Board shall be required to advise the Visiting Board of the brand of ball to be used in the match(es) at least 30 days prior to the start of the match(es).
- 4.2.2 The fielding captain or his nominee may select the ball with which he wishes to bowl from the supply provided by the Home Board. The fourth umpire shall take a box containing at least 6 new balls to the dressing room and supervise the selection of the ball.
- 4.2.3 The umpires shall retain possession of the match ball(s) throughout the duration of the match when play is not actually taking place.
- 4.2.4 During play umpires shall periodically and irregularly inspect the condition of the ball and shall retain possession of it at the fall of a wicket, a drinks interval, or any other disruption in play.

4.3 New ball

- 4.3.1 Each fielding team shall have two new balls for its innings, to be used in alternate overs i.e. one from each end.
- 4.3.2 In a match reduced to 25 overs or less per side before the first innings commences, each team shall have only one new ball for its Innings.

4.4 Ball lost or becoming unfit for play

If, during play, the ball cannot be found or recovered or the umpires agree that it has become unfit for play through normal use, the umpires shall replace it with a ball which has had wear comparable with that which the previous ball had received before the need for its replacement. When the ball is replaced, the umpire shall inform the batsmen and the fielding captain.

5 THE BAT

5.1 The bat

- 5.1.1 The bat consists of two parts, a handle and a blade.
- 5.1.2 The basic requirements and measurements of the bat are set out in this clause with detailed specifications in paragraph 1 of Appendix B.

5.2 The handle

- 5.2.1 The handle is to be made principally of cane and/or wood.
- 5.2.2 The part of the handle that is wholly outside the blade is defined to be the upper portion of the handle. It is a straight shaft for holding the bat.
- 5.2.3 The upper portion of the handle may be covered with a grip as defined in paragraph 1.2.2 of Appendix B.

5.3 The blade

- 5.3.1 The blade comprises the whole of the bat apart from the handle as defined in clause 5.2 and in paragraph 1.3 of Appendix B.
- 5.3.2 The blade shall consist solely of wood.

5.4 Protection and repair

Subject to the specifications in paragraph 1.4 of Appendix B. and providing clause 5.5 is not contravened,

- 5.4.1 solely for the purposes of
either
protection from surface damage to the face, sides and shoulders of the blade
or
repair to the blade after surface damage,
material that is not rigid, either at the time of its application to the blade or subsequently, may be placed on these surfaces.
- 5.4.2 for repair of the blade after damage other than surface damage
- 5.4.2.1 solid material may be inserted into the blade.
- 5.4.2.2 The only material permitted for any insertion is wood with minimal essential adhesives.
- 5.4.3 to prevent damage to the toe, material may be placed on that part of the blade but shall not extend over any part of the face, back or sides of the blade.

5.5 Damage to the ball

- 5.5.1 For any part of the bat, covered or uncovered, the hardness of the constituent materials and the surface texture thereof shall not be such that either or both could cause unacceptable damage to the ball.
- 5.5.2 Any material placed on any part of the bat, for whatever purpose, shall similarly not be such that it could cause unacceptable damage to the ball.
- 5.5.3 For the purpose of this clause, unacceptable damage is any change that is greater than normal wear and tear caused by the ball striking the uncovered wooden surface of the blade.

5.6 Contact with the ball

In these clauses,

- 5.6.1 reference to the bat shall imply that the bat is held in the batsman's hand or a glove worn on his hand, unless stated otherwise.
 - 5.6.2 contact between the ball and any of 5.6.2.1 to 5.6.2.4
 - 5.6.2.1 the bat itself
 - 5.6.2.2 the batsman's hand holding the bat
 - 5.6.2.3 any part of a glove worn on the batsman's hand holding the bat
 - 5.6.2.4 any additional materials permitted under 5.4
- shall be regarded as the ball striking or touching the bat or being struck by the bat.

5.7 Bat size limits

- 5.7.1 The overall length of the bat, when the lower portion of the handle is inserted, shall not be more than 38 in/96.52 cm.
- 5.7.2 The blade of the bat shall not exceed the following dimensions:
 - Width: 4.25in / 10.8 cm
 - Depth: 2.64in / 6.7 cm
 - Edges: 1.56in / 4.0cm

Furthermore, it should also be able to pass through a bat gauge as described in paragraph 1.6 of Appendix B.
- 5.7.3 The handle shall not exceed 52% of the overall length of the bat.
- 5.7.4 The material permitted for covering the blade in clause 5.4.1 shall not exceed 0.04 in/0.1 cm in thickness.
- 5.7.5 The maximum permitted thickness of protective material placed on the toe of the blade is 0.12 in/0.3 cm.

5.8 Categories of bat

- 5.8.1 Type A bats conform to clauses 5.1 to 5.7 inclusive.
- 5.8.2 Only Type A bats may be used in ODI matches.

6 THE PITCH**6.1 Area of pitch**

The pitch is a rectangular area of the ground 22 yards/20.12 m in length and 10 ft/3.05 m in width. It is bounded at either end by the bowling creases and on either side by imaginary lines, one each side of the imaginary line joining the centres of the two middle stumps, each parallel to it and 5 ft/1.52 m from it. If the pitch is next to an artificial pitch which is closer than 5 ft/1.52 m from the middle stumps, the pitch on that side will extend only to the junction of the two surfaces. See clauses 8.1 (Description, width and pitching) and 7.2 (The bowling crease).

6.2 Fitness of pitch for play

The umpires shall be the sole judges of the fitness of the pitch for play. See clauses 2.7 (Fitness for play) and 2.8 (Suspension of play in dangerous or unreasonable conditions).

6.3 Selection and preparation

Before the match, the Ground Authority shall be responsible for the selection and preparation of the pitch. During the match, the umpires shall control its use and maintenance.

- 6.3.1 The Ground Authority shall ensure that during the period prior to the start of play and during intervals, the pitch area shall be roped off so as to prevent unauthorised access. (The pitch area shall include an area at least 2 metres beyond the rectangle made by the crease markings at both ends of the pitch).
- 6.3.2 The fourth umpire shall ensure that, prior to the start of play and during any intervals, only authorised staff, the ICC match officials, players, team coaches and authorised television personnel shall be allowed access to the pitch area. Such access shall be subject to the following limitations:
 - 6.3.2.1 Only captains and team coaches may walk on the actual playing surface of the pitch area (outside of the crease markings).
 - 6.3.2.2 Access to the pitch area by television personnel shall be restricted to one camera crew (including one or two television commentators) of the official licensed television broadcaster(s) (but not news crews).
 - 6.3.2.3 No spiked footwear shall be permitted.
 - 6.3.2.4 No one shall be permitted to bounce a ball on the pitch, strike it with a bat or cause damage to the pitch in any other way.
 - 6.3.2.5 Access shall not interfere with pitch preparation.
- 6.3.3 In the event of any dispute, the ICC Match Referee will rule and his ruling will be final.

6.4 Changing the pitch

- 6.4.1 If the on-field umpires decide that it is dangerous or unreasonable for play to continue on the match pitch, they shall stop play and immediately advise the ICC Match Referee.
- 6.4.2 The on-field umpires and the ICC Match Referee shall then consult with both captains.
- 6.4.3 If the captains agree to continue, play shall resume.
- 6.4.4 If the decision is not to resume play, the on-field umpires together with the ICC Match Referee shall consider whether the existing pitch can be repaired and the match resumed from the point it was stopped. In considering whether to authorise such repairs, the ICC Match Referee must consider whether this would place either side at an unfair advantage, given the play that had already taken place on the dangerous pitch.

- 6.4.5 If the decision is that the existing pitch cannot be repaired, then the match is to be abandoned with the following consequences:
- 6.4.5.1 In the event of the required number of overs to constitute a match having been completed at the time the match is abandoned, the result shall be determined according to the provisions of clause 16.4.2.
- 6.4.5.2 In the event of the required number of overs to constitute a match not having been completed, the match will be abandoned as a no result.
- 6.4.6 If the abandonment occurs on the day of the match, the ICC Match Referee shall consult with the Home Board with the objective of finding a way for a new match (including a new nomination of teams and toss) to commence on the same date and venue. Such a match may be played either on the repaired pitch or on another pitch, subject to the ICC Match Referee and the relevant Ground Authority both being satisfied that the new pitch will be of the required ODI standard. The playing time lost between the scheduled start time of the original match and the actual start time of the new match will be covered by the provisions of clause 12.
- 6.4.7 If it is not possible to start a new match on the scheduled day of the match, the relevant officials from the participating Boards shall agree on whether the match can be replayed within the existing tour schedule.
- 6.4.8 Throughout the above decision making processes, the ICC Match Referee shall keep informed both captains and the head of the Ground Authority. The head of the Ground Authority shall ensure that suitable and prompt public announcements are made.

6.5 Non-turf pitches

All ODI matches shall be played on natural turf pitches. The use of PVA and other adhesives in the preparation of pitches is not permitted.

7 THE CREASES

7.1 The creases

The positions of a bowling crease, a popping crease and two return creases shall be marked by white lines, as set out in clauses 7.2, 7.3 and 7.4, at each end of the pitch. See paragraph 1 of Appendix C.

7.2 The bowling crease

The bowling crease, which is the back edge of the crease marking, is the line that marks the end of the pitch, as in clause 6.1 (Area of pitch). It shall be 8 ft 8 in/2.64 m in length.

7.3 The popping crease

The popping crease, which is the back edge of the crease marking, shall be in front of and parallel to the bowling crease and shall be 4 ft/1.22 m from it. The popping crease shall be marked to a minimum of 15 yards/13.71 m on either side of the imaginary line joining the centres of the two middle stumps and shall be considered to be unlimited in length.

7.4 The return creases

The return creases, which are the inside edges of the crease markings, shall be at right angles to the popping crease at a distance of 4 ft 4 in/1.32 m either side of the imaginary line joining the centres of the two middle stumps. Each return crease shall be marked from the popping crease to a minimum of 8 ft/2.44 m behind it and shall be considered to be unlimited in length.

7.5 Additional Crease Markings

As a guideline to the umpires for the calling of Wides on the offside, the crease markings detailed in paragraph 1 of Appendix C may be marked in white at each end of the pitch.

8 THE WICKETS

8.1 Description, width and pitching

Two sets of wickets shall be pitched opposite and parallel to each other in the centres of the bowling creases. Each set shall be 9 in/22.86 cm wide and shall consist of three wooden stumps with two wooden bails on top. See paragraph 2 of Appendix B.

8.2 Size of stumps

The tops of the stumps shall be 28 in/71.12 cm above the playing surface and shall be dome shaped except for the bail grooves. The portion of a stump above the playing surface shall be cylindrical apart from the domed top, with circular section of diameter not less than 1.38 in/3.50 cm nor more than 1.5 in/3.81 cm. See paragraph 2 of Appendix B.

For televised matches the Home Board may provide a slightly larger cylindrical stump to accommodate the stump camera. When the larger stump is used, all three stumps must be exactly the same size.

8.3 The bails

- 8.3.1 The bails, when in position on top of the stumps,
- shall not project more than 0.5 in/1.27 cm above them.
 - shall fit between the stumps without forcing them out of the vertical.
- 8.3.2 Each bail shall conform to the following specifications. See paragraph 2 of Appendix B.
- Overall length 4.31 in/10.95 cm
 - Length of barrel 2.13 in/5.40 cm
 - Longer spigot 1.38 in/3.50 cm
 - Shorter spigot 0.81 in/2.06 cm.
- 8.3.3 The two spigots and the barrel shall have the same centre line.
- 8.3.4 Devices aimed at protecting player safety by limiting the distance that a bail can travel off the stumps will be allowed, subject to the approval of the Home Board and the ICC.

8.4 Dispensing with bails

The umpires may agree to dispense with the use of bails, if necessary. If they so agree then no bails shall be used at either end. The use of bails shall be resumed as soon as conditions permit. See clause 29.4 (Dispensing with bails).

8.5 LED Wickets

The use of approved LED Wickets is permitted. Refer also to paragraphs 3.8.1.6 and 4.2 of Appendix D.

9 PREPARATION AND MAINTENANCE OF THE PLAYING AREA**9.1 Rolling**

The pitch shall not be rolled during the match except as permitted in clauses 9.1.1 and 9.1.2.

9.1.1 Frequency and duration of rolling

During the match the pitch may be rolled at the request of the captain of the side batting second, for a period of not more than 7 minutes, before the start of the second innings.

9.1.2 Rolling after a delayed start

In addition to the rolling permitted above, if, after the toss and before the first innings of the match, the start is delayed, the captain of the batting side may request that the pitch be rolled for not more than 7 minutes. However, if the umpires together agree that the delay has had no significant effect on the state of the pitch, they shall refuse such request for rolling of the pitch.

9.1.3 Choice of rollers

If there is more than one roller available the captain of the batting side shall choose which one is to be used.

The following shall apply in addition to clause 9.1:

9.1.4 Prior to the scheduled time for the toss, the artificial drying of the pitch and outfield shall be at the discretion of the Ground Authority. Thereafter and throughout the match the drying of the outfield may be undertaken at any time by the Ground Authority, but the drying of the affected area of the pitch shall be carried out only on the instructions and under the supervision of the umpires. The umpires shall be empowered to have the pitch dried without reference to the captains at any time they are of the opinion that it is unfit for play.**9.1.5 The umpires may instruct the Ground Authority to use any available equipment, including any roller for the purpose of drying the pitch and making it fit for play.****9.1.6 An absorbent roller may be used to remove water from the covers including the cover on the match pitch.****9.2 Clearing debris from the pitch****9.2.1 The pitch shall be cleared of any debris****9.2.1.1 between innings. This shall precede rolling if any is to take place.****9.2.1.2 at all intervals for meals.****9.2.2 The clearance of debris in clause 9.2.1 shall be done by sweeping, except where the umpires consider that this may be detrimental to the surface of the pitch. In this case the debris must be cleared from that area by hand, without sweeping.****9.2.3 In addition to 9.2.1, debris may be cleared from the pitch by hand, without sweeping, before mowing and whenever either umpire considers it necessary.****9.3 Mowing****9.3.1 Responsibility for mowing****9.3.1.1 All mowings which are carried out before the match shall be the sole responsibility of the Ground Authority.****9.4 Watering the pitch**

The pitch shall not be watered during the match.

9.5 Re-marking creases

Creases shall be re-marked whenever either umpire considers it necessary.

9.6 Maintenance of footholes

The umpires shall ensure that the holes made by the bowlers and batsmen are cleaned out and dried whenever necessary to facilitate play.

The umpires shall allow, if necessary, the returfing of footholes made by the bowlers in their delivery strides, or the use of quick-setting fillings for the same purpose.

In addition, the umpires shall see that wherever possible and whenever it is considered necessary, action is taken during all intervals in play to do whatever is practicable to improve the bowler's footholes.

9.7 Securing of footholds and maintenance of pitch

During play, umpires shall allow the players to secure their footholds by the use of sawdust provided that no damage to the pitch is caused and that clause 41 (Unfair play) is not contravened.

9.8 Protection and preparation of adjacent pitches during matches

The protection (by way of an appropriate cover) and preparation of pitches which are adjacent to the match pitch will be permitted during the match subject to the following:

9.8.1 Such measures will only be possible if requested by the Ground Authority and approved by the umpires before the start of the match.**9.8.2 Approval should only be granted where such measures are unavoidable and will not compromise the safety of the players or their ability to execute their actions with complete freedom.**

- 9.8.3 The preparation work shall be carried out under the supervision of the fourth umpire.
- 9.8.4 The consent of the captains is not required but the umpires shall advise both captains and the ICC Match Referee before the start of the match on what has been agreed.

10 COVERING THE PITCH

10.1 Before the match

The use of covers before the match is the responsibility of the Ground Authority and may include full covering if required.

The pitch shall be entirely protected against rain up to the commencement of play.

However, the Ground Authority shall grant suitable facility to the captains to inspect the pitch before the nomination of their players and to the umpires to discharge their duties as laid down in clauses 2 (The umpires), 6 (The pitch), 7 (The creases), 8 (The wickets), and 9 (Preparation and maintenance of the playing area).

10.2 During the match

The pitch shall be entirely protected against rain up to the commencement of play, and for the duration of the period of the match.

The covers must totally protect the pitch and also the pitch surroundings, to a minimum of 5 metres either side of the pitch, and any worn or soft areas in the outfield.

The bowlers' run-ups shall be covered during inclement weather, in order to keep them dry, to a distance of at least 10 x 10 metres.

10.3 Removal of covers

All covers (including "hessian" or "scrim" covers used to protect the pitch against the sun) shall be removed not later than 2 ½ hours before the scheduled start of play provided it is not raining at the time, but the pitch will be covered again if rain falls prior to the commencement of play.

11 INTERVALS

11.1 An interval

- 11.1.1 The following shall be classed as intervals.
- Intervals between innings.
 - Intervals for meals.
 - Intervals for drinks.
 - Any other agreed interval.
- 11.1.2 Only these intervals shall be considered as scheduled breaks for the purposes of clause 24.2.6.

11.2 Duration of interval

- 11.2.1 Except in circumstances provided for in clause 11.2.2 below. There shall be a 30 minute interval between innings, taken from the call of Time before the interval until the call of Play on resumption after the interval.
- 11.2.2 Home Boards may adjust the length of the interval between innings to suit their own requirements, provided that the scheduled length of the interval in an uninterrupted match is a minimum of 30 minutes and a maximum of 45 minutes.

11.3 Allowance for interval between innings

Law 11.3 of the Laws of Cricket shall not apply.

11.4 Changing agreed times of intervals

- 11.4.1 If the innings of the team batting first is completed prior to the scheduled time for the interval, the interval shall take place immediately and the innings of the team batting second will commence interval.

Note: The prescribed interval timings above may be reduced by the ICC Match Referee taking into account the intention of not having a prolonged interval after a lengthy interruption close to the conclusion of the innings of the team batting first. However, the minimum interval shall not be less than 10 minutes.

11.5 Intervals for drinks

- 11.5.1 Two drinks breaks per session shall be permitted, each 1 hour 10 minutes apart. Under conditions of extreme heat the umpires may permit extra intervals for drinks.
- 11.5.2 An individual player may be given a drink either on the boundary edge or at the fall of a wicket, on the field, provided that no playing time is wasted. No other drinks shall be taken onto the field without the permission of the umpires. Any player taking drinks onto the field shall be dressed in proper cricket attire (subject to the wearing of bibs – refer to the note in clause 24.1.4).

11.6 Scorers to be informed

The umpires shall ensure that the scorers are informed of all agreements about hours of play and intervals and of any changes made thereto as permitted under this clause.

12 START OF PLAY; CESSATION OF PLAY

12.1 Call of Play

The bowler's end umpire shall call Play before the first ball of the match and on the resumption of play after any interval or interruption.

12.2 Call of Time

The bowler's end umpire shall call Time, when the ball is dead, at the end of any session of play or as required by these Playing Conditions. See also clause 20.3 (Call of Over or Time).

12.3 Removal of bails

After the call of Time, the bails shall be removed from both wickets.

12.4 Starting a new over

Another over shall always be started at any time during the match, unless an interval is to be taken in the circumstances set out in clause 12.5.2, if the umpire, walking at normal pace, has arrived at the position behind the stumps at the bowler's end before the time agreed for the next interval has been reached.

12.5 Completion of an over

Other than at the end of the match,

12.5.1 if the agreed time for an interval is reached during an over, the over shall be completed before the interval is taken, except as provided for in clause 12.5.2.

12.5.2 when less than 3 minutes remains before the time agreed for the next interval, the interval shall be taken immediately if either a batsman is dismissed or retires or the players have occasion to leave the field whether this occurs during an over or at the end of an over. Except at the end of an innings, if an over is thus interrupted it shall be completed on the resumption of play.

12.6 Conclusion of match

12.6.1 The match is concluded

12.6.1.1 as soon as a result as defined in clauses 16.1 to 16.5 (The result) is reached.

12.6.1.2 as soon as the prescribed number of overs have been completed.

12.6.2 The match is concluded if, without a conclusion having been reached under 12.6.1, the players leave the field for adverse conditions of ground, weather or light, or in exceptional circumstances, and no further play is possible.

12.7 Hours of Play; Minimum Overs Requirement

12.7.1 To be determined by the Home Board subject to there being 2 sessions of 3.5 hours each, separated by a 45 minute interval between innings.

Note: The playing hours of matches scheduled to take place at venues where dew is likely to be a factor should be determined so as to ensure that the effect of any dew is minimised.

12.8 Minimum Over Rates

12.8.1 The minimum over rate to be achieved in ODI Matches shall be 14.28 overs per hour.

12.8.2 The actual over rate shall be calculated at the end of each innings by the umpires.

12.8.3 In calculating the actual over rate for the match, allowances will be given as follows:

12.8.3.1 The time lost as a result of treatment given to a player by an authorised medical personnel on the field of play;

12.8.3.2 The time lost as a result of a player being required to leave the field as a result of a serious injury;

12.8.3.3 The time taken for all third umpire referrals and consultations and any umpire or player reviews;

12.8.3.4 The time lost as a result of time wasting by the batting side; and

12.8.3.5 The time lost due to all other circumstances that are beyond the control of the fielding side.

12.8.4 In the event of any time allowances being granted to the fielding team under clause 12.8.3.4 above (time wasting by batting team), then such time shall be deducted from the allowances granted to such batting team in the determination of its over rate.

12.8.5 If a batting team is bowled out within the time determined for that innings pursuant to these playing conditions (taking into account all of the time allowances set out above), the fielding side shall be deemed to have complied with the required minimum over rate.

12.8.6 The current over rate of the fielding team (+/- overs compared to the minimum rate required), to be advised by the 3rd umpire every 30 minutes as a minimum, shall be displayed on a scoreboard or replay screen.

13 INNINGS**13.1 Number of innings**

13.1.1 A match shall be one innings for each side.

13.2 Alternate innings

Each side shall take their innings alternately.

13.3 Completed innings

A side's innings is to be considered as completed if any of the following applies:

13.3.1 the side is all out.

13.3.2 at the fall of a wicket or the retirement of a batsman, further balls remain to be bowled but no further batsman is available to come in.

13.3.3 the prescribed number of overs have been bowled to the batting side.

13.4 The toss

The captains shall toss a coin for the choice of innings, on the field of play and under the supervision of the ICC Match Referee, not earlier than 30 minutes, nor later than 15 minutes before the scheduled or any rescheduled time for the start of play. Note, however, the provisions of clause 1.3 (Captain).

13.5 Decision to be notified

As soon as the toss is completed, the captain of the side winning the toss shall decide whether to bat or to field and shall notify the opposing captain and the umpires of this decision. Once notified, the decision cannot be changed.

13.6 Duration of Match

- 13.6.1 All matches will consist of one innings per side, each innings being limited to a maximum of 50 overs. All matches shall be of one day's scheduled duration provided that participating countries in a series may agree to provide for a reserve day on which an incomplete match may be replayed or continued from the scheduled day.
- 13.6.2 If the match is to be continued on the reserve day, every effort shall be made to complete the match on the scheduled day with any necessary reduction in overs taking place and only if the minimum number of overs necessary to constitute a match cannot be bowled on the scheduled day will the match be completed on the reserve day.
- 13.6.3 If the match has started on the scheduled day and overs are subsequently reduced following an interruption, but no further play is possible, the match will resume on the reserve day under the same assumption that the last ball was played on the scheduled day. Refer to Appendix G.

13.7 Length of Innings

- 13.7.1 Uninterrupted Matches.
- 13.7.1.1 Each team shall bat for 50 overs unless all out earlier.
- 13.7.1.2 If the team fielding first fails to bowl the required number of overs by the scheduled time for cessation of the first innings, play shall continue until the required number of overs has been bowled. The interval shall be reduced to enable the second innings to commence at the scheduled time, subject to there being a minimum interval of 30 minutes. The team batting second shall receive its full quota of 50 overs irrespective of the number of overs it bowled in the scheduled time for the cessation of the first innings.
- 13.7.1.3 If the team batting first is dismissed in less than 50 overs, the team batting second shall be entitled to bat for 50 overs.

13.7.1.4 If the team fielding second fails to bowl 50 overs by the scheduled cessation time, the hours of play shall be extended until the required number of overs has been bowled or a result is achieved.

13.7.1.5 Penalties shall apply for slow over rates (refer to the ICC Code of Conduct).

13.7.2 Delayed or Interrupted Matches

13.7.2.1 Delay or Interruption to the Innings of the Team Batting First (see paragraph 1 of Appendix E)

13.7.2.1.1 When playing time has been lost the revised number of overs to be bowled in the match shall be based on a rate of 14.28 overs per hour, which is inclusive of the provision of drinks intervals, in the total remaining time available for play.

13.7.2.1.2 The revision of the number of overs should ensure, whenever possible, that both teams have the opportunity of batting for the same number of overs. The team batting second shall not bat for a greater number of overs than the first team unless the latter completed its innings in less than its allocated overs. To constitute a match, a minimum of 20 overs have to be bowled to the side batting second, subject to a result not being achieved earlier.

13.7.2.1.3 As soon as the total minutes of playing time remaining is less than the completed overs faced by Team 1 multiplied by 4.2, then the first innings is terminated and the provisions of 13.7.2.2 below take effect.

13.7.2.1.4 A fixed time will be specified for the commencement of the interval, and also the close of play for the match, by applying a rate of 14.28 overs per hour. When calculating the length of playing time available for the match, or the length of either innings, the timing and duration of all relative delays, extensions in playing hours, interruptions in play, and intervals, excluding those for drinks, will be taken into consideration. This calculation must not cause the match to finish earlier than the original or rescheduled time for cessation of play on the final scheduled day for play. If required the original time shall be extended to allow for one extra over for each team.

- 13.7.2.1.5 If the team fielding first fails to bowl the revised number of overs by the specified time, play shall continue until the required number of overs have been bowled or the innings is completed.
- 13.7.2.1.6 Penalties shall apply for slow over rates (refer to the ICC Code of Conduct).
- 13.7.2.2 Delay or Interruption to the innings of the Team Batting Second (see paragraph 2 of Appendix E)
- 13.7.2.2.1 When playing time has been lost and, as a result, it is not possible for the team batting second to have the opportunity of receiving its allocated, or revised allocation of overs in the playing time available, the number of overs shall be reduced at a rate of 14.28 overs per hour, which is inclusive of the provision of drinks intervals, in respect of the lost playing time. Should the calculations result in a fraction of an over the fraction shall be ignored.
- 13.7.2.2.2 In addition, should the innings of the team batting first have been completed prior to the scheduled, or re-scheduled time for the commencement of the interval, then any calculation relating to the revision of overs shall not be effective until an amount of time equivalent to that by which the second innings started early has elapsed.
- 13.7.2.2.3 To constitute a match, a minimum of 20 overs have to be bowled to the team batting second subject to a result not being achieved earlier.
- 13.7.2.2.4 The team batting second shall not bat for a greater number of overs than the first team unless the latter completed its innings in less than its allocated overs.
- 13.7.2.2.5 A fixed time will be specified for the close of play by applying a rate of 14.28 overs per hour. With the exception of drinks intervals, the timing and duration of all relative delays, extensions in playing hours and interruptions in play, will be taken into consideration in specifying this time.
- 13.7.2.2.6 If the team fielding second fails to bowl the revised overs by the scheduled or re-scheduled close of play, the hours of play shall be extended until the overs have been bowled or a result achieved.
- 13.7.2.2.7 Penalties shall apply for slow over rates (refer to the ICC Code of Conduct).

13.8 Extra Time

The participating countries may agree to provide for extra time where the start of play is delayed or play is suspended.

13.9 Number of Overs per Bowler

- 13.9.1 No bowler shall bowl more than 10 overs in an innings.
- 13.9.2 In a delayed or interrupted match where the overs are reduced for both teams or for the team bowling second, no bowler may bowl more than one-fifth of the total overs allowed.
- 13.9.3 Where the total overs is not divisible by 5, one additional over shall be allowed to the maximum number per bowler necessary to make up the balance.
- 13.9.4 In the event of a bowler breaking down and being unable to complete an over, the remaining balls will be allowed by another bowler. Such part of an over will count as a full over only in so far as each bowler's limit is concerned.
- 13.9.5 The scoreboard shall show the total number of overs bowled and the number of overs bowled by each bowler.

14 THE FOLLOW-ON

Shall not apply.

15 DECLARATION AND FORFEITURE

Shall not apply.

16 THE RESULT**16.1 A Win – one-innings match**

- 16.1.1 The side which has scored in its one innings a total of runs in excess of that scored by the opposing side in its one completed innings shall win the match. See clause 13.3 (Completed innings). Note also clause 16.5 (Winning hit or extras).
- 16.1.2 Save for circumstances where a match is awarded to a team as a consequence of the opposing team's refusal to play (clause 16.2), a result can be achieved only if both teams have had the opportunity of batting for at least 20 overs, unless one team has been all out in less than 20 overs or unless the team batting second scores enough runs to win in less than 20 overs.
- 16.1.3 Save for circumstances where a match is awarded to a team as a consequence of the opposing team's refusal to play (clause 16.2), all matches in which both teams have not had an opportunity of batting for a minimum of 20 overs, shall be declared a No Result.

16.2 ICC Match Referee awarding a match

- 16.2.1 A match shall be lost by a side which either
- 16.2.1.1 concedes defeat or
- 16.2.1.2 in the opinion of the ICC Match Referee refuses to play and the ICC Match Referee shall award the match to the other side.

16.2.2 If an umpire considers that an action by any player or players might constitute a refusal by either side to play then the umpires together shall inform the ICC Match Referee of this fact. The ICC Match Referee shall together with the umpires ascertain the cause of the action. If the ICC Match Referee, after due consultation with the umpires, then decides that this action does constitute a refusal to play by one side, he/she shall so inform the captain of that side. If the captain persists in the action the ICC Match Referee shall award the match in accordance with clause 16.2.1.2 above.

16.2.3 If action as in clause 16.2.2 above takes place after play has started and does not constitute a refusal to play the delay or interruption in play shall be dealt with in the same manner as provided for in clauses 13.7.2 (Delayed and Interrupted Matches) and 11.4 (Changing agreed times for intervals) above.

Note: In addition to the consequences of any refusal to play prescribed under this clause, any such refusal, whether temporary or final, may result in disciplinary action being taken against the captain and team responsible under the ICC Code of Conduct.

16.3 All other matches – A Tie or No Result

16.3.1 A Tie

The result of a match shall be a Tie when all innings have been completed and the scores are equal.

If the scores are equal, the result shall be a tie and no account shall be taken of the number of wickets that have fallen.

16.3.2 No Result

See 16.1.3 above.

16.4 Prematurely Terminated Matches - Calculation of the Target Score

16.4.1 Interrupted Matches – Calculation of the Target Score

16.4.1.1 If, due to suspension of play after the start of the match, the number of overs in the innings of either team has to be revised to a lesser number than originally allotted (minimum of 20 overs), then a revised target score (to win) should be set for the number of overs which the team batting second will have the opportunity of facing. This revised target is to be calculated using the current Duckworth/Lewis/Stern method. The target set will always be a whole number and one run less will constitute a Tie (refer to the Duckworth/Lewis/Stern Regulations).

16.4.2 Prematurely Terminated Matches

16.4.2.1 If the innings of the side batting second is suspended (with at least 20 overs bowled) and it is not possible for the match to be resumed, the match will be decided by comparison with the DLS 'Par Score' determined at the instant of the suspension by the Duckworth/Lewis/Stern method (refer Duckworth/Lewis/Stern Regulations). If the score is equal to the par score, the match is a Tie. Otherwise the result is a victory, or defeat, by the margin of runs by which the score exceeds, or falls short of, the Par Score.

16.5 Winning hit or extras

16.5.1 As soon as a result is reached as defined in clauses 16.1, 16.2 or 16.3.1, the match is at an end. Nothing that happens thereafter, except as in clause 41.18.2 (Penalty runs), shall be regarded as part of it. Note also clause 16.8.

16.5.2 The side batting last will have scored enough runs to win only if its total of runs is sufficient without including any runs completed by the batsmen before the completion of a catch, or the obstruction of a catch, from which the striker could be dismissed.

16.5.3 If a boundary is scored before the batsmen have completed sufficient runs to win the match, the whole of the boundary allowance shall be credited to the side's total and, in the case of a hit by the bat, to the striker's score.

16.6 Statement of result

If the side batting last wins the match without losing all its wickets, the result shall be stated as a win by the number of wickets still then to fall.

If, without having scored a total of runs in excess of the total scored by the opposing side, the innings of the side batting last has been completed, but as the result of an award of 5 Penalty runs its total of runs is then sufficient to win, the result shall be stated as a win to that side by Penalty runs.

If the side fielding last wins the match, the result shall be stated as a win by runs.

If the match is decided by one side conceding defeat or refusing to play, the result shall be stated as Match Conceded or Match Awarded, as the case may be.

16.7 Correctness of result

Any decision as to the correctness of the scores shall be the responsibility of the umpires. See clause 2.15 (Correctness of scores).

16.8 Mistakes in scoring

If, after the players and umpires have left the field in the belief that the match has been concluded, the umpires discover that a mistake in scoring has occurred which affects the result then, subject to clause 16.9, they shall adopt the following procedure.

- 16.8.1 If, when the players leave the field, the side batting last has not completed its innings and either the number of overs to be bowled in that innings has not been completed, or the end of the innings has not been reached, then, unless one side concedes defeat, the umpires shall order play to resume.
- Unless a result is reached sooner, play will then continue, if conditions permit, until the prescribed number of overs has been completed. The number of overs shall be taken as they were at the call of Time for the supposed conclusion of the match. No account shall be taken of the time between that moment and the resumption of play.
- 16.8.2 If, at this call of Time, the overs have been completed and no Playing time remains, or if the side batting last has completed its innings, the umpires shall immediately inform both captains of the necessary corrections to the scores and to the result.

16.9 Result not to be changed

Once the umpires have agreed with the scorers the correctness of the scores at the conclusion of the match – see clauses 2.15 (Correctness of scores) and 3.2 (Correctness of scores) – the result cannot thereafter be changed.

16.10 Points

16.10.1 Preliminary Matches

In a competition with three or four Members with ODI status and with a final match or series, the home Board will institute a points system as follows:

Win	2
Tie, No Result or Abandoned	1
Loss	0

In the event of teams finishing on equal points, the right to play in the final match or series will be determined as follows:

- The team with the most number of wins
- If still equal, the team with the most number of wins over the other team(s) who are equal on points and have the same number of wins
- If still equal, the team with the highest number of bonus points
- If still equal, the team with the highest net run rate

In a match declared as a No Result, run rate is not applicable.

16.10.2 Net Run Rate

A team's net run rate is calculated by deducting from the average runs per over scored by that team throughout the competition, the average runs per over scored against that team throughout the competition.

In the event of a team being all out in less than its full quota of overs, the calculation of its net run rate shall be based on the full quota of overs to which it would have been entitled and not on the number of overs in which the team was dismissed.

Only those matches where results are achieved will count for the purpose of net run rate calculations. Where a match is abandoned, but a result is achieved under Duckworth/Lewis/Stern, for net run rate purposes Team 1 will be credited with Team 2's Par Score on abandonment off the same number of overs faced by Team 2. Where a match is concluded with Duckworth/Lewis/Stern having been applied at an earlier point in the match, Team 1 will be credited with 1 run less than the final Target Score for Team 2 off the total number of overs allocated to Team 2 to reach the target.

16.10.3 Bonus Points

The team that achieves a run rate of 1.25 times that of the opposition shall be awarded one bonus point. A team's run rate will be calculated by reference to the runs scored in an innings divided by the number of overs faced. Refer to Appendix F.

17 THE OVER

17.1 Number of balls

The ball shall be bowled from each end alternately in overs of 6 balls.

17.2 Start of an over

An over has started when the bowler starts his run-up or, if there is no run-up, starts his action for the first delivery of that over.

17.3 Validity of balls

- 17.3.1 A ball shall not count as one of the 6 balls of the over unless it is delivered, even though, as in clause 41.16 (Non-striker leaving his ground early) a batsman may be dismissed or some other incident occurs without the ball having been delivered.
- 17.3.2 A ball delivered by the bowler shall not count as one of the 6 balls of the over:
- 17.3.2.1 if it is called dead, or is to be considered dead, before the striker has had an opportunity to play it. See clause 20.6 (Dead ball; ball counting as one of over).
 - 17.3.2.2 if it is called dead in the circumstances of clause 20.4.2.6. Note also the special provisions of clause 20.4.2.5 (Umpire calling and signaling Dead ball)
 - 17.3.2.3 if it is a No ball. See clause 21 (No ball).
 - 17.3.2.4 if it is a Wide. See clause 22 (Wide ball).

17.3.2.5 when any of clauses 24.4 (Player returning without permission), 28.2 (Fielding the ball), 41.4 (Deliberate attempt to distract striker), or 41.5 (Deliberate distraction, deception or obstruction of batsman) is applied.

17.3.3 Any deliveries other than those listed in clauses 17.3.1 and 17.3.2 shall be known as valid balls. Only valid balls shall count towards the 6 balls of the over.

17.4 Call of Over

When 6 valid balls have been bowled and when the ball becomes dead, the umpire shall call Over before leaving the wicket. See also clause 20.3 (Call of Over or Time).

17.5 Umpire miscounting

17.5.1 If the umpire miscounts the number of valid balls, the over as counted by the umpire shall stand.

17.5.2 If, having miscounted, the umpire allows an over to continue after 6 valid balls have been bowled, he/she may subsequently call Over when the ball becomes dead after any delivery, even if that delivery is not a valid ball.

17.5.3 Whenever possible, the third umpire shall liaise with the scorers and if possible inform the on-field umpires if the over has been miscounted.

17.6 Bowler changing ends

A bowler shall be allowed to change ends as often as desired, provided he does not bowl two overs consecutively, nor bowl parts of each of two consecutive overs, in the same innings.

17.7 Finishing an over

17.7.1 Other than at the end of an innings, a bowler shall finish an over in progress unless incapacitated or suspended under these Playing Conditions.

17.7.2 If for any reason, other than the end of an innings, an over is left uncompleted at the start of an interval or interruption, it shall be completed on resumption of play.

17.8 Bowler incapacitated or suspended during an over

If for any reason a bowler is incapacitated while running up to deliver the first ball of an over, or is incapacitated or suspended during an over, the umpire shall call and signal Dead ball. Another bowler shall complete the over from the same end, provided that he does not bowl two overs consecutively, nor bowl parts of each of two consecutive overs, in that innings.

18 SCORING RUNS

18.1 A run

The score shall be reckoned by runs. A run is scored:

18.1.1 so often as the batsmen, at any time while the ball is in play, have crossed and made good their ground from end to end.

18.1.2 when a boundary is scored. See clause 19 (Boundaries).

18.1.3 when Penalty runs are awarded. See clause 18.6.

18.2 Runs disallowed

Wherever in these Playing Conditions provision is made for the scoring of runs or awarding of penalties, such runs and penalties will be subject to any provisions that may be applicable for the disallowance of runs or for the non-award of penalties.

When runs are disallowed, the one run penalty for No ball or Wide shall stand and 5 run penalties shall be allowed, except for Penalty runs under clause 28.3 (Protective helmets belonging to the fielding side).

18.3 Short runs

18.3.1 A run is short if a batsman fails to make good his ground in turning for a further run.

18.3.2 Although a short run shortens the succeeding one, the latter if completed shall not be regarded as short. A striker setting off for the first run from in front of the popping crease may do so also without penalty.

18.4 Unintentional short runs

Except in the circumstances of clause 18.5,

18.4.1 if either batsman runs a short run, the umpire concerned shall, unless a boundary is scored, call and signal Short run as soon as the ball becomes dead and that run shall not be scored.

18.4.2 if, after either or both batsmen run short, a boundary is scored the umpire concerned shall disregard the short running and shall not call or signal Short run.

18.4.3 if both batsmen run short in one and the same run, this shall be regarded as only one short run.

18.4.4 if more than one run is short then, subject to clauses 18.4.2 and 18.4.3, all runs called as short shall not be scored.

18.4.5 if there has been more than one short run, the umpire shall inform the scorers as to the number of runs to be recorded.

18.5 Deliberate short runs

18.5.1 If either umpire considers that one or both batsmen deliberately ran short at that umpire's end, the umpire concerned shall, when the ball is dead, call and signal Short run and inform the other umpire of what has occurred and apply clause 18.5.2.

- 18.5.2 The bowler's end umpire shall
- disallow all runs to the batting side
 - return any not out batsman to his original end
 - signal No ball or Wide to the scorers, if applicable
 - award 5 Penalty runs to the fielding side
 - award any other 5-run Penalty that is applicable except for Penalty runs under clause 28.3 (Protective helmets belonging to the fielding side)
 - inform the scorers as to the number of runs to be recorded, and
 - inform the captain of the fielding side and, as soon as practicable, the captain of the batting side of the reason for this action.

18.6 Runs awarded for penalties

Runs shall be awarded for penalties under clauses 18.5 (Deliberate short runs), 21 (No ball), 22 (Wide ball), 24.4 (Player returning without permission), 26.4 (Penalties for contravention), 28.2 (Fielding the ball), 28.3 (Protective helmets belonging to the fielding side) 41 (Unfair play) and 42 (Players' conduct). Note, however, the restrictions on the award of Penalty runs in clauses 23.3 (Leg byes not to be awarded), 28.3 (Protective helmets belonging to the fielding side) and 34 (Hit the ball twice).

18.7 Runs scored for boundaries

Runs shall be scored for boundary allowances under clause 19 (Boundaries).

18.8 Runs scored when a batsman is dismissed

When a batsman is dismissed, any runs for penalties awarded to either side shall stand.

No other runs shall be credited to the batting side, except as follows.

- 18.8.1 If a batsman is dismissed Obstructing the field, the batting side shall also score any runs completed before the offence.
- If, however, the obstruction prevented a catch being made, no runs other than penalties shall be scored.
- 18.8.2 If a batsman is dismissed Run out, the batting side shall also score any runs completed before the wicket was put down.

18.9 Runs scored when the ball becomes dead other than at the fall of a wicket

When the ball becomes dead for any reason other than the fall of a wicket, or is called dead by an umpire, unless there is specific provision otherwise in these Playing Conditions, any runs for penalties awarded to either side shall be scored. Note however the provisions of clauses 23.3 (Leg byes not to be awarded) and 28.3 (Protective helmets belonging to the fielding side).

Additionally the batting side shall be credited with all runs completed by the batsmen before the incident or call of Dead ball and the run in progress if the batsmen had already crossed at the instant of the incident or call of Dead ball. Note specifically, however, the provisions of clause 41.5.8 (Deliberate distraction, deception or obstruction of batsman).

18.10 Crediting of runs scored

Unless stated otherwise in these Playing Conditions,

- 18.10.1 if the ball is struck by the bat, all runs scored by the batting side shall be credited to the striker, except for the following:
- an award of 5 Penalty runs, which shall be scored as Penalty runs
 - the one run penalty for a No ball, which shall be scored as a No ball extra
- 18.10.2 if the ball is not struck by the bat, runs shall be scored as Penalty runs, Byes, Leg byes, No ball extras or Wides as the case may be. If Byes or Leg byes accrue from a No ball, only the one run penalty for No ball shall be scored as such, and the remainder as Byes or Leg byes as appropriate.
- 18.10.3 the bowler shall be debited with:
- all runs scored by the striker
 - all runs scored as No ball extras
 - all runs scored as Wides

18.11 Batsman returning to original end

- 18.11.1 When the striker is dismissed in any of the circumstances in clauses 18.11.1.1 to 18.11.1.5, the not out batsman shall return to his original end.
- 18.11.1.1 Bowled.
- 18.11.1.2 Stumped.
- 18.11.1.3 Hit the ball twice.
- 18.11.1.4 LBW.
- 18.11.1.5 Hit wicket.
- 18.11.2 The batsmen shall return to their original ends in any of the cases of clauses 18.11.2.1 to 18.11.2.3.
- 18.11.2.1 A boundary is scored.
- 18.11.2.2 Runs are disallowed for any reason.
- 18.11.2.3 A decision by the batsmen at the wicket to do so, under clause 41.5 (Deliberate distraction, deception or obstruction of batsman).

18.12 Batsman returning to wicket he has left

- 18.12.1 When a batsman is dismissed in any of the ways in clauses 18.12.1.1 to 18.12.1.3, the not out batsman shall return to the wicket he has left but only if the batsmen had not already crossed at the instant of the incident causing the dismissal. If runs are to be disallowed, however, the not out batsman shall return to his original end.
- 18.12.1.1 Caught
- 18.12.1.2 Obstructing the field
- 18.12.1.3 Run out

- 18.12.2 If, while a run is in progress, the ball becomes dead for any reason other than the dismissal of a batsman, the batsmen shall return to the wickets they had left, but only if they had not already crossed in running when the ball became dead. If, however, any of the circumstances of clauses 18.11.2.1 to 18.11.2.3 apply, the batsmen shall return to their original ends.

19 BOUNDARIES

19.1 Determining the boundary of the field of play

- 19.1.1 Before the toss, the umpires shall determine the boundary of the field of play, which shall be fixed for the duration of the match. See clause 2.3.4 (Consultation with Home Board).
- 19.1.2 The boundary shall be determined such that no part of any sight-screen, will, at any stage of the match, be within the field of play.
- 19.1.3 The aim shall be to maximize the size of the playing area at each venue. With respect to the size of the boundaries, no boundary shall be longer than 90 yards (82.29 meters), and no boundary should be shorter than 65 yards (59.43 metres) from the centre of the pitch to be used.
- 19.1.4 At all times, there must be 3 yards (2.74 meters) from the boundary rope to the first solid object (advertising boards/LEDs, photographers, cameramen, dug outs, covers, perimeter fence) for the player's safety run off.
- 19.1.5 If the boundary is positioned less than 90 yards (82.29 meters) from the centre of the pitch, the boundary rope cannot be set at a distance of more than 10 yards (9.14 meters) from the perimeter fence. The 10 yards shall be inclusive of the 3 yards (2.74 meters) provided for the player's safety run off.
- 19.1.6 Any ground which has previously been approved to host international cricket which is unable to conform to the minimum boundary dimension shall be exempt. In such cases the boundary shall be positioned so as to maximize the size of the playing area.

19.2 Identifying and marking the boundary

- 19.2.1 All boundaries must be designated by a rope, or similar object of a minimum standard as authorised by the ICC from time to time.
- 19.2.2 If the boundary is marked by means of an object that is in contact with the ground the boundary will be the edge of the grounded part of the object which is nearest the pitch.
- 19.2.3 An obstacle within the field of play shall not be regarded as a boundary unless so determined by the umpires before the toss. See clause 2.3.4 (Consultation with Home Board).
- 19.2.4 If an unauthorized person enters the playing arena and handles the ball, the umpire at the bowler's end shall be the sole judge of whether the boundary allowance should be scored or the ball be treated as still in play or called dead ball if a batsman is liable to be out as a result of the unauthorized person handling the ball.

19.3 Restoring the boundary

If a solid object used to mark the boundary is disturbed for any reason, then:

- 19.3.1 the boundary shall be considered to be in its original position.
- 19.3.2 the object shall be returned to its original position as soon as is practicable; if play is taking place, this shall be as soon as the ball is dead.
- 19.3.3 if some part of a fence or other marker has come within the field of play, that part shall be removed from the field of play as soon as is practicable; if play is taking place, this shall be as soon as the ball is dead.

19.4 Ball grounded beyond the boundary

- 19.4.1 The ball in play is grounded beyond the boundary if it touches
- the boundary or any part of an object used to mark the boundary;
 - the ground beyond the boundary;
 - any object that is grounded beyond the boundary.
- 19.4.2 The ball in play is to be regarded as being grounded beyond the boundary if
- a fielder, grounded beyond the boundary as in clause 19.5, touches the ball;
 - a fielder, after catching the ball within the boundary, becomes grounded beyond the boundary while in contact with the ball, before completing the catch.

19.5 Fielder grounded beyond the boundary

- 19.5.1 A fielder is grounded beyond the boundary if some part of his person is in contact with any of the following:
- the boundary or any part of an object used to mark the boundary;
 - the ground beyond the boundary;
 - any object that is in contact with the ground beyond the boundary;
 - another fielder who is grounded beyond the boundary.
- 19.5.2 A fielder who is not in contact with the ground is considered to be grounded beyond the boundary if his final contact with the ground, before his first contact with the ball after it has been delivered by the bowler, was not entirely within the boundary.

19.6 Boundary allowances

- 19.6.1 6 runs shall be allowed for a boundary 6; and 4 runs for a boundary 4. See also clause 19.7.

19.7 Runs scored from boundaries

- 19.7.1 A boundary 6 will be scored if and only if the ball has been struck by the bat and is first grounded beyond the boundary without having been in contact with the ground within the field of play. This shall apply even if the ball has previously touched a fielder.
- 19.7.2 A boundary 4 will be scored when a ball that is grounded beyond the boundary:
- whether struck by the bat or not, was first grounded within the boundary, or
 - has not been struck by the bat.
- 19.7.3 When a boundary is scored, the batting side, except in the circumstances of clause 19.8, shall be awarded whichever is the greater of:
- 19.7.3.1 the allowance for the boundary
- 19.7.3.2 the runs completed by the batsmen together with the run in progress if they had already crossed at the instant the boundary is scored.
- 19.7.4 When the runs in clause 19.7.3.2 exceed the boundary allowance they shall replace the boundary allowance for the purposes of clause 18.12.2.
- 19.7.5 The scoring of Penalty runs by either side is not affected by the scoring of a boundary.

19.8 Overthrow or wilful act of fielder

If the boundary results from an overthrow or from the wilful act of a fielder, the runs scored shall be

any runs for penalties awarded to either side

and the allowance for the boundary

and the runs completed by the batsmen, together with the run in progress if they had already crossed at the instant of the throw or act.

Clause 18.12.2 (Batsman returning to wicket he has left) shall apply as from the instant of the throw or act.

20 DEAD BALL**20.1 Ball is dead**

- 20.1.1 The ball becomes dead when
- 20.1.1.1 it is finally settled in the hands of the wicket-keeper or of the bowler.
- 20.1.1.2 a boundary is scored. See clause 19.7 (Runs scored from boundaries).
- 20.1.1.3 a batsman is dismissed. The ball will be deemed to be dead from the instant of the incident causing the dismissal.

- 20.1.1.4 whether played or not it becomes trapped between the bat and person of a batsman or between items of his clothing or equipment.
- 20.1.1.5 whether played or not it lodges in the clothing or equipment of a batsman or the clothing of an umpire.
- 20.1.1.6 there is an award of Penalty runs under either of clauses 24.4 (Player returning without permission) or 28.3 (Fielding the ball). The ball shall not count as one of the over.
- 20.1.1.7 there is a contravention of clause 28.3 (Protective helmets belonging to the fielding side).
- 20.1.1.8 the match is concluded in any of the ways stated in clause 12.6 (Conclusion of match).
- 20.1.2 The ball shall be considered to be dead when it is clear to the bowler's end umpire that the fielding side and both batsmen at the wicket have ceased to regard it as in play.
- 20.1.3 In a match where cameras are being used on or over the field of play (e.g. Spidercam), should a ball that has been hit by the batsman make contact, while still in play, with the camera, its apparatus or its cable, either umpire shall call and signal 'dead ball'. The ball shall not count as one of the over and no runs shall be scored. If the delivery was called a No ball it shall count and the No ball penalty shall be applied. No other runs (including penalty runs) apart from the No ball penalty shall be scored.
- 20.1.4 Should a ball thrown by a fielder make contact with a camera on or over the field of play, its apparatus or its cable, either umpire shall call and signal dead ball. Unless this was already a No ball or Wide, the ball shall count as one of the over. All runs scored to that point shall count, plus the run in progress if the batsmen have already crossed.
- 20.1.5 Refer also to paragraph 2.6 of Appendix D.

20.2 Ball finally settled

Whether the ball is finally settled or not is a matter for the umpire alone to decide.

20.3 Call of Over or Time

Neither the call of Over (see clause 17.4), nor the call of Time (see clause 12.2) is to be made until the ball is dead, either under clauses 20.1 or 20.4.

20.4 Umpire calling and signalling Dead ball

- 20.4.1 When the ball has become dead under clause 20.1, the bowler's end umpire may call and signal Dead ball if it is necessary to inform the players.
- 20.4.2 Either umpire shall call and signal Dead ball when
- 20.4.2.1 intervening in a case of unfair play.
- 20.4.2.2 a possibly serious injury to a player or umpire occurs.
- 20.4.2.3 leaving his/her normal position for consultation.

- 20.4.2.4 one or both bails fall from the striker's wicket before the striker has had the opportunity of playing the ball.
- 20.4.2.5 the striker is not ready for the delivery of the ball and, if the ball is delivered, makes no attempt to play it. Provided the umpire is satisfied that the striker had adequate reason for not being ready, the ball shall not count as one of the over.
- 20.4.2.6 the striker is distracted by any noise or movement or in any other way while preparing to receive, or receiving a delivery. This shall apply whether the source of the distraction is within the match or outside it. Note also clause 20.4.2.7. The ball shall not count as one of the over.
- 20.4.2.7 there is an instance of a deliberate attempt to distract under either of clauses 41.4 (Deliberate attempt to distract striker) or 41.5 (Deliberate distraction, deception or obstruction of batsman). The ball shall not count as one of the over.
- 20.4.2.8 the bowler drops the ball accidentally before delivery.
- 20.4.2.9 the ball does not leave the bowler's hand for any reason other than an attempt to run out the non-striker under clause 41.16 (Non-striker leaving his ground early).
- 20.4.2.10 satisfied that the ball in play cannot be recovered.
- 20.4.2.11 required to do so under any of the Playing Conditions not included above.

20.5 Ball ceases to be dead

The ball ceases to be dead – that is, it comes into play – when the bowler starts his run-up or, if there is no run-up, starts his bowling action.

20.6 Dead ball; ball counting as one of over

- 20.6.1 When a ball which has been delivered is called dead or is to be considered dead then, other than as in clause 20.6.2,
- 20.6.1.1 it will not count in the over if the striker has not had an opportunity to play it.
- 20.6.1.2 Unless No ball or Wide ball has been called, it will be a valid ball if the striker has had an opportunity to play it, except in the circumstances of clauses 20.4.2.6 and 24.4 (Player returning without permission), 28.2 (Fielding the ball), 41.4 (Deliberate attempt to distract striker) and 41.5 (Deliberate distraction, deception or obstruction of batsman).
- 20.6.2 In clause 20.4.2.5, the ball will not count in the over only if both conditions of not attempting to play the ball and having an adequate reason for not being ready are met. Otherwise the delivery will be a valid ball.

21 NO BALL

21.1 Mode of delivery

- 21.1.1 The umpire shall ascertain whether the bowler intends to bowl right handed or left handed, over or round the wicket, and shall so inform the striker.

It is unfair if the bowler fails to notify the umpire of a change in his mode of delivery. In this case the umpire shall call and signal No ball.

- 21.1.2 Underarm bowling shall not be permitted.

21.2 Fair delivery – the arm

For a delivery to be fair in respect of the arm the ball must not be delivered with an Illegal Bowling Action.

An Illegal Bowling Action is defined as a bowling action where a bowler's Elbow Extension exceeds 15 degrees, measured from the point at which the bowling arm reaches the horizontal until the point at which the ball is released (any Elbow Hyperextension shall be discounted for the purposes of determining an Illegal Bowling Action).

Should either umpire or the ICC Match Referee suspect that a bowler has used an Illegal Bowling Action, they shall complete the ICC Bowling Action Report Form at the conclusion of the match, as set out in the Illegal Bowling Regulations.

21.3 Ball thrown or delivered underarm – action by umpires

- 21.3.1 If, in the opinion of either umpire, the ball has been thrown (where such mode of delivery does not correspond to the bowler's normal bowling action) or delivered underarm, he/she shall call and signal No ball and, when the ball is dead, inform the other umpire of the reason for the call.

The bowler's end umpire shall then

- warn the bowler, indicating that this is a first and final warning. This warning shall apply to that bowler throughout the innings.
- inform the captain of the fielding side of the reason for this action.
- inform the batsmen at the wicket of what has occurred.

- 21.3.2 If either umpire considers that, in that innings, a further delivery by the same bowler is thrown (where such mode of delivery does not correspond to the bowler's normal bowling action) or delivered underarm, he/she shall call and signal No ball and when the ball is dead inform the other umpire of the reason for the call.

The bowler's end umpire shall then

- direct the captain of the fielding side to suspend the bowler immediately from bowling. The over shall, if applicable, be completed by another bowler, who shall neither have bowled the previous over or part thereof nor be allowed to bowl any part of the next over. The bowler thus suspended shall not bowl again in that innings.

- inform the batsmen at the wicket and, as soon as practicable, the captain of the batting side of the reason for this action.

21.3.3 The umpires together shall report the occurrence as soon as possible after the match to the ICC Match Referee, who shall take such action as is considered appropriate against the bowler concerned.

21.4 Bowler throwing towards striker's end before delivery

If the bowler throws the ball towards the striker's end before entering the delivery stride, either umpire shall call and signal No ball. See clause 41.17 (Batsmen stealing a run).

However, the procedure stated in clause 21.3 of caution, informing, final warning, action against the bowler and reporting shall not apply.

21.5 Fair delivery – the feet

For a delivery to be fair in respect of the feet, in the delivery stride

- 21.5.1 the bowler's back foot must land within and not touching the return crease appertaining to his stated mode of delivery.
- 21.5.2 the bowler's front foot must land with some part of the foot, whether grounded or raised:
- on the same side of the imaginary line joining the two middle stumps as the return crease described in clause 21.5.1, and
 - behind the popping crease.

If the bowler's end umpire is satisfied that any of these three conditions have not been met, he/she shall call and signal No ball. See clause 41.8 (Bowling of deliberate front foot No ball).

21.6 Bowler breaking wicket in delivering ball

Either umpire shall call and signal No ball if, other than in an attempt to run out the non-striker under clause 41.16, the bowler breaks the wicket at any time after the ball comes into play and before completion of the stride after the delivery stride. This shall include any clothing or other object that falls from his person and breaks the wicket.

21.7 Ball bouncing more than once, rolling along the ground or pitching off the pitch

The umpire shall call and signal No ball if a ball which he/she considers to have been delivered, without having previously touched bat or person of the striker,

- bounces more than once
- or rolls along the ground before it reaches the popping crease
- or pitches wholly or partially off the pitch as defined in clause 6.1 (Area of pitch) before it reaches the line of the striker's wicket.

21.8 Ball coming to rest in front of striker's wicket

If a ball delivered by the bowler comes to rest in front of the line of the striker's wicket, without having previously touched the bat or person of the striker, the umpire shall call and signal No ball and immediately call and signal Dead ball.

21.9 Fielder intercepting a delivery

If except in the circumstances of clause 27.3 (Position of wicket-keeper) a ball, delivered by the bowler, makes contact with any part of a fielder's person before it either makes contact with the striker's bat or person, or it passes the striker's wicket, the umpire shall call and signal No ball and immediately call and signal Dead ball.

21.10 Ball bouncing over head height of striker

See clauses 22.1.1.2 and 41.6.1.7.

21.11 Call of No ball for infringement of other clauses

In addition to the instances above, No ball is to be called and signalled as required by the following:

Clause 27.3 – Position of wicket-keeper

Clause 28.4 – Limitation of on side fielders

Clause 28.5 – Fielders not to encroach on pitch

Clause 41.6 – Bowling of dangerous and unfair short pitched deliveries

Clause 41.7 – Bowling of dangerous and unfair non-pitching deliveries

Clause 41.8 – Bowling of deliberate front foot No ball

21.12 Revoking a call of No ball

An umpire shall revoke the call of No ball if Dead ball is called under any of clauses 20.4.2.4 to 20.4.2.9 (Umpire calling and signaling Dead ball). However, if a no ball is called in breach of clause 20.4.2.7 (41.4 - Deliberate attempt to distract striker before playing the ball or 41.5 - Deliberate attempt of Distraction, Deception or Obstruction of striker after the stroke) the No ball will stand.

21.13 No ball to over-ride Wide

A call of No ball shall over-ride the call of Wide ball at any time. See clauses 22.1 (Judging a Wide) and 22.2 (Call and signal of Wide ball).

21.14 Ball not dead

The ball does not become dead on the call of No ball.

21.15 Penalty for a No ball

A penalty of one run shall be awarded instantly on the call of No ball. Unless the call is revoked, the penalty shall stand even if a batsman is dismissed. It shall be in addition to any other runs scored, any boundary allowance and any other runs awarded for penalties.

21.16 Runs resulting from a No ball – how scored

The one run penalty shall be scored as a No ball extra and shall be debited against the bowler. If other Penalty runs have been awarded to either side these shall be scored as stated in clause 41.18 (Penalty runs). Any runs completed by the batsmen or any boundary allowance shall be credited to the striker if the ball has been struck by the bat; otherwise they shall also be scored as Byes or Leg byes as appropriate.

21.17 No ball not to count

A No ball shall not count as one of the over. See clause 17.3 (Validity of balls).

21.18 Out from a No ball

When No ball has been called, neither batsman shall be out under any of the Playing Conditions except clause 34 (Hit the ball twice), clause 37 (Obstructing the field) or clause 38 (Run out).

21.19 Free Hit

- 21.19.1 In addition to the above, the delivery following a No ball called (all modes of No ball) shall be a free hit for whichever batsman is facing it. If the delivery for the free hit is not a legitimate delivery (any kind of No ball or a Wide ball) then the next delivery will become a free hit for whichever batsman is facing it.
- 21.19.2 For any free hit, the striker can be dismissed only under the circumstances that apply for a No ball, even if the delivery for the free hit is called Wide.
- 21.19.3 Neither field changes nor the exchange of individuals between fielding positions are permitted for free hit deliveries unless:
- 21.19.3.1 There is a change of striker (the provisions of clause 41.2 shall apply), or
- 21.19.3.2 The No Ball was the result of a fielding restriction breach, in which case the field may be changed to the extent of correcting the breach.
- 21.19.4 For clarity, the bowler can change his mode of delivery for the free hit delivery. In such circumstances clause 21.1 shall apply.
- 21.19.5 The umpires will signal a free hit by (after the normal No Ball signal) extending one arm straight upwards and moving it in a circular motion.

22 WIDE BALL**22.1 Judging a Wide**

- 22.1.1 If the bowler bowls a ball, not being a No ball, the umpire shall adjudge it a Wide if, according to the definition in clause 22.1.2:
- 22.1.1.1 the ball passes wide of where the striker is standing and which also would have passed wide of the striker standing in a normal guard position.
- 22.1.1.2 the ball passes above the head height of the striker standing upright at the popping crease.

22.1.2 The ball will be considered as passing wide of the striker unless it is sufficiently within reach for him to be able to hit it with the bat by means of a normal cricket stroke.

22.1.3 Umpires are instructed to apply very strict and consistent interpretation in regard to this clause in order to prevent negative bowling wide of the wicket.

22.2 Call and signal of Wide ball

If the umpire adjudges a delivery to be a Wide he/she shall call and signal Wide ball as soon as the ball passes the striker's wicket. It shall, however, be considered to have been a Wide from the instant that the bowler entered his delivery stride, even though it cannot be called Wide until it passes the striker's wicket.

22.3 Revoking a call of Wide ball

- 22.3.1 The umpire shall revoke the call of Wide ball if there is then any contact between the ball and the striker's bat or person before the ball comes into contact with any fielder.
- 22.3.2 The umpire shall revoke the call of Wide ball if a delivery is called a No ball. See clause 21.13 (No ball to over-ride Wide).

22.4 Delivery not a Wide

- 22.4.1 The umpire shall not adjudge a delivery as being a Wide, if the striker, by moving, either causes the ball to pass wide of him, as defined in clause 22.1.2 or brings the ball sufficiently within reach to be able to hit it by means of a normal cricket stroke.
- 22.4.2 The umpire shall not adjudge a delivery as being a Wide if the ball touches the striker's bat or person, but only as the ball passes the striker.

22.5 Ball not dead

The ball does not become dead on the call of Wide ball.

22.6 Penalty for a Wide

A penalty of one run shall be awarded instantly on the call of Wide ball. Unless the call is revoked, see clause 22.3, this penalty shall stand even if a batsman is dismissed, and shall be in addition to any other runs scored, any boundary allowance and any other runs awarded for penalties.

22.7 Runs resulting from a Wide – how scored

All runs completed by the batsmen or a boundary allowance, together with the penalty for the Wide, shall be scored as Wide balls. Apart from any award of 5 Penalty runs, all runs resulting from a Wide shall be debited against the bowler.

22.8 Wide not to count

A Wide shall not count as one of the over. See clause 17.3 (Validity of balls).

22.9 Out from a Wide

When Wide ball has been called, neither batsman shall be out under any of the Playing Conditions except clause 35 (Hit wicket), clause 37 (Obstructing the field), clause 38 (Run out) or clause 39 (Stumped).

23 BYE AND LEG BYE**23.1 Byes**

If the ball, delivered by the bowler, not being a Wide, passes the striker without touching his bat or person, any runs completed by the batsmen from that delivery, or a boundary allowance, shall be credited as Byes to the batting side. Additionally, if the delivery is a No ball, the one run penalty for such a delivery shall be incurred.

23.2 Leg byes

23.2.1 If a ball delivered by the bowler first strikes the person of the striker, runs shall be scored only if the umpire is satisfied that the striker has:

either attempted to play the ball with the bat
or tried to avoid being hit by the ball.

23.2.2 If the umpire is satisfied that either of these conditions has been met runs shall be scored as follows.

23.2.2.1 If there is

either no subsequent contact with the striker's bat or person, or

only inadvertent contact with the striker's bat or person
any runs completed by the batsmen or a boundary allowance shall be credited to the striker in the case of subsequent contact with his bat but otherwise to the batting side as in clause 23.2.3.

23.2.2.2 If the striker wilfully makes a lawful second strike, clause 34.3 (Ball lawfully struck more than once) and clause 34.4 (Runs permitted from ball lawfully struck more than once) shall apply.

23.2.3 The runs in clause 23.2.2.1, unless credited to the striker, shall be scored as Leg byes.

Additionally, if the delivery is a No ball, the one run penalty for the No ball shall be incurred.

23.3 Leg byes not to be awarded

If in the circumstance of clause 23.2.1 the umpire considers that neither of the conditions therein has been met, then Leg byes shall not be awarded.

If the ball does not become dead for any other reason, the umpire shall call and signal Dead ball as soon as the ball reaches the boundary or at the completion of the first run.

The umpire shall then:

- disallow all runs to the batting side;
- return any not out batsman to his original end;
- signal No ball to the scorers if applicable;
- award any 5-run Penalty that is applicable except for Penalty runs under clause 28.3 (Protective helmets belonging to the fielding side).

24 FIELDER'S ABSENCE; SUBSTITUTES**24.1 Substitute fielders**

24.1.1 The umpires shall allow a substitute fielder

24.1.1.1 if they are satisfied that a fielder has been injured or become ill and that this occurred during the match, or

24.1.1.2 for any other wholly acceptable reason.

In all other circumstances, a substitute is not allowed.

24.1.2 A substitute shall not bowl or act as captain but may act as wicket-keeper only with the consent of the umpires. Note, however, clause 42.4.1.

24.1.3 A nominated player may bowl or field even though a substitute has previously acted for him, subject to 24.2 and 24.3.

24.1.4 Squad members of the fielding or batting team who are not playing in the match and who are not acting as substitute fielders shall be required to wear a team training bib whilst on the playing area (including the area between the boundary and the perimeter fencing).

24.2 Fielder absent or leaving the field of play

24.2.1 A player going briefly outside the boundary while carrying out any duties as a fielder is not absent from the field of play nor, for the purposes of this clause, is he to be regarded as having left the field of play.

24.2.2 If a fielder fails to take the field at the start of play or at any later time, or leaves the field during play,

24.2.2.1 an umpire shall be informed of the reason for this absence.

24.2.2.2 he shall not thereafter come on to the field of play during a session of play without the consent of the umpire. See clause 24.4. The umpire shall give such consent as soon as it is practicable.

24.2.3 If a player is absent from the field for longer than 8 minutes, the following restrictions shall apply to their future participation in the match:

24.2.3.1 The player shall not be permitted to bowl in the match until he has either been able to field, or his team has subsequently been batting, for the total length of playing time for which the player was absent (hereafter referred to as Penalty time). A player's unexpired Penalty time shall be limited to a maximum of 120 minutes. If any unexpired Penalty time remains at the end of an innings, it is carried forward to the next and subsequent innings of the match.

24.2.3.2 The player shall not be permitted to bat in the match until his team's batting innings has been in progress for the length of playing time that is equal to the unexpired Penalty time carried forward from the previous innings. However, once his side has lost five wickets in its batting innings, he may bat immediately. If any unexpired penalty time remains at the end of that batting innings, it is carried forward to the next and subsequent innings of the match.

24.2.4 If the player leaves the field before having served all of his Penalty time, the balance is carried forward as unserved Penalty time.

24.2.5 On any occasion of absence, the amount of playing time for which the player is off the field shall be added to any Penalty time that remains unserved, subject to a maximum cumulative Penalty time of 120 minutes, and that player shall not bowl until all of his Penalty time has been served.

24.2.6 For the purposes of clauses 24.2.3.1 and 24.2.3.2, playing time shall comprise the time play is in progress excluding intervals, intervals between innings and official drinks intervals. For clarity, a player's Penalty time will continue to expire after he is dismissed, for the remainder of his team's batting innings.

24.2.7 If there is an unscheduled break in play, the stoppage time shall count as Penalty time served, provided that,

24.2.7.1 the fielder who was on the field of play at the start of the break either takes the field on the resumption of play, or his side is now batting.

24.2.7.2 the fielder who was already off the field at the start of the break notifies an umpire in person as soon as he is able to participate, and either takes the field on the resumption of play, or his side is now batting. Stoppage time before an umpire has been so notified shall not count towards unserved Penalty time.

24.2.8 Any unserved Penalty time shall be carried forward into the next innings of the match, as applicable.

24.3 Penalty time not incurred

A nominated player's absence will not incur Penalty time if,

24.3.1 he has suffered an external blow during the match and, as a result, has justifiably left the field or is unable to take the field.

24.3.2 in the opinion of the umpires, the player has been absent or has left the field for other wholly acceptable reasons, which shall not include illness or internal injury.

24.3.3 the player is absent from the field for a period of 8 minutes or less.

24.4 Player returning without permission

If a player comes on to the field of play in contravention of clause 24.2.2 and comes into contact with the ball while it is in play, the ball shall immediately become dead.

- The umpire shall award 5 Penalty runs to the batting side.
- Runs completed by the batsmen shall be scored together with the run in progress if they had already crossed at the instant of the offence.
- The ball shall not count as one of the over.
- The umpire shall inform the other umpire, the captain of the fielding side, the batsmen and, as soon as practicable, the captain of the batting side of the reason for this action.

25 BATSMAN'S INNINGS

25.1 Eligibility to act as a batsman

Only a nominated player may bat and, subject to clause 25.3, may do so even though a substitute fielder has previously acted for him.

25.2 Commencement of a batsman's innings

The innings of the first two batsmen, and that of any new batsman on the resumption of play after a call of Time, shall commence at the call of Play. At any other time, a batsman's innings shall be considered to have commenced when that batsman first steps onto the field of play.

25.3 Restriction on batsman commencing an innings

25.3.1 If a member of the batting side has unserved Penalty time, see clause 24.2.7, that player shall not be permitted to bat until that Penalty time has been served. However, even if the unserved Penalty time has not expired, that player may bat after his side has lost 5 wickets.

25.3.2 A member of the batting side's Penalty time is served during Playing time, in the event of an unscheduled stoppage, the stoppage time after the batsman notifies an umpire in person that he is able to participate shall count as Penalty time served.

25.3.3 If any unserved Penalty time remains at the end of a team's innings, it shall be carried forward to the next innings of the match if appropriate.

25.4 Batsman retiring

25.4.1 A batsman may retire at any time during his innings when the ball is dead. The umpires, before allowing play to proceed, shall be informed of the reason for a batsman retiring.

25.4.2 If a batsman retires because of illness, injury or any other unavoidable cause, that batsman is entitled to resume his innings. If for any reason this does not happen, that batsman is to be recorded as 'Retired – not out'.

- 25.4.3 If a batsman retires for any reason other than as in clause 25.4.2, the innings of that batsman may be resumed only with the consent of the opposing captain. If for any reason his innings is not resumed, that batsman is to be recorded as 'Retired – out'.
- 25.4.4 If after retiring a batsman resumes his innings, subject to the requirements of clauses 25.4.2 and 25.4.3, it shall be only at the fall of a wicket or the retirement of another batsman.

25.5 Runners

Runners shall not be permitted.

26 PRACTICE ON THE FIELD

26.1 Practice on the pitch or the rest of the square

- 26.1.1 There shall not be any practice on the pitch at any time.
- 26.1.2 There shall not be any practice on the rest of the square at any time except with the approval of the umpires.
- 26.1.2.1 If approved by the umpires, the use of the square for practice on any day of any match will be restricted to any netted practice area or bowling strips specifically prepared on the edge of the square for that purpose.
- 26.1.2.2 Bowling practice on the bowling strips referred to above shall also be permitted during the interval (and change of innings if not the interval) unless the umpires consider that, in the prevailing conditions of ground and weather, it will be detrimental to the surface of the square.

26.2 Practice on the outfield

- 26.2.1 On any day of the match, all forms of practice are permitted on the outfield
- before the start of play
 - after the close of play, and
 - during the interval or between innings
- providing the umpires are satisfied that such practice will not cause significant deterioration in the condition of the outfield.
- 26.2.2 Between the call of Play and the call of Time, practice shall be permitted on the outfield, providing that all of the following conditions are met:
- only the fielders as defined in paragraph 7 of Appendix A participate in such practice.
 - no ball other than the match ball is used for this practice.
 - no bowling practice takes place in the area between the square and the boundary in a direction parallel to the match pitch.
 - the umpires are satisfied that it will not contravene either of clauses 41.3 (The match ball changing its condition) or 41.9 (Time wasting by the fielding side).
- Bowling a ball, using a short run up to a player in the outfield is not to be regarded as bowling practice but shall be subject to the other conditions in this clause.

26.3 Trial run-up

A bowler is permitted to have a trial run-up provided the umpire is satisfied that it will not contravene either of clauses 41.9 (Time wasting by the fielding side) or 41.12 (Fielder damaging the pitch).

26.4 Penalties for contravention

All forms of practice are subject to the provisions of clauses 41.3 (The match ball – changing its condition), 41.9 (Time wasting by the fielding side) and 41.12 (Fielder damaging the pitch).

- 26.4.1 If there is a contravention of any of the provisions of clause 26.1 or 26.2, the umpire shall:
- warn the player that the practice is not permitted;
 - inform the other umpire and, as soon as practicable, both captains of the reason for this action.
- 26.4.1.1 If the contravention is by a batsman at the wicket, the umpire shall inform the other batsman and each incoming batsman that the warning has been issued. The warning shall apply to the team of that player throughout the match.
- 26.4.2 If during the match there is any further contravention by any player of that team, the umpire shall:
- award 5 Penalty runs to the opposing side;
 - inform the other umpire, the scorers and, as soon as practicable, both captains, and, if the contravention is during play, the batsmen at the wicket.

27 THE WICKET-KEEPER

27.1 Protective equipment

The wicket-keeper is the only fielder permitted to wear gloves and external leg guards. If these are worn, they are to be regarded as part of his person for the purposes of clause 28.2 (Fielding the ball). If by the wicket-keeper's actions and positioning when the ball comes into play it is apparent to the umpires that he will not be able to carry out the normal duties of a wicket-keeper, he shall forfeit this right and also the right to be recognised as a wicket-keeper for the purposes of clauses 33.2 (A fair catch), 39 (Stumped), 28.1 (Protective equipment), 28.4 (Limitation of on-side fielders) and 28.5 (Fielders not to encroach on pitch).

27.2 Gloves

- 27.2.1 If, as permitted under clause 27.1, the wicket-keeper wears gloves, they shall have no webbing between the fingers except joining index finger and thumb, where webbing may be inserted as a means of support.
- 27.2.2 If used, the webbing shall be a single piece of non-stretch material which, although it may have facing material attached, shall have no reinforcements or tucks.

- 27.2.3 The top edge of the webbing shall not protrude beyond the straight line joining the top of the index finger to the top of the thumb and shall be taut when a hand wearing the glove has the thumb fully extended. See paragraph 3 of Appendix B.

27.3 Position of wicket-keeper

- 27.3.1 The wicket-keeper shall remain wholly behind the wicket at the striker's end from the moment the ball comes into play until a ball delivered by the bowler touches the bat or person of the striker, or passes the wicket at the striker's end, or the striker attempts a run.
- 27.3.2 In the event of the wicket-keeper contravening this clause, the striker's end umpire shall call and signal No ball as soon as applicable after the delivery of the ball.

27.4 Movement by wicket-keeper

- 27.4.1 After the ball comes into play and before it reaches the striker, it is unfair if the wicket-keeper significantly alters his position in relation to the striker's wicket, except for the following:
- 27.4.1.1 movement of a few paces forward for a slower delivery, unless in so doing it brings him within reach of the wicket.
- 27.4.1.2 lateral movement in response to the direction in which the ball has been delivered.
- 27.4.1.3 movement in response to the stroke that the striker is playing or that his actions suggest he intends to play. However the provisions of clause 27.3 shall apply.
- 27.4.2 In the event of unfair movement by the wicket-keeper, either umpire shall call and signal Dead ball.

27.5 Restriction on actions of wicket-keeper

If, in the opinion of either umpire, the wicket-keeper interferes with the striker's right to play the ball and to guard his wicket, clause 20.4.2.6 (Umpire calling and signalling Dead ball) shall apply.

If, however, either umpire considers that the interference by the wicket-keeper was wilful, then clause 41.4 (Deliberate attempt to distract striker) shall also apply.

27.6 Interference with wicket-keeper by striker

If, in playing at the ball or in the legitimate defence of his wicket, the striker interferes with the wicket-keeper, he shall not be out except as provided for in clause 37.3 (Obstructing a ball from being caught).

28 THE FIELDER

28.1 Protective equipment

No fielder other than the wicket-keeper shall be permitted to wear gloves or external leg guards. In addition, protection for the hand or fingers may be worn only with the consent of the umpires.

28.2 Fielding the ball

- 28.2.1 A fielder may field the ball with any part of his person (see paragraph 12 of Appendix A), except as in clause 28.2.1.2. However, he will be deemed to have fielded the ball illegally if, while the ball is in play he wilfully:
- 28.2.1.1 uses anything other than part of his person to field the ball.
- 28.2.1.2 extends his clothing with his hands and uses this to field the ball.
- 28.2.1.3 discards a piece of clothing, equipment or any other object which subsequently makes contact with the ball.
- 28.2.2 It is not illegal fielding if the ball in play makes contact with a piece of clothing, equipment or any other object which has accidentally fallen from the fielder's person.
- 28.2.3 If a fielder illegally fields the ball, the ball shall immediately become dead and
- the penalty for a No ball or a Wide shall stand.
 - any runs completed by the batsmen shall be credited to the batting side, together with the run in progress if the batsmen had already crossed at the instant of the offence.
 - the ball shall not count as one of the over.
- In addition the umpire shall:
- award 5 Penalty runs to the batting side.
 - inform the other umpire and the captain of the fielding side of the reason for this action.
 - inform the batsmen and, as soon as practicable, the captain of the batting side of what has occurred.

28.3 Protective helmets belonging to the fielding side

- 28.3.1 Protective helmets, when not in use by fielders, may not be placed on the ground, above the surface except behind the wicket-keeper and in line with both sets of stumps.
- 28.3.2 If the ball while in play strikes a helmet, placed as described in clause 28.3.1,
- 28.3.2.1 the ball shall become dead and, subject to clause 28.3.3,
- 28.3.2.2 an award of 5 Penalty runs shall be made to the batting side;

28.3.2.3 any runs completed by the batsmen before the ball strikes the protective helmet shall be scored, together with the run in progress if the batsmen had already crossed at the instant of the ball striking the protective helmet.

28.3.3 If the ball while in play strikes a helmet, placed as described in clause 28.3.1, unless the circumstances of clause 23.3 (Leg byes not to be awarded) or clause 34 (Hit the ball twice), apply, the umpire shall:

- permit the batsmen's runs as in clause 28.3.2.3 to be scored
- signal No ball or Wide ball to the scorers if applicable
- award 5 Penalty runs as in clause 28.3.2.2
- award any other Penalty runs due to the batting side.

28.3.4 If the ball while in play strikes a helmet, placed as described in clause 28.3.1, and the circumstances of clause 23.3 (Leg byes not to be awarded) or clause 34 (Hit the ball twice) apply, the umpire shall:

- disallow all runs to the batting side
- return any not out batsman to his original end
- signal No ball or Wide ball to the scorers if applicable
- award any 5-run Penalty that is applicable except for Penalty runs under clause 28.3.2.

28.4 Limitation of on side fielders

28.4.1 At the instant of delivery, there may not be more than 5 fielders on the leg side.

28.4.2 At the instant of the bowler's delivery there shall not be more than two fielders, other than the wicket-keeper, behind the popping crease on the on side. A fielder will be considered to be behind the popping crease unless the whole of his person whether grounded or in the air is in front of this line.

28.4.3 In the event of infringement of this clause by any fielder, the striker's end umpire shall call and signal No ball.

28.5 Fielders not to encroach on pitch

While the ball is in play and until the ball has made contact with the striker's bat or person, or has passed the striker's bat, no fielder, other than the bowler, may have any part of his person grounded on or extended over the pitch.

In the event of infringement of this clause by any fielder other than the wicket-keeper, the bowler's end umpire shall call and signal No ball as soon as possible after delivery of the ball. Note, however, clause 27.3 (Position of wicket-keeper).

28.6 Movement by any fielder other than the wicket-keeper

28.6.1 Any movement by any fielder, excluding the wicket-keeper, after the ball comes into play and before the ball reaches the striker, is unfair except for the following:

28.6.1.1 minor adjustments to stance or position in relation to the striker's wicket.

28.6.1.2 movement by any fielder, other than a close fielder, towards the striker or the striker's wicket that does not significantly alter the position of the fielder.

28.6.1.3 movement by any fielder in response to the stroke that the striker is playing or that his actions suggest he intends to play.

28.6.2 In all circumstances clause 28.4 (Limitation of on side fielders) shall apply.

28.6.3 In the event of such unfair movement, either umpire shall call and signal Dead ball.

28.6.4 Note also the provisions of clause 41.4 (Deliberate attempt to distract striker). See also clause 27.4 (Movement by wicket-keeper).

28.7 Restrictions on the placement of fielders

28.7.1 In addition to the restrictions contained in clause 28.4 above, further fielding restrictions shall apply to certain overs in each innings. The nature of such fielding restrictions and the overs during which they shall apply are set out in the following paragraphs.

28.7.2 The following fielding restrictions shall apply:

28.7.2.1 Two semi-circles shall be drawn on the field of play. The semi-circles shall have as their centre the middle stump at either end of the pitch. The radius of each of the semi-circles shall be 30 yards (27.43 metres). The semi-circles shall be linked by two parallel straight lines drawn on the field. (Refer to paragraph 2 of Appendix C). The fielding restriction areas should be marked by continuous painted white lines or 'dots' at 5 yard (4.57 metres) intervals, each 'dot' to be covered by a white plastic or rubber (but not metal) disc measuring 7 inches (18 cm) in diameter.

28.7.2.2 At the instant of delivery:

28.7.2.2.1 Powerplay 1 – no more than two (2) fielders shall be permitted outside this fielding restriction area. In an innings of 50 overs, these are overs 1 to 10 inclusive.

28.7.2.2.2 Powerplay 2 – no more than four (4) fielders shall be permitted outside this fielding restriction area. In an innings of 50 overs, these are overs 11 to 40 inclusive.

28.7.2.2.3 Powerplay 3 – no more than five (5) fielders shall be permitted outside this fielding restriction area. In an innings of 50 overs, these are overs 41 to 50 inclusive.

- 28.7.2.3 In circumstances when the number of overs of the batting team is reduced, the number of overs within each phase of the innings shall be reduced in accordance with the table below. For the sake of clarity, it should be noted that the table shall apply to both the 1st and 2nd innings of the match.

INNINGS DURATION	POWER PLAY 1	POWER PLAY 2	POWER PLAY TOTAL
20	4	12	4
21	4	13	4
22	5	13	4
23	5	14	4
24	5	14	5
25	5	15	5
26	5	16	5
27	6	16	5
28	6	17	5
29	6	17	6
30	6	18	6
31	6	19	6
32	7	19	6
33	7	20	6
34	7	20	7
35	7	21	7
36	7	22	7
37	8	22	7
38	8	23	7
39	8	23	8
40	8	24	8
41	8	25	8
42	9	25	8
43	9	26	8
44	9	26	9
45	9	27	9
46	9	28	9
47	10	28	9
48	10	29	9
49	10	29	10

- 28.7.2.4 If play is interrupted during an innings and the table above applies, the Powerplay takes immediate effect. For the avoidance of doubt this applies even if the interruption has occurred mid-over.

Illustrations:

A 50 over innings is interrupted after 8.3 overs and reduced to 32 overs. The new phases are 7+19+6. Therefore the middle phase fielding restrictions take immediate effect when play resumes and last for a further 17.3 overs. The final phase begins after 26 overs have been bowled.

A 40 over innings is interrupted after 18.5 overs and reduced to 22 overs. The new phases are 5+13+4. When play resumes, the final phase fielding restrictions apply for the remaining 3.1 overs.

- 28.7.2.5 At the commencement of the middle and final phases of an innings, the umpire shall signal such commencement to the scorers by rotating his arm in a large circle.
- 28.7.2.6 The scoreboard shall indicate the current Powerplay in progress.
- 28.7.2.7 In the event of an infringement of any of the above fielding restrictions, the square leg umpire shall call and signal No ball.

29 THE WICKET IS DOWN

29.1 Wicket put down

- 29.1.1 The wicket is put down if a bail is completely removed from the top of the stumps, or a stump is struck out of the ground,
- 29.1.1.1 by the ball,
- 29.1.1.2 by the striker's bat if held or by any part of the bat that he is holding,
- 29.1.1.3 for the purpose of this clause only, by the striker's bat not in hand, or by any part of the bat which has become detached,
- 29.1.1.4 by the striker's person or by any part of his clothing or equipment becoming detached from his person,
- 29.1.1.5 by a fielder with his hand or arm, providing that the ball is held in the hand or hands so used, or in the hand of the arm so used.
- 29.1.1.6 The wicket is also put down if a fielder strikes or pulls a stump out of the ground as in clause 29.1.1.5.
- 29.1.2 The disturbance of a bail, whether temporary or not, shall not constitute its complete removal from the top of the stumps, but if a bail in falling lodges between two of the stumps this shall be regarded as complete removal.

29.2 One bail off

If one bail is off, it shall be sufficient for the purpose of putting the wicket down to remove the remaining bail or to strike or pull any of the three stumps out of the ground, in any of the ways stated in clause 29.1.

29.3 Remaking wicket

If a wicket is broken or put down while the ball is in play, it shall not be remade by an umpire until the ball is dead. See clause 20 (Dead ball). Any fielder may, however, while the ball is in play,

- replace a bail or bails on top of the stumps.
- put back one or more stumps into the ground where the wicket originally stood.

29.4 Dispensing with bails

If the umpires have agreed to dispense with bails in accordance with clause 8.4 (Dispensing with bails), it is for the umpire concerned to decide whether or not the wicket has been put down.

- 29.4.1 After a decision to play without bails, the wicket has been put down if the umpire concerned is satisfied that the wicket has been struck by the ball, by the striker's bat, person or items of his clothing or equipment as described in clauses 29.1.1.2, 29.1.1.3 or 29.1.1.4, or by a fielder in the manner described in clause 29.1.1.5.
- 29.4.2 If the wicket has already been broken or put down, clause 29.4.1 shall apply to any stump or stumps still in the ground. Any fielder may replace a stump or stumps, in accordance with clause 29.3, in order to have an opportunity of putting the wicket down.

30 BATSMAN OUT OF HIS GROUND**30.1 When out of his ground**

- 30.1.1 A batsman shall be considered to be out of his ground unless some part of his person or bat is grounded behind the popping crease at that end.
- 30.1.2 However, a batsman shall not be considered to be out of his ground if, in running or diving towards his ground and beyond, and having grounded some part of his person or bat beyond the popping crease, there is subsequent loss of contact between the ground and any part of his person or bat, or between the bat and person.

30.2 Which is a batsman's ground

- 30.2.1 If only one batsman is within a ground, it is his ground and will remain so even if he is later joined there by the other batsman.
- 30.2.2 If both batsmen are in the same ground and one of them subsequently leaves it, the ground belongs to the batsman who remains in it.

30.2.3 If there is no batsman in either ground, then each ground belongs to whichever batsman is nearer to it, or, if the batsmen are level, to whichever batsman was nearer to it immediately prior to their drawing level.

30.2.4 If a ground belongs to one batsman then the other ground belongs to the other batsman, irrespective of his position.

30.3 Position of non-striker

The non-striker, when standing at the bowler's end, should be positioned on the opposite side of the wicket to that from which the ball is being delivered, unless a request to do otherwise is granted by the umpire.

31 APPEALS**31.1 Umpire not to give batsman out without an appeal**

Neither umpire shall give a batsman out, even though he may be out under these Playing Conditions, unless appealed to by a fielder. This shall not debar a batsman who is out under these Playing Conditions from leaving the wicket without an appeal having been made. Note, however, the provisions of clause 31.7.

31.2 Batsman dismissed

A batsman is dismissed if he is either given out by an umpire, on appeal or out under these Playing Conditions and leaves the wicket as in clause 31.1.

31.3 Timing of appeals

For an appeal to be valid, it must be made before the bowler begins his run-up or, if there is no run-up, his bowling action to deliver the next ball, and before Time has been called.

The call of Over does not invalidate an appeal made prior to the start of the following over, provided Time has not been called. See clauses 12.2 (Call of Time) and 17.2 (Start of an over).

31.4 Appeal "How's That?"

An appeal "How's That?" covers all ways of being out.

31.5 Answering appeals

The striker's end umpire shall answer all appeals arising out of any of clauses 35 (Hit wicket), 39 (Stumped) or 38 (Run out) when this occurs at the wicket-keeper's end. The bowler's end umpire shall answer all other appeals.

When an appeal is made, each umpire shall answer on any matter that falls within his jurisdiction.

When a batsman has been given Not out, either umpire may answer an appeal, made in accordance with clause 31.3, if it is on a further matter and is within his jurisdiction.

31.6 Consultation by umpires

Each umpire shall answer appeals on matters within his/her own jurisdiction. If an umpire is doubtful about any point that the other umpire may have been in a better position to see, he/she shall consult the latter on this point of fact and shall then give the decision. If, after consultation, there is still doubt remaining, the decision shall be Not out.

31.7 Batsman leaving the wicket under a misapprehension

An umpire shall intervene if satisfied that a batsman, not having been given out, has left the wicket under a misapprehension of being out. The umpire intervening shall call and signal Dead ball to prevent any further action by the fielding side and shall recall the batsman.

A batsman may be recalled at any time up to the instant when the ball comes into play for the next delivery, unless it is the final wicket of the innings, in which case it should be up to the instant when the umpires leave the field.

31.8 Withdrawal of an appeal

The captain of the fielding side may withdraw an appeal only after obtaining the consent of the umpire within whose jurisdiction the appeal falls. If such consent is given, the umpire concerned shall, if applicable, revoke the decision and recall the batsman.

The withdrawal of an appeal must be before the instant when the ball comes into play for the next delivery or, if the innings has been completed, the instant when the umpires leave the field.

32 BOWLED**32.1 Out Bowled**

32.1.1 The striker is out Bowled if his wicket is put down by a ball delivered by the bowler, not being a No ball, even if it first touches the striker's bat or person.

32.1.2 However, the striker shall not be out Bowled if before striking the wicket the ball has been in contact with any other player or an umpire. The striker will, however, be subject to clauses 37 (Obstructing the field), 38 (Run out) and 39 (Stumped).

32.2 Bowled to take precedence

The striker is out Bowled if his wicket is put down as in clause 32.1, even though a decision against him for any other method of dismissal would be justified.

33 CAUGHT**33.1 Out Caught**

The striker is out Caught if a ball delivered by the bowler, not being a No ball, touches his bat without having previously been in contact with any fielder, and is subsequently held by a fielder as a fair catch, as described in clauses 33.2 and 33.3, before it touches the ground.

33.2 A fair catch

33.2.1 A catch will be fair only if, in every case

either the ball, at any time

or any fielder in contact with the ball,

is not grounded beyond the boundary before the catch is completed. Note clauses 19.4 (Ball grounded beyond the boundary) and 19.5 (Fielder grounded beyond the boundary).

33.2.2 Furthermore, a catch will be fair if any of the following conditions applies:

33.2.2.1 the ball is held in the hand or hands of a fielder, even if the hand holding the ball is touching the ground, or is hugged to the body, or lodges in the external protective equipment worn by a fielder, or lodges accidentally in a fielder's clothing.

33.2.2.2 a fielder catches the ball after it has been lawfully struck more than once by the striker, but only if it has not been grounded since it was first struck. See clause 34 (Hit the ball twice).

33.2.2.3 a fielder catches the ball after it has touched the wicket, an umpire, another fielder or the other batsman.

33.2.2.4 a fielder catches the ball after it has crossed the boundary in the air, provided that the conditions in clause 33.2.1 are met.

33.2.2.5 the ball is caught off an obstruction within the boundary that is not designated a boundary by the umpires.

33.3 Making a catch

The act of making a catch shall start from the time when the ball first comes into contact with a fielder's person and shall end when a fielder obtains complete control over both the ball and his own movement.

33.4 No runs to be scored

If the striker is dismissed Caught, runs from that delivery completed by the batsmen before the completion of the catch shall not be scored but any runs for penalties awarded to either side shall stand. Clause 18.12 (Batsman returning to wicket he has left) shall apply from the instant of the completion of the catch.

33.5 Caught to take precedence

If the criteria of clause 33.1 are met and the striker is not out Bowled, then he is out Caught, even though a decision against either batsman for another method of dismissal would be justified.

34 HIT THE BALL TWICE**34.1 Out Hit the ball twice**

- 34.1.1 The striker is out Hit the ball twice if, while the ball is in play, it strikes any part of his person or is struck by his bat and, before the ball has been touched by a fielder, the striker wilfully strikes it again with his bat or person, other than a hand not holding the bat, except for the sole purpose of guarding his wicket. See clause 34.3 and clause 37 (Obstructing the field).
- 34.1.2 For the purpose of this clause 'struck' or 'strike' shall include contact with the person of the striker.

34.2 Not out Hit the ball twice

The striker will not be out under this clause if he

- 34.2.1 strikes the ball a second or subsequent time in order to return the ball to any fielder.
Note, however, the provisions of clause 37.4 (Returning the ball to a fielder).
- 34.2.2 wilfully strikes the ball after it has touched a fielder. Note, however the provisions of clause 37.1 (Out Obstructing the field).

34.3 Ball lawfully struck more than once

The striker may, solely in order to guard his wicket and before the ball has been touched by a fielder, lawfully strike the ball a second or subsequent time with the bat, or with any part of his person other than a hand not holding the bat. The striker may guard his wicket even if the delivery is a No ball.

However, the striker may not prevent the ball from being caught by striking the ball more than once in defence of his wicket. See clause 37.3 (Obstructing a ball from being caught).

34.4 Runs permitted from ball lawfully struck more than once

When the ball is lawfully struck more than once, as permitted in clause 34.3, if the ball does not become dead for any reason, the umpire shall call and signal Dead ball as soon as the ball reaches the boundary or at the completion of the first run. However, the umpire shall delay the call of Dead ball to allow the opportunity for a catch to be completed.

The umpire shall

- disallow all runs to the batting side
- return any not out batsman to his original end
- signal No ball to the scorers if applicable, and
- award any 5-run Penalty that is applicable except for Penalty runs under clause 28.3 (Protective helmets belonging to the fielding side).

34.5 Bowler does not get credit

The bowler does not get credit for the wicket.

35 HIT WICKET**35.1 Out Hit wicket**

- 35.1.1 The striker is out Hit wicket if, after the bowler has entered the delivery stride and while the ball is in play, his wicket is put down by either the striker's bat or person as described in clauses 29.1.1.2 to 29.1.1.4 (Wicket put down) in any of the following circumstances:
- 35.1.1.1 in the course of any action taken by him in preparing to receive or in receiving a delivery,
- 35.1.1.2 in setting off for the first run immediately after playing or playing at the ball,
- 35.1.1.3 if no attempt is made to play the ball, in setting off for the first run, providing that in the opinion of the umpire this is immediately after the striker has had the opportunity of playing the ball,
- 35.1.1.4 in lawfully making a second or further stroke for the purpose of guarding his wicket within the provisions of clause 34.3 (Ball lawfully struck more than once).
- 35.1.2 If the striker puts his wicket down in any of the ways described in clauses 29.1.1.2 to 29.1.1.4 before the bowler has entered the delivery stride, either umpire shall call and signal Dead ball.

35.2 Not out Hit wicket

The striker is not out under this clause should his wicket be put down in any of the ways referred to in clause 35.1 if any of the following applies:

- it occurs after the striker has completed any action in receiving the delivery, other than in clauses 35.1.1.2 to 35.1.1.4.
- it occurs when the striker is in the act of running, other than setting off immediately for the first run.
- it occurs when the striker is trying to avoid being run out or stumped.
- it occurs when the striker is trying to avoid a throw in at any time.
- the bowler after entering the delivery stride does not deliver the ball. In this case either umpire shall immediately call and signal Dead ball. See clause 20.4 (Umpire calling and signalling Dead ball).
- the delivery is a No ball.

36 LEG BEFORE WICKET**36.1 Out LBW**

The striker is out LBW if all the circumstances set out in clauses 36.1.1 to 36.1.5 apply.

- 36.1.1 The bowler delivers a ball, not being a No ball
- 36.1.2 the ball, if it is not intercepted full-pitch, pitches in line between wicket and wicket or on the off side of the striker's wicket
- 36.1.3 the ball not having previously touched his bat, the striker intercepts the ball, either full-pitch or after pitching, with any part of his person

- 36.14 the point of impact, even if above the level of the bails, either is between wicket and wicket or if the striker has made no genuine attempt to play the ball with the bat, is between wicket and wicket or outside the line of the off stump.
- 36.15 but for the interception, the ball would have hit the wicket.

36.2 Interception of the ball

- 36.2.1 In assessing points of impact in clauses 36.1.3, 36.1.4 and 36.1.5, only the first interception is to be considered.
- 36.2.2 In assessing clause 36.1.3, if the bowler's end umpire is not satisfied that the ball intercepted the batsman's person before it touched the bat, the batsman shall be given Not out.
- 36.2.3 In assessing clause 36.1.5, it is to be assumed that the path of the ball before interception would have continued after interception, irrespective of whether the ball might have pitched subsequently or not.

36.3 Off side of wicket

The off side of the striker's wicket shall be determined by the striker's stance at the moment the ball comes into play for that delivery. See paragraph 13 of Appendix A.

37 OBSTRUCTING THE FIELD

37.1 Out Obstructing the field

- 37.1.1 Either batsman is out Obstructing the field if, except in the circumstances of clause 37.2, and while the ball is in play, he wilfully attempts to obstruct or distract the fielding side by word or action. See also clause 34 (Hit the ball twice).
- 37.1.2 The striker is out Obstructing the field if, except in the circumstances of clause 37.2, in the act of receiving a ball delivered by the bowler, he wilfully strikes the ball with a hand not holding the bat. This will apply whether it is the first strike or a second or subsequent strike. The act of receiving the ball shall extend both to playing at the ball and to striking the ball more than once in defence of his wicket.
- 37.1.3 This clause will apply whether or not No ball is called.
- 37.1.4 For the avoidance of doubt, if an umpire feels that a batsman, in running between the wickets, has significantly changed his direction without probable cause and thereby obstructed a fielder's attempt to effect a run out, the batsman should, on appeal, be given out, obstructing the field. It shall not be relevant whether a run out would have occurred or not.
- If the change of direction involves the batsman crossing the pitch, clause 41.14 shall also apply.
- See also paragraph 2.2 of Appendix D.

37.2 Not out Obstructing the field

A batsman shall not be out Obstructing the field if obstruction or distraction is accidental, or obstruction is in order to avoid injury, or in the case of the striker, he makes a second or subsequent strike to guard his wicket lawfully as in clause 34.3 (Ball lawfully struck more than once). However, see clause 37.3.

37.3 Obstructing a ball from being caught

- 37.3.1 If the delivery is not a No ball, the striker is out Obstructing the field if wilful obstruction or distraction by either batsman prevents the striker being out caught.
- 37.3.2 Clause 37.3.1 shall apply even if an obstruction is caused by the striker in lawfully guarding his wicket under the provision of Clause 34.3 (Ball lawfully struck more than once).
- 37.3.3 If an obstruction or distraction takes place from a No ball then the batsman who caused the obstruction or distraction will be out Obstructing the field.
- 37.3.4 Clause 37.3.3 shall not apply if the striker obstructs while instinctively defending his wicket with a lawful second strike.

37.4 Returning the ball to a fielder

Either batsman is out Obstructing the field if, at any time while the ball is in play and, without the consent of a fielder, he uses the bat or any part of his person to return the ball to any fielder.

37.5 Runs scored

- When either batsman is dismissed Obstructing the field,
- 37.5.1 unless the obstruction prevents a catch from being made, any runs completed by the batsmen before the offence shall be scored, together with any runs awarded for penalties to either side. See clauses 18.6 (Runs awarded for penalties) and 18.8 (Runs scored when a batsman is dismissed).
- 37.5.2 if the obstruction prevents a catch from being made, any runs completed by the batsmen shall not be scored but any penalties awarded to either side shall stand.

37.6 Bowler does not get credit

The bowler does not get credit for the wicket.

38 RUN OUT**38.1 Out Run out**

Either batsman is out Run out, except as in clause 38.2, if, at any time while the ball is in play, he is out of his ground and his wicket is fairly put down by the action of a fielder even though No ball has been called, except in the circumstances of clause 38.2.2.2, and whether or not a run is being attempted.

38.2 Batsman not out Run out

38.2.1 A batsman is not out Run out in the circumstances of clauses 38.2.1.1 or 38.2.1.2.

38.2.1.1 He has been within his ground and has subsequently left it to avoid injury, when the wicket is put down.
Note also the provisions of clause 30.1.2 (When out of his ground).

38.2.1.2 The ball delivered by the bowler has not made contact with a fielder, before the wicket is put down.

38.2.2 The striker is not out Run out in any of the circumstances in clauses 38.2.2.1 and 38.2.2.2.

38.2.2.1 He is out Stumped. See clause 39.1.2 (Out Stumped).

38.2.2.2 No ball has been called and he is out of his ground not attempting a run and the wicket is fairly put down by the wicket-keeper without the intervention of another fielder.

38.3 Which batsman is out

The batsman out in the circumstances of clause 38.1 is the one whose ground is at the end where the wicket is put down. See clause 30.2 (Which is a batsman's ground).

38.4 Runs scored

If either batsman is dismissed Run out, the run in progress when the wicket is put down shall not be scored, but any runs completed by the batsmen shall stand, together with any runs for penalties awarded to either side. See clauses 18.6 (Runs awarded for penalties) and 18.8 (Runs scored when a batsman is dismissed).

38.5 Bowler does not get credit

The bowler does not get credit for the wicket.

39 STUMPED**39.1 Out Stumped**

- 39.1.1 The striker is out Stumped, except as in clause 39.3, if a ball which is delivered is not called No ball and he is out of his ground, other than as in clause 39.3.1 and he has not attempted a run when his wicket is fairly put down by the wicket-keeper without the intervention of another fielder. Note, however clause 27.3 (Position of wicket-keeper).
- 39.1.2 The striker is out Stumped if all the conditions of clause 39.1.1 are satisfied, even though a decision of Run out would be justified.

39.2 Ball rebounding from wicket-keeper's person

If the wicket is put down by the ball, it shall be regarded as having been put down by the wicket-keeper if the ball rebounds on to the stumps from any part of the wicket-keeper's person or equipment or has been kicked or thrown on to the stumps by the wicket-keeper.

39.3 Not out Stumped

- 39.3.1 The striker will not be out Stumped if, after having received the delivery, he has left his ground in order to avoid injury.
- 39.3.2 If the striker is not out Stumped he may, except in the circumstances of clause 38.2.2.2 (Batsman not out run out) be out Run out if the conditions of clause 38.1 (Out Run out) apply.

40 TIMED OUT**40.1 Out Timed out**

- 40.1.1 After the fall of a wicket or the retirement of a batsman, the incoming batsman must, unless Time has been called, be in position to take guard or for the other batsman to be ready to receive the next ball within 3 minutes of the dismissal or retirement. If this requirement is not met, the incoming batsman will be out, Timed out.
- 40.1.2 In the event of an extended delay in which no batsman comes to the wicket, the umpires shall adopt the procedure of clause 16.2 (ICC Match Referee awarding a match). For the purposes of that clause the start of the action shall be taken as the expiry of the 3 minutes referred to above.

40.2 Bowler does not get credit

The bowler does not get credit for the wicket.

41 UNFAIR PLAY**41.1 Fair and unfair play – responsibility of captains**

The captains are responsible for ensuring that play is conducted within the Spirit of Cricket, as well as within these Playing Conditions.

41.2 Fair and unfair play – responsibility of umpires

41.2.1 The umpires shall be the sole judges of fair and unfair play. If either umpire considers that any action by a player, not covered by these Playing Conditions, is unfair, he/she shall, call and signal Dead ball, if appropriate, as soon as it becomes clear that the call will not disadvantage the non-offending side, and report the matter to the other umpire.

- 41.2.1.1 If this is a first offence by that side, the bowler's end umpire shall then
- summon the offending player's captain and issue a first and final warning which shall apply to all members of the team for the remainder of the match.
 - warn the offending player's captain that any further such offence by any member of his team shall result in the award of 5 Penalty runs to the opposing team.
- 41.2.1.2 If this is a second or subsequent offence by that side the bowler's end umpire shall then
- summon the offending player's captain and inform him that there has been a further such offence.
 - award 5 Penalty runs to the opposing side.
- 41.2.1.3 The umpires shall may then report the matter to the ICC Match Referee who shall take such action as is considered appropriate against the player concerned.

41.3 The match ball – changing its condition

41.3.1 The umpires shall make frequent and irregular inspections of the ball. In addition, they shall immediately inspect the ball if they suspect anyone of attempting to change the condition of the ball, except as permitted in clause 41.3.2.

41.3.2 It is an offence for any player to take any action which changes the condition of the ball.

Except in carrying out his normal duties, a batsman is not allowed to wilfully damage the ball other than, when the ball is in play, in striking it with the bat. See also clause 5.5 (Damage to the ball).

A fielder may, however:

- 41.3.2.1 polish the ball on his clothing provided that no artificial substance is used and that such polishing wastes no time.
- 41.3.2.2 remove mud from the ball under the supervision of an umpire.

41.3.2.3 dry a wet ball on a piece of cloth that has been approved by the umpires.

41.3.3 The umpires shall consider the condition of the ball to have been unfairly changed if any action by any player does not comply with the conditions in clause 41.3.2.

41.3.4 If the umpires together agree that the condition of the ball has been unfairly changed by a member or members of either side, or that its condition is inconsistent with the use it has received, they shall consider that there has been a contravention of this clause and decide together whether they can identify the player(s) responsible for such conduct.

41.3.5 If it is possible to identify the player(s) responsible for changing the condition of the ball, the umpires shall;

41.3.5.1 Change the ball forthwith.

41.3.5.1.1 If the umpires together agree that the condition of the ball has been unfairly changed by a member or members of the fielding side, the batsman at the wicket shall choose the replacement ball from a selection of six other balls of various degrees of usage (including a new ball) and of the same brand as the ball in use prior to the contravention.

41.3.5.1.2 If the umpires together agree that the condition of the ball has been unfairly changed by a member or members of the batting side, the umpires shall select and bring into use immediately, a ball which shall have wear comparable to that of the previous ball immediately prior to the contravention.

41.3.5.2 Additionally, the bowler's end umpire shall

- award 5 Penalty runs to the opposing side.
- if appropriate, inform the batsmen at the wicket and the captain of the fielding side that the ball has been changed and the reason for their action.
- inform the captain of the batting side as soon as practicable of what has occurred.

The umpires shall then report the matter to the ICC Match Referee who shall take such action as is considered appropriate against the player(s) concerned.

41.3.6 If it is not possible to identify the player(s) responsible for changing the condition of the ball, the umpires shall;

41.3.6.1 Change the ball forthwith. The umpires shall choose the replacement ball for one of similar wear and of the same brand as the ball in use prior to the contravention.

41.3.6.2 The bowler's end umpire shall issue the captain with a first and final warning, and

- 41.3.6.3 Advise the captain that should there be any further instances of changing the condition of the ball by that team during the remainder of the series, clause 41.3.5.2 above will be adopted, with the captain deemed to be the player responsible for the contravention.

41.4 Deliberate attempt to distract striker

- 41.4.1 It is unfair for any fielder deliberately to attempt to distract the striker while he is preparing to receive or receiving a delivery.
- 41.4.2 If either umpire considers that any action by a fielder is such an attempt, he/she shall immediately call and signal Dead ball and inform the other umpire of the reason for the call. The bowler's end umpire shall:
- award 5 Penalty runs to the batting side.
 - inform the captain of the fielding side, the batsmen and, as soon as practicable, the captain of the batting side of the reason for the action.

Neither batsman shall be dismissed from that delivery and the ball shall not count as one of the over.

The umpires may then report the matter to the ICC Match Referee who shall take such action as is considered appropriate against the fielder concerned.

41.5 Deliberate distraction, deception or obstruction of batsman

- 41.5.1 In addition to clause 41.4, it is unfair for any fielder wilfully to attempt, by word or action, to distract, deceive or obstruct either batsman after the striker has received the ball.
- 41.5.2 It is for either one of the umpires to decide whether any distraction, deception or obstruction is wilful or not.
- 41.5.3 If either umpire considers that a fielder has caused or attempted to cause such a distraction, deception or obstruction, he/she shall immediately call and signal Dead ball and inform the other umpire of the reason for the call.
- 41.5.4 Neither batsman shall be dismissed from that delivery.
- 41.5.5 If an obstruction involves physical contact, the umpires together shall decide whether or not an offence under clause 42 (Players' conduct) has been committed.
- 41.5.5.1 If an offence under clause 42 (Players' conduct) has been committed, they shall apply the relevant procedures in clause 42 and shall also apply each of clauses 41.5.7 to 41.5.9.
- 41.5.5.2 If they consider that there has been no offence under clause 42 (Players' conduct), they shall apply each of clauses 41.5.6 to 41.5.10.
- 41.5.6 The bowler's end umpire shall:
- award 5 Penalty runs to the batting side.
 - inform the captain of the fielding side of the reason for this action and as soon as practicable inform the captain of the batting side.

- 41.5.7 The ball shall not count as one of the over.
- 41.5.8 Any runs completed by the batsmen before the offence shall be scored, together with any runs for penalties awarded to either side. Additionally, the run in progress shall be scored whether or not the batsmen had already crossed at the instant of the offence.
- 41.5.9 The batsmen at the wicket shall decide which of them is to face the next delivery.
- 41.5.10 The umpires may then report the matter to the ICC Match Referee who shall take such action as is considered appropriate against the fielder concerned.

41.6 Bowling of dangerous and unfair short pitched deliveries

- 41.6.1 Notwithstanding clause 41.6.2, the bowling of short pitched deliveries is dangerous if the bowler's end umpire considers that, taking into consideration the skill of the striker, by their speed, length, height and direction they are likely to inflict physical injury on him. The fact that the striker is wearing protective equipment shall be disregarded.

In the first instance the umpire decides that the bowling of short pitched deliveries has become dangerous under clause 41.6.1

- 41.6.1.1 The umpire shall call and signal No ball, and when the ball is dead, caution the bowler and inform the other umpire, the captain of the fielding side and the batsmen of what has occurred. This caution shall apply to that bowler throughout the innings.
- 41.6.1.2 If there is a second instance, the umpire shall repeat the above procedure and indicate to the bowler that this is a final warning, which shall apply to that bowler throughout the innings.
- 41.6.1.3 Should there be any further instance by the same bowler in that innings, the umpire shall:
- call and signal No ball
 - when the ball is dead, direct the captain of the fielding side to suspend the bowler immediately from bowling
 - inform the other umpire for the reason for this action.

The bowler thus suspended shall not be allowed to bowl again in that innings.

If applicable, the over shall be completed by another bowler, who shall neither have bowled any part of the previous over, nor be allowed to bowl any part of the next over.

- The umpire shall report the occurrence to the batsmen and, as soon as practicable, to the captain of the batting side.

The umpires may then report the matter to the ICC Match Referee who shall take such action as is considered appropriate against the bowler concerned.

- 41.6.14 A bowler shall be limited to two fast short-pitched deliveries per over.
- 41.6.15 A fast short-pitched delivery is defined as a ball, which passes or would have passed above the shoulder height of the striker standing upright at the popping crease.
- 41.6.16 The umpire at the bowler's end shall advise the bowler and the batsman on strike when each fast short pitched delivery has been bowled.
- 41.6.17 In addition, a ball that passes above head height of the batsman, standing upright at the popping crease, that prevents him from being able to hit it with his bat by means of a normal cricket stroke shall be called a Wide. See also clause 22.11.2
- 41.6.17.1 For the avoidance of doubt any fast short pitched delivery that is called a Wide under this clause shall also count as one of the allowable short pitched deliveries in that over.
- 41.6.18 In the event of a bowler bowling more than two fast short-pitched deliveries in an over as defined in clause 41.6.15 above, the umpire at the bowler's end shall call and signal No ball on each occasion. A differential signal shall be used to signify a fast short pitched delivery. The umpire shall call and signal 'No ball' and then tap the head with the other hand.
- 41.6.19 If a bowler delivers a third fast short pitched ball in an over, the umpire, after the call of No ball and when the ball is dead, shall caution the bowler, inform the other umpire, the captain of the fielding side and the batsmen at the wicket of what has occurred. This caution shall apply throughout the innings.
- 41.6.110 If there is a second instance of the bowler being No balled in the innings for bowling more than two fast short pitched deliveries in an over, the umpire shall advise the bowler that this is his final warning for the innings.
- 41.6.111 Should there be any further instance by the same bowler in that innings, the umpire shall
- call and signal No ball
 - when the ball is dead, direct the captain of the fielding side to suspend the bowler immediately from bowling
 - inform the other umpire for the reason for this action.
- The bowler thus suspended shall not be allowed to bowl again in that innings.
- If applicable, the over shall be completed by another bowler, who shall neither have bowled any part of the previous over, nor be allowed to bowl any part of the next over.

- The umpire shall report the occurrence to the batsmen and, as soon as practicable, to the captain of the batting side.

The umpires may then report the matter to the ICC Match Referee who shall take such action as is considered appropriate against the bowler concerned.

- 41.6.2 Should the umpires initiate the caution and warning procedures set out in clauses 41.6.13 and 41.7 such cautions and warnings are not to be cumulative.

41.7 Bowling of dangerous and unfair non-pitching deliveries

- 41.7.1 Any delivery, which passes or would have passed, without pitching, above waist height of the striker standing upright at the popping crease, is to be deemed to be unfair, whether or not it is likely to inflict physical injury on the striker. If the bowler bowls such a delivery the umpire shall immediately call and signal No ball.

If, in the opinion of the umpire, such a delivery is considered likely to inflict physical injury on the batsman by its speed and direction, it shall be considered dangerous. When the ball is dead the umpire shall caution the bowler, indicating that this is a first and final warning. The umpire shall also inform the other umpire, the captain of the fielding side and the batsmen of what has occurred. This caution shall apply to that bowler throughout the innings.

- 41.7.2 Should there be any further instance (where a dangerous non-pitching delivery is bowled and is considered likely to inflict physical injury on the batsman) by the same bowler in that innings, the umpire shall:

- call and signal No ball
- when the ball is dead, direct the captain of the fielding side to suspend the bowler immediately from bowling
- inform the other umpire for the reason for this action.

The bowler thus suspended shall not be allowed to bowl again in that innings.

If applicable, the over shall be completed by another bowler, who shall neither have bowled any part of the previous over, nor be allowed to bowl any part of the next over.

Additionally the umpire shall:

- report the occurrence to the batsmen and, as soon as practicable, to the captain of the batting side.

The umpires may then report the matter to the ICC Match Referee who shall take such action as is considered appropriate against the bowler concerned.

- 41.7.3 The warning sequence in clauses 41.7.1 and 41.7.2 is independent of the warning and action sequence in clause 41.6.

41.7.4 If the umpire considers that a bowler deliberately bowled a high full-pitched delivery, deemed to be dangerous and unfair as defined in clause 41.7.1, then the caution and warning in clause 41.7.1 shall be dispensed with. The umpire shall:

- immediately call and signal No ball.
- when the ball is dead, direct the captain of the fielding side to suspend the bowler immediately from bowling and inform the other umpire for the reason for this action.

The bowler thus suspended shall not be allowed to bowl again in that innings.

If applicable, the over shall be completed by another bowler, who shall neither have bowled any part of the previous over, nor be allowed to bowl any part of the next over.

- report the occurrence to the batsmen and, as soon as practicable, to the captain of the batting side.

The umpires together shall report the occurrence to the ICC Match Referee who shall take such action as is considered appropriate against the bowler concerned.

41.8 Bowling of deliberate front-foot No ball

If the umpire considers that the bowler has delivered a deliberate front-foot No ball, he/she shall:

- immediately call and signal No ball.
- when the ball is dead, direct the captain of the fielding side to suspend the bowler immediately from bowling.
- inform the other umpire for the reason for this action.

The bowler thus suspended shall not be allowed to bowl again in that innings.

If applicable, the over shall be completed by another bowler, who shall neither have bowled any part of the previous over, nor be allowed to bowl any part of the next over.

- report the occurrence to the batsmen and, as soon as practicable, to the captain of the batting side.

The umpires together shall report the occurrence to the ICC Match Referee who shall take such action as is considered appropriate against the bowler concerned.

41.9 Time wasting by the fielding side

41.9.1 It is unfair for any fielder to waste time.

41.9.2 If either umpire considers that the progress of an over is unnecessarily slow, or time is being wasted in any other way, by the captain of the fielding side or by any other fielder, at the first instance the umpire concerned shall:

- if the ball is in play, call and signal Dead ball.
- inform the other umpire of what has occurred.

The bowler's end umpire shall then:

- warn the captain of the fielding side, indicating that this is a first and final warning.
- inform the batsmen of what has occurred.

41.9.3 If either umpire considers that there is any further waste of time in that innings by any fielder, the umpire concerned shall:

- if the ball is in play, call and signal Dead ball.
- inform the other umpire of what has occurred.

The bowler's end umpire shall then award 5 Penalty runs to the batting side and inform the captain of the fielding side of the reason for this action.

Additionally the umpire shall inform the batsmen and, as soon as is practicable, the captain of the batting side of what has occurred.

If the umpires believe that the act of time wasting was deliberate or repetitive, they may lodge a report under the ICC Code of Conduct. In such circumstances the Captain and/or any individual members of the fielding team responsible for the time wasting will be charged.

41.10 Batsman wasting time

41.10.1 It is unfair for a batsman to waste time. In normal circumstances, the striker should always be ready to take strike when the bowler is ready to start his run-up.

In addition, an incoming batsman should be in position to take guard or his partner ready to receive the next ball within 2 minutes of the fall of the previous wicket.

41.10.2 Should either batsman waste time by failing to meet this requirement, or in any other way, the following procedure shall be adopted. At the first instance, either before the bowler starts his run-up or when the ball becomes dead, as appropriate, the umpire shall:

- warn both batsmen and indicate that this is a first and final warning. This warning shall apply throughout the innings. The umpire shall so inform each incoming batsman.
- inform the other umpire of what has occurred.
- inform the captain of the fielding side and, as soon as practicable, the captain of the batting side of what has occurred.

41.10.3 If there is any further time wasting by any batsman in that innings, the umpire shall, at the appropriate time while the ball is dead:

- award 5 Penalty runs to the fielding side.
- inform the other umpire of the reason for this action.
- inform the other batsman, the captain of the fielding side and, as soon as practicable, the captain of the batting side of what has occurred.

If the umpires believe that the act of time wasting was deemed to be deliberate or repetitive, they may lodge a report under the ICC Code of Conduct. In such circumstances the batsman concerned will be charged.

41.11 The protected area

The protected area is defined as that area of the pitch contained within a rectangle bounded at each end by imaginary lines parallel to the popping creases and 5 ft/1.52 m in front of each, and on the sides by imaginary lines, one each side of the imaginary line joining the centres of the two middle stumps, each parallel to it and 1 ft/30.48 cm from it.

41.12 Fielder damaging the pitch

41.12.1 It is unfair to cause deliberate or avoidable damage to the pitch. A fielder will be deemed to be causing avoidable damage if either umpire considers that his presence on the pitch is without reasonable cause.

41.12.2 If a fielder causes avoidable damage to the pitch, other than as in clause 41.13.1, at the first instance the umpire seeing the contravention shall, when the ball is dead, inform the other umpire. The bowler's end umpire shall then:

- caution the captain of the fielding side and indicate that this is a first and final warning. This warning shall apply throughout the innings.
- inform the batsmen of what has occurred.

41.12.3 If, in that innings, there is any further instance of avoidable damage to the pitch, by any fielder, the umpire seeing the contravention shall, when the ball is dead, inform the other umpire. The bowler's end umpire shall then:

- award 5 Penalty runs to the batting side.
- Additionally the umpire shall
- inform the fielding captain of the reason for this action.
 - inform the batsmen and, as soon as practicable, the captain of the batting side of what has occurred.

The umpires together shall report the occurrence to the ICC Match Referee who shall take such action as is considered appropriate against the fielder concerned.

41.13 Bowler running on protected area

41.13.1 It is unfair for a bowler to enter the protected area in his follow-through without reasonable cause, whether or not the ball is delivered.

41.13.2 If a bowler contravenes this clause, at the first instance and when the ball is dead, the umpire shall:

- caution the bowler and inform the other umpire of what has occurred. This caution shall apply to that bowler throughout the innings.
- inform the captain of the fielding side and the batsmen of what has occurred.

41.13.3 If, in that innings, the same bowler again contravenes this clause, the umpire shall repeat the above procedure indicating that this is a final warning. This warning shall also apply throughout the innings.

41.13.4 If, in that innings, the same bowler contravenes this clause a third time, when the ball is dead, the umpire shall,

- direct the captain of the fielding side to suspend the bowler immediately from bowling. If applicable, the over shall be completed by another bowler, who shall neither have bowled any part of the previous over, nor be allowed to bowl any part of the next over. The bowler taken off shall not be allowed to bowl again in that innings.
- inform the other umpire of the reason for this action.
- inform the batsmen and, as soon as practicable, the captain of the batting side of what has occurred.

The umpires may then report the matter to the ICC Match Referee who shall take such action as is considered appropriate against the bowler concerned.

41.14 Batsman damaging the pitch

41.14.1 It is unfair to cause deliberate or avoidable damage to the pitch. If the striker enters the protected area in playing or playing at the ball, he must move from it immediately thereafter. A batsman will be deemed to be causing avoidable damage if either umpire considers that his presence on the pitch is without reasonable cause.

41.14.2 If either batsman causes deliberate or avoidable damage to the pitch, other than as in clause 41.15, at the first instance the umpire seeing the contravention shall, when the ball is dead, inform the other umpire of the occurrence. The bowler's end umpire shall then:

- warn both batsmen that the practice is unfair and indicate that this is a first and final warning. This warning shall apply throughout the innings. The umpire shall so inform each incoming batsman.
- inform the captain of the fielding side and, as soon as practicable, the captain of the batting side of what has occurred.

41.14.3 If there is any further instance of avoidable damage to the pitch by any batsman in that innings, the umpire seeing the contravention shall, when the ball is dead, inform the other umpire of the occurrence.

The bowler's end umpire shall:

- disallow all runs to the batting side.
- return any not out batsman to his original end.
- signal No ball or Wide to the scorers if applicable.
- award 5 Penalty runs to the fielding side.

- award any other 5-run Penalty that is applicable except for Penalty runs under clause 28.3 (Protective helmets belonging to the fielding side).
- Inform the captain of the fielding side and, as soon as practicable, the captain of the batting side of the reason for this action.

The umpires together shall report the occurrence to the ICC Match Referee who shall take such action as is considered appropriate against the batsman concerned.

41.15 Striker in protected area

- 41.15.1 The striker shall not adopt a stance in the protected area or so close to it that frequent encroachment is inevitable.

The striker may mark a guard on the pitch provided that no mark is unreasonably close to the protected area.

- 41.15.2 If either umpire considers that the striker is in breach of any of the conditions in clause 41.15.1, if the bowler has not entered the delivery stride, he/she shall immediately call Dead ball, otherwise, wait until the ball is dead; he/she shall then inform the other umpire of the occurrence.

The bowler's end umpire shall then:

- warn the striker that the practice is unfair and indicate that this is a first and final warning. This warning shall apply throughout the innings. The umpire shall so inform the non-striker and each incoming batsman.
- inform the captain of the fielding side and, as soon as practicable, the captain of the batting side of what has occurred.

- 41.15.3 If there is any further breach of any of the conditions in clause 41.15.1 by any batsman in that innings, the umpire seeing the contravention shall, if the bowler has not entered his delivery stride, immediately call and signal Dead ball, otherwise, he/she shall wait until the ball is dead and then inform the other umpire of the occurrence.

The bowler's end umpire shall:

- disallow all runs to the batting side.
- return any not out batsman to his original end.
- signal No ball or Wide to the scorers if applicable.
- award 5 Penalty runs to the fielding side.
- award any other 5-run Penalty that is applicable except for Penalty runs under clause 28.3 (Protective helmets belonging to the fielding side).
- inform the captain of the fielding side and, as soon as practicable, the captain of the batting side of the reason for this action.

The umpires together shall report the occurrence to the ICC Match Referee who shall take such action as is considered appropriate against the batsman concerned.

41.16 Non-striker leaving his ground early

If the non-striker is out of his ground from the moment the ball comes into play to the instant when the bowler would normally have been expected to release the ball, the bowler is permitted to attempt to run him out. Whether the attempt is successful or not, the ball shall not count as one in the over.

If the bowler fails in an attempt to run out the non-striker, the umpire shall call and signal Dead ball as soon as possible.

41.17 Batsmen stealing a run

- 41.17.1 It is unfair for the batsmen to attempt to steal a run during the bowler's run-up.

Unless the bowler attempts to run out either batsman – see clauses 41.16 and 21.4 (Bowler throwing towards striker's end before delivery) – the umpire shall:

- call and signal Dead ball as soon as the batsmen cross in such an attempt.
- inform the other umpire of the reason for this action.

The bowler's end umpire shall then:

- return the batsmen to their original ends.
- award 5 Penalty runs to the fielding side.
- inform the batsmen, the captain of the fielding side and, as soon as practicable, the captain of the batting side, of the reason for this action.

The umpires may then report the matter to the ICC Match Referee who shall take such action as is considered appropriate against the batsman concerned.

41.18 Penalty runs

- 41.18.1 When Penalty runs are awarded to either side, when the ball is dead the umpire shall signal the Penalty runs to the scorers. See clause 2.13 (Signals).
- 41.18.2 Penalty runs shall be awarded in each case where these Playing Conditions require the award, even if a result has already been achieved. See clause 16.6 (Winning hit or extras).
- Note, however, that the restrictions on awarding Penalty runs, in clauses 23.3 (Leg byes not to be awarded), 34.4 (Runs scored from ball lawfully struck more than once) and 28.3 (Protective helmets belonging to the fielding side), will apply.
- 41.18.3 When 5 Penalty runs are awarded to the batting side under any of clauses 24.4 (Player returning without permission), 28.2 (Fielding the ball), 28.3 (Protective helmets belonging to the fielding side) or under 41.3, 41.4, 41.5, 41.9 or 41.12, then:
- they shall be scored as Penalty extras and shall be in addition to any other penalties.

- they are awarded when the ball is dead and shall not be regarded as runs scored from either the immediately preceding delivery or the immediately following delivery, and shall be in addition to any runs from those deliveries.
- the batsmen shall not change ends solely by reason of the 5 run penalty.

41.18.4 When 5 Penalty runs are awarded to the fielding side, under clause 18.5.2 (Deliberate short runs), or under 41.10, 41.14, 41.15 or 41.17, they shall be added as Penalty extras to that side's total of runs in its most recently completed innings. If the fielding side has not completed an innings, the 5 Penalty runs shall be added to the score in its next innings.

42 PLAYERS' CONDUCT

42.1 Serious misconduct

- 42.1.1 The umpires shall act upon any serious misconduct. The relevant offences and the corresponding actions by the umpires are identified in clause 42.2.1. These offences correspond with Level 4 offences in the ICC Code of Conduct. Level 1 to Level 3 offences continue to be dealt with separately under the ICC Code of Conduct.
- 42.1.2 If either umpire considers that a player has committed one of these offences at any time during the match, the umpire concerned shall call and signal Dead ball. This call may be delayed until the umpire is satisfied that it will not disadvantage the non-offending side.
- 42.1.3 The umpire concerned shall report the matter to the other umpire and together they shall decide whether an offence has been committed. The umpires may also consult with the third umpire and the match referee, who may review any audio or video replays to confirm whether an offence has been committed. If so, the umpires shall then apply the related sanctions.
- 42.1.4 If the offence is committed by a batsman, the umpires shall summon the offending player's captain to the field. Solely for the purpose of this clause, the batsmen at the wicket may not deputise for their captain.

42.2 Level 4 offences and action by umpires

- 42.2.1 Any of the following actions by a player shall constitute a Level 4 offence:
- threatening to assault an umpire
 - making inappropriate and deliberate physical contact with an umpire
 - physically assaulting a player or any other person
 - committing any other act of violence.

42.2.2 If such an offence is committed, 42.2.2.1 to 42.2.2.5 shall be implemented.

42.2.2.1 The umpire shall call Time.

42.2.2.2 Together the umpires shall summon and inform the offending player's captain that an offence at this Level has occurred.

42.2.2.3 The umpires shall instruct the captain to remove the offending player immediately from the field of play for the remainder of the match and shall apply the following:

42.2.2.3.1 If the offending player is a fielder, no substitute shall be allowed for him. He is to be recorded as Retired – out at the commencement of any subsequent innings in which his team is the batting side.

42.2.2.3.2 If a bowler is suspended mid-over, then that over must be completed by a different bowler, who shall not have bowled the previous over nor shall be permitted to bowl the next over.

42.2.2.3.3 If the offending player is a batsman he is to be recorded as Retired – out in the current innings, unless he has been dismissed under any of clauses 32 to 39, and at the commencement of any subsequent innings in which his team is the batting side. If no further batsman is available to bat, the innings is completed.

42.2.2.4 As soon as practicable, the umpire shall:

- award 5 Penalty runs to the opposing team
- signal the Level 4 penalty to the scorers
- call Play.

42.2.2.5 The umpires shall then report the matter to the ICC Match Referee under the ICC Code of Conduct.

42.3 Captain refusing to remove a player from the field

42.3.1 If a captain refuses to carry out an instruction under 42.2.2.3, the umpires shall invoke clause 16.2 (ICC Match Referee awarding a match).

42.3.2 If both captains refuse to carry out instructions under 42.2.2.3 in respect of the same incident, the umpires shall instruct the players to leave the field. The match is not concluded as in clause 12.6 and there shall be no result under clause 16.

42.4 Additional points relating to Level 4 offences

- 42.4.1 If a player, while acting as wicket-keeper, commits a Level 4 offence, clause 24.1.2 shall not apply, meaning that only a nominated player may keep wicket, even if another fielder becomes injured or ill and is replaced by a substitute.
- 42.4.2 A nominated player who has a substitute will also suffer the penalty for any Level 4 offence committed by the substitute. However, only the substitute will be reported under clause 42.2.2.5.

APPENDICES TO ICC ONE DAY INTERNATIONAL MATCH PLAYING CONDITIONS

(INCORPORATING THE 2017 CODE OF THE MCC LAWS OF CRICKET)

A. Definitions

B. Equipment

1. The bat
2. The wickets
3. Wicket-keeping gloves

C. The venue

1. The pitch and the creases
2. Advertising on grounds, perimeter boards and sight-screens
3. Markings on outfield

D. Decision Review System (DRS) and Third Umpire Protocol

E. Calculations

APPENDIX A

DEFINITIONS

1 THE MATCH

- 1.1 **The game** is used in these Playing Conditions as a general term meaning the Game of Cricket.
- 1.2 **A match** is a single One Day International between two teams, played under these Playing Conditions.
- 1.3 **ODI** is an abbreviation for One Day International.
- 1.4 **The toss** is the toss for choice of innings.
- 1.5 **Before the toss** is at any time before the toss on the day the match is expected to start.
- 1.6 **Before the match** is at any time before the toss, not restricted to the day of the match.
- 1.7 **During the match** is at any time after the toss until the conclusion of the match, whether play is in progress or not.
- 1.8 **Playing time** is any time between the call of Play and the call of Time. See clauses 12.1 (Call of Play) and 12.2 (Call of Time).
- 1.9 **Conduct of the match** includes any action relevant to the match at any time.
- 1.10 **Ground Authority** is the entity responsible for the selection and preparation of the pitch and other functions relating to the hosting and management of the match, including any agents acting on their behalf (including but not limited to the curator or other ground staff).
- 1.11 **Home Board** is the ICC member responsible for the home team and the hosting of the match.
- 1.12 **Visiting Board** is the ICC member responsible for the visiting team.
- 1.13 A **Reserve Day** is, where scheduled, an additional day for the completion of the match.
- 1.14 **The Spirit of Cricket** refers to the values of respect and fair play that underpin the game of cricket, as set out in the Preamble to these Playing Conditions.
- 1.15 **The ICC Code of Conduct** is the ICC Code of Conduct for Players and Player Support Personnel, as amended from time to time.

2 IMPLEMENTS AND EQUIPMENT

- 2.1 **Implements used in the match** are the bat, the ball, the stumps and balls.
- 2.2 **External protective equipment** is any visible item of apparel worn for protection against external blows.

For a batsman, items permitted are a protective helmet, external leg guards (batting pads), batting gloves and, if visible, forearm guards.

For a fielder, only a protective helmet is permitted, except in the case of a wicket-keeper, for whom wicket-keeping pads and gloves are also permitted.

- 2.3 **A protective helmet** is headwear made of hard material and designed to protect the head or the face or both, which shall (in line with the Clothing and Equipment Regulations) be certified to BS7928:2013. For the purposes of interpreting these Playing Conditions, such a description will include faceguards.
- 2.4 **Equipment** – a batsman's equipment is his bat as defined above, together with any external protective equipment he is wearing.

A fielder's equipment is any external protective equipment that he is wearing.
- 2.5 **The bat** – the following are to be considered as part of the bat:
 - the whole of the bat itself.
 - the whole of a glove (or gloves) worn on the hand (or hands) holding the bat.
 - the hand (or hands) holding the bat, if the batsman is not wearing a glove on that hand or on those hands.
- 2.6 **Held in batsman's hand.** Contact between a batsman's hand, or glove worn on his hand, and any part of the bat shall constitute the bat being held in that hand.

3 THE PLAYING AREA

- 3.1 **The field of play** is the area contained within the boundary.
- 3.2 **The square** is a specially prepared area of the field of play within which the match pitch is situated.
- 3.3 **The outfield** is that part of the field of play between the square and the boundary.

4 POSITIONING

- 4.1 **Behind the popping crease** at one end of the pitch is that area of the field of play, including any other marking, objects and persons therein, that is on that side of the popping crease that does not include the creases at the opposite end of the pitch. **Behind**, in relation to any other marking, object or person, follows the same principle. See the diagram in paragraph 13.
- 4.2 **In front of the popping crease** at one end of the pitch is that area of the field of play, including any other marking, objects and persons therein, that is on that side of the popping crease that includes the creases at the opposite end of the pitch. In front of, in relation to any other marking, object or person, follows the same principle. See the diagram in paragraph 13.
- 4.3 **The striker's end** is the place where the striker stands to receive a delivery from the bowler only insofar as it identifies, independently of where the striker may subsequently move, one end of the pitch.
- 4.4 **The bowler's end** is the end from which the bowler delivers the ball. It is the other end of the pitch from the striker's end and identifies that end of the pitch that is not the striker's end as described in paragraph 4.3.
- 4.5 **The wicket-keeper's end** is the same as the striker's end as described in paragraph 4.3.

- 4.6 In front of the line of the striker's wicket** is in the area of the field of play in front of the imaginary line joining the fronts of the stumps at the striker's end; this line to be considered extended in both directions to the boundary. See paragraph 4.2.
- 4.7 Behind the wicket** is in the area of the field of play behind the imaginary line joining the backs of the stumps at the appropriate end; this line to be considered extended in both directions to the boundary. See paragraph 4.1.
- 4.8 Behind the wicket-keeper** is behind the wicket at the striker's end, as defined above, but in line with both sets of stumps and further from the stumps than the wicket-keeper.
- 4.9 Off side/on (leg) side** – see diagram in paragraph 13.
- 4.10 Inside edge** is the edge on the same side as the nearer wicket.

5 UMPIRES AND DECISION-MAKING

- 5.1 Umpire** – where the description **the umpire** is used on its own, it always means 'the bowler's end umpire' though this full description is sometimes used for emphasis or clarity. Similarly **the umpires** always means both umpires and the third umpire. **An umpire** and **umpires** are generalised terms. Otherwise, a fuller description indicates which one of the umpires is specifically intended. Each umpire will be bowler's end umpire and striker's end umpire in alternate overs.
- 5.2 Bowler's end umpire** is the umpire who is standing at the bowler's end (see paragraph 4.4) for the current delivery.
- 5.3 Striker's end umpire** is the umpire who is standing at the striker's end (see paragraph 4.3), to one side of the pitch or the other, depending on his/her choice, for the current delivery.
- 5.4 On-field umpires** shall mean, collectively, the bowler's end umpire and the striker's end umpire.
- 5.5 Third umpire** is the umpire who may use television evidence and other available technology in order review a decision of the on-field umpires, either by way of an Umpire Review or a Player Review under the protocol set out in Appendix D.
- 5.6 Umpires together agree** applies to decisions which the umpires are to make jointly, independently of the players.
- 5.7 Decision Review System** or **DRS** is the process covered by the Decision Review System and Third Umpire Protocol set out in Appendix D, under which the third umpire may be consulted in relation to a decision of the on-field umpires, either by way of an Umpire Review or a Player Review.
- 5.8 Player Review** is the process set out in Appendix D by which a player may request a review of any decision taken by the on-field umpires concerning whether or not a batsman is dismissed (with the exception of Timed out).
- 5.9 Umpire Review** is the process set out in Appendix D by which an on-field umpire has the discretion to refer a decision to the third umpire or, under certain circumstances, to consult with the third umpire before making a decision.

- 5.10 Soft Signal** is the visual communication by the bowler's end umpire to the third umpire (accompanied by additional information via two-way radio where necessary) of his/her initial on-field decision prior to initiating an Umpire Review.
- 5.11 Umpire's Call** is the concept within the DRS under which the on-field decision of the bowler's end umpire shall stand, which shall apply under the specific circumstances set out in paragraphs 3.4.5 and 3.4.6 of Appendix D, where the ball-tracking technology indicates a marginal decision in respect of either the Impact Zone or the Wicket Zone.
- 5.12 The Pitching Zone** as used in the DRS is a two dimensional area on the pitch between both sets of stumps with its boundaries consisting of the base of both sets of stumps and a line between the outside of the outer stumps at each end.
- 5.13 The Impact Zone** as used in the DRS is a three dimensional space extending between both sets of stumps to an indefinite height vertically and with its boundaries consisting of the base of the stumps and the outside of the outer stumps at each end.
- 5.14 The Wicket Zone** as used in the DRS is a two dimensional area with its boundaries consisting of the outside of the outer stumps, the base of the stumps, and the lower edge of the bails.
- 5.15 A Fair Catch** is a catch that has been taken cleanly by the fielder in accordance with clause 33.
- 5.16 A Bump Ball** is where the ball has made contact with the ground shortly after making contact with the striker's bat.
- 5.17 The Elite Panel** is the group of umpires contracted to the ICC to officiate in international cricket.
- 5.18 The International Panel** is the group of umpires nominated by the ICC's full members in accordance with clause 2.1.3 of the Playing Conditions.

6 BATSMEN

- 6.1 Batting side** is the side currently batting, whether or not play is in progress.
- 6.2 Member of the batting side** is one of the players nominated by the captain of the batting side, or any authorised replacement for such nominated player.
- 6.3 A batsman's ground** – at each end of the pitch, the whole area of the field of play behind the popping crease is the ground at that end for a batsman.
- 6.4 Original end** is the end where a batsman was when the ball came into play for that delivery.
- 6.5 Wicket he has left** is the wicket at the end where a batsman was at the start of the run in progress.
- 6.6 Guard position** is the position and posture adopted by the striker to receive a ball delivered by the bowler
- 6.7** For the purposes of these Playing Conditions, waist height is defined as the point at which the top of the batsman's trousers would conventionally be when he is standing upright at the popping crease.

7 FIELDERS

- 7.1 Fielding side** is the side currently fielding, whether or not play is in progress.
- 7.2 Member of the fielding side** is one of the players nominated by the captain of the fielding side, or any authorised replacement or substitute for such nominated player.
- 7.3 Fielder** is one of the 11 or fewer players who together represent the fielding side on the field of play. This definition includes not only both the bowler and the wicket-keeper but also nominated players who are legitimately on the field of play, together with players legitimately acting as substitutes for absent nominated players. It excludes any nominated player who is absent from the field of play, or who has been absent from the field of play and who has not yet obtained the umpire's permission to return.

A player going briefly outside the boundary in the course of discharging his duties as a fielder is not absent from the field of play nor, for the purposes of clause 24.2 (Fielder absent or leaving the field of play), is he to be regarded as having left the field of play.

8 SUBSTITUTES AND CONCUSSION REPLACEMENTS

- 8.1 A Substitute** is a player who takes the place of a fielder on the field of play, but does not replace the player for whom he substitutes on that side's list of nominated players. A substitute's activities are limited to fielding.
- 8.2 A Concussion Replacement** is a player who takes the place of a player who has been replaced in accordance with the process set out in clause 12.7, and who for the remainder of the match replaces that player on that side's list of nominated players, being able to take a full part in the match (subject to such restrictions as may be imposed by the ICC Match Referee in accordance with clause 12.7.4).
- 8.3 A Concussion Replacement Request** is the notification made to the ICC Match Referee in accordance with the process set out in clause 12.7.3.
- 8.4 The Team Medical Representative** is the individual designated as having responsibility for the assessment of any head or neck injury sustained by a player as set out in clause 12.7.2.

9 BOWLERS

- 9.1 Over the wicket/round the wicket** – If, as the bowler runs up between the wicket and the return crease, the wicket is on the same side as his bowling arm, he is bowling over the wicket. If the return crease is on the same side as his bowling arm, he is bowling round the wicket.
- 9.2 Delivery swing** is the motion of the bowler's arm during which he normally releases the ball for a delivery.
- 9.3 Delivery stride** is the stride during which the delivery swing is made, whether the ball is released or not. It starts when the bowler's back foot lands for that stride and ends when the front foot lands in the same stride. The stride after the delivery stride is completed when the next foot lands, i.e. when the back foot of the delivery stride lands again.

- 9.4 The Illegal Bowling Regulations** are the ICC's regulations governing Illegal Bowling Actions.
- 9.5 An Illegal Bowling Action** is a bowling action where a bowler's Elbow Extension exceeds 15 degrees, measured from the point at which the bowling arm reaches the horizontal until the point at which the ball is released (any Elbow Hyperextension shall be discounted for the purposes of determining an Illegal Bowling Action).
- 9.6 Elbow Extension** means the motion that occurs when a bowler's arm moves from a flexed (bent) position at the elbow, to a more extended (straight) position (full Elbow Extension occurs when the arm is straight).
- 9.7 Elbow Hyperextension** is the motion that occurs when a bowler's elbow extends beyond the straight position.
- 9.8 The ICC Bowling Action Report Form** is the form provided for by Article 3 of the Illegal Bowling Regulations, by which an umpire and/or the ICC Match Referee may submit a report relating to a suspected Illegal Bowling Action.

10 THE BALL

- 10.1 The ball is struck/strikes the ball** unless specifically defined otherwise, mean 'the ball is struck by the bat'/'strikes the ball with the bat'.
- 10.2 Rebounds directly/strikes directly** and similar phrases mean 'without contact with any fielder' but do not exclude contact with the ground.
- 10.3 Full-pitch** describes a ball delivered by the bowler that reaches or passes the striker without having touched the ground. Sometimes described as non-pitching.

11 RUNS

- 11.1 A run to be disallowed** is one that in these Playing Conditions should not have been taken. It is not only to be cancelled but the batsmen are to be returned to their original ends.
- 11.2 A run not to be scored** is one that is not illegal, but is not recognised as a properly executed run. It is not a run that has been made, so the question of cancellation does not arise. The loss of the run so attempted is not a disallowance and the batsmen will not be returned to their original ends on that account.

12 THE PERSON

- 12.1 Person:** A player's person is his physical person (flesh and blood) together with any clothing or legitimate external protective equipment that he is wearing except, in the case of a batsman, his bat.

A hand, whether gloved or not, that is not holding the bat is part of the batsman's person.

No item of clothing or equipment is part of the player's person unless it is attached to him.

For a batsman, a glove being held but not worn is part of his person.

For a fielder, an item of clothing or equipment he is holding in his hand or hands is not part of his person.

- 12.2 **Clothing** – anything that a player is wearing, including such items as spectacles or jewellery, that is not classed as external protective equipment is classed as clothing, even though he may be wearing some items of apparel, which are not visible, for protection. A bat being carried by a batsman does not come within this definition of clothing.
- 12.3 **Hand** for batsman or wicket-keeper shall include both the hand itself and the whole of a glove worn on the hand.

13 OFF SIDE/ON SIDE; IN FRONT OF/
BEHIND THE POPPING CREASE

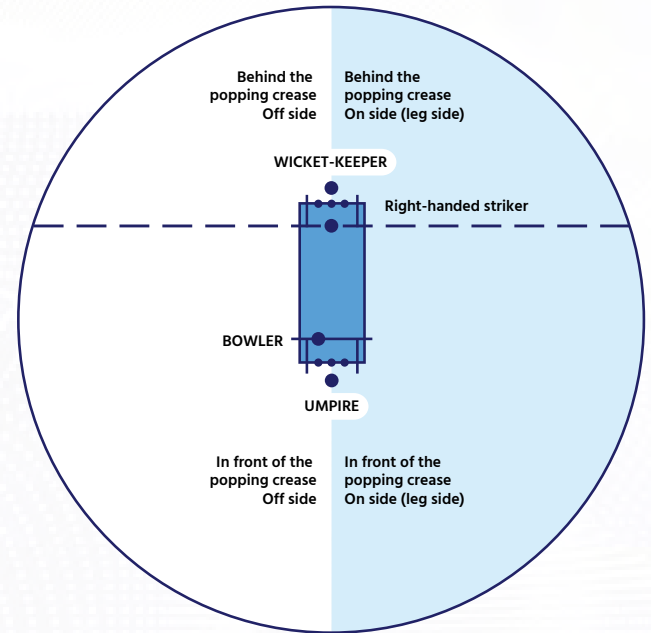

APPENDIX B

EQUIPMENT

1 THE BAT

1.1 General guidance

- 1.1.1 **Measurements** – All provisions in paragraphs 1.2 to 1.6 below are subject to the measurements and restrictions stated in the Playing Conditions and this Appendix.
- 1.1.2 **Adhesives** – Throughout, adhesives are permitted only where essential and only in minimal quantity.

1.2 Specifications for the Handle

- 1.2.1 One end of the handle is inserted into a recess in the blade as a means of joining the handle and the blade.
- This lower portion is used purely for joining the blade and the handle together. It is not part of the blade but, solely in interpreting paragraphs 1.3 and 1.4 below, references to the blade shall be considered to extend also to this lower portion of the handle where relevant.
- 1.2.2 The handle may be glued where necessary and bound with twine along the upper portion.
- Providing clause 5.5 is not contravened, the upper portion may be covered with materials solely to provide a surface suitable for gripping. Such covering is an addition and is not part of the bat, except in relation to clause 5.6. The bottom of this grip should not extend below the point defined in paragraph 1.2.4 below.
- Twine binding and the covering grip may extend beyond the junction of the upper and lower portions of the handle, to cover part of the shoulders of the bat as defined in paragraph 1.3.1.
- No material may be placed on or inserted into the lower portion of the handle other than as permitted above together with the minimal adhesives or adhesive tape used solely for fixing these items, or for fixing the handle to the blade.
- 1.2.3 **Materials in handle** – As a proportion of the total volume of the handle, materials other than cane, wood or twine are restricted to one-tenth. Such materials must not project more than 3.25 in/8.26 cm into the lower portion of the handle
- 1.2.4 **Binding and covering of handle** – The permitted continuation beyond the junction of the upper and lower portions of the handle is restricted to a maximum, measured along the length of the handle, of:
- 2.5 in/6.35 cm in for the twine binding
 - 2.75 in/6.99 cm for the covering grip.

1.3 Specifications for the Blade

- 1.3.1 The blade has a face, a back, a toe, sides and shoulders:
- 1.3.1.1 The face of the blade is its main striking surface and shall be flat or have a slight convex curve resulting from traditional pressing techniques. The back is the opposite surface.
- 1.3.1.2 The shoulders, sides and toe are the remaining surfaces, separating the face and the back.
- 1.3.1.3 The shoulders, one on each side of the handle, are along that portion of the blade between the first entry point of the handle and the point at which the blade first reaches its full width.
- 1.3.1.4 The toe is the surface opposite to the shoulders taken as a pair.
- 1.3.1.5 The sides, one each side of the blade, are along the rest of the blade, between the toe and the shoulders.
- 1.3.2 No material may be placed on or inserted into the blade other than as permitted in paragraph 1.2.4, paragraph 1.3.3, and clause 5.4 together with the minimal adhesives or adhesive tape used solely for fixing these items, or for fixing the handle to the blade.
- 1.3.3 Covering the blade. Bats shall have no covering on the blade except as permitted in clause 5.4.
- Any materials referred to above, in clause 5.4 and paragraph 1.4 below, are to be considered as part of the bat, which must still pass through the gauge as defined in paragraph 1.6.

1.4 Protection and repair

- 1.4.1 The surface of the blade may be treated with non-solid materials to improve resistance to moisture penetration and/or mask natural blemishes in the appearance of the wood. Save for the purpose of giving a homogeneous appearance by masking natural blemishes, such treatment shall not materially alter the colour of the blade.
- 1.4.2 Materials can be used for protection and repair as stated in clause 5.4 and are additional to the blade. Note however clause 5.6.
- Any such material shall not extend over any part of the back of the blade except in the case of clause 5.4.1 and then only when it is applied as a continuous wrapping covering the damaged area.
- The repair material shall not extend along the length of the blade more than 0.79 in/2.0 cm in each direction beyond the limits of the damaged area. Where used as a continuous binding, any overlapping shall not breach the maximum of 0.04 in/0.1 cm in total thickness.
- The use of non-solid material which when dry forms a hard layer more than 0.004 in/0.01 cm in thickness is not permitted.

- 1.4.3 Permitted coverings, repair material and toe guards, not exceeding their specified thicknesses, may be additional to the dimensions above, but the bat must still pass through the gauge as described in paragraph 1.6.

1.5 Commercial identifications

Such identifications shall comply with the restrictions set out in the Clothing and Equipment Regulations in relation to the size and position of marks and logos.

1.6 Bat Gauge

All bats must meet the specifications defined in clause 5.7. They must also, with or without protective coverings permitted in clause 5.4, be able to pass through a bat gauge, the dimensions and shape of which are shown in the following diagram:

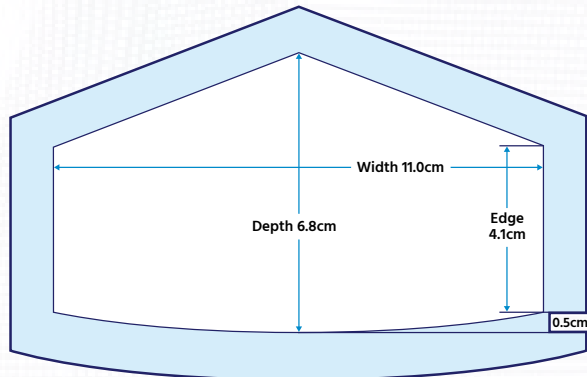

DIMENSIONS OF APERTURE

Total Depth: 2.68 in/6.8 cm

Width: 4.33 in/11.0 cm

Edge: 1.61 in/4.1 cm

Curve: 0.20 in/0.5 cm

Note: The curve of the lower edge of the aperture is an arc of a circle of radius 12.0 in/30.5 cm, whose centre is on the vertical centre line of the aperture.

2 THE WICKETS

2.1 Bails

Overall 4.31 in/10.95 cm

a = 1.38 in/3.50 cm

b = 2.13 in/5.40 cm

c = 0.81 in/2.06 cm

2.2 Stumps

Height (d) = 28 in/71.1 cm

Diameter (e) – maximum = 1.5 in/3.81 cm; minimum = 1.38 in/3.50 cm

2.3 Overall

Width (f) of wicket 9 in/22.86 cm

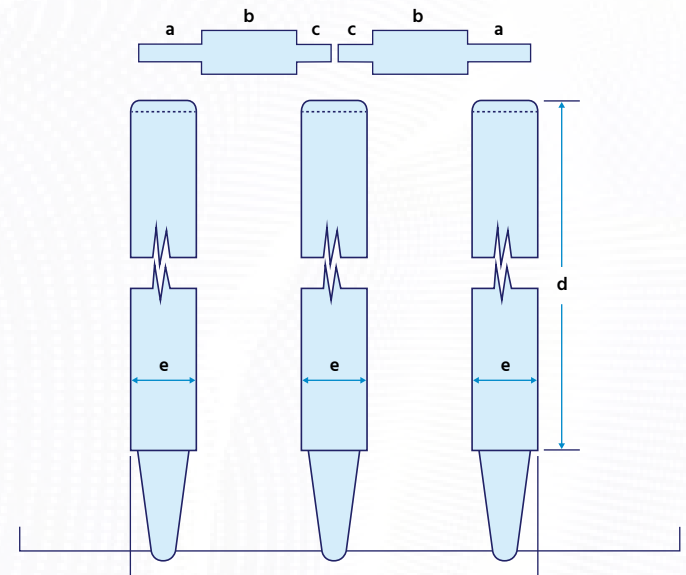

3 WICKET-KEEPING GLOVES

- 3.1 The images below illustrate the requirements of clause 27.2 in relation to:
- no webbing between the fingers;
 - a single piece of non-stretch material between finger and thumb as a means of support; and
 - when a hand wearing the glove has the thumb fully extended, the top edge being taut and not protruding beyond the straight line joining the top of the index finger to the top of the thumb.
- 3.2 Note also the requirement for wicket-keeping gloves to comply with the Clothing and Equipment Regulations in relation to the size and position of marks and logos.



APPENDIX C

THE VENUE

1 THE PITCH AND THE CREASES

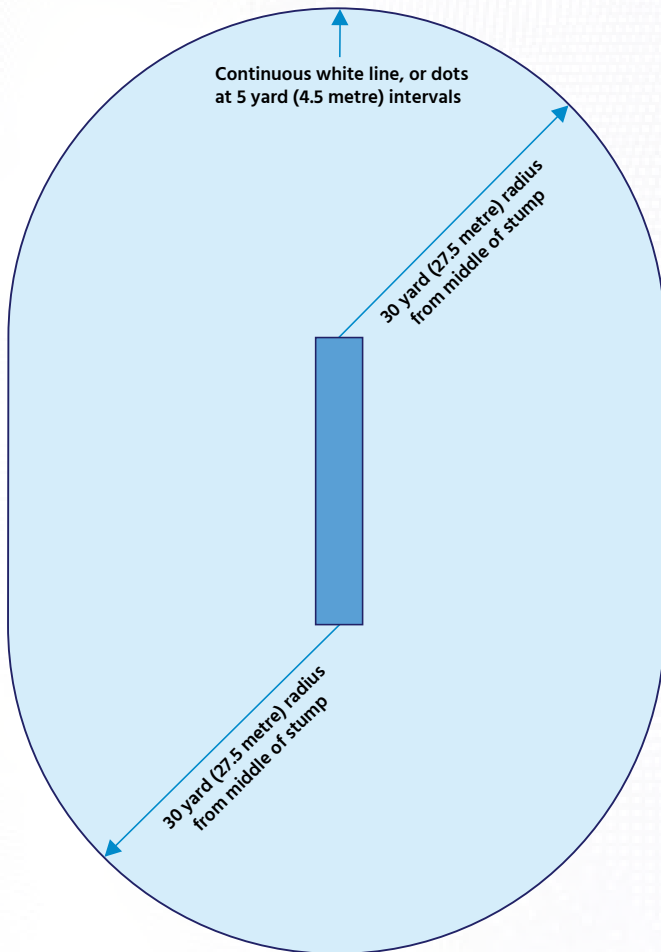

2 RESTRICTION ON THE PLACEMENT OF FIELDERS**3 ADVERTISING ON GROUNDS, PERIMETER BOARDS AND SIGHT-SCREENS****3.1 Advertising on grounds**

- 3.1.1 The logos on outfield are to be positioned as follows:
- Behind the stumps – a minimum of 25.15 yards (23 meters) from the stumps.
 - Midwicket/cover area – no advertising to be positioned within 30 yards (27.50 meters) of the centre of the pitch being used for the match.
- 3.1.2 Note: Advertising closer to the stumps as set out above which is required to meet 3D requirements for broadcasters may be permitted, subject to prior ICC approval having been obtained.

3.2 Perimeter boards

- 3.2.1 Advertising on perimeter boards placed in front of the sight-screens is permitted save that the predominant colour of such advertising shall be of a contrasting colour to that of the ball.
- 3.2.2 Advertising on perimeter boards behind the stumps at both ends shall not contain moving, flashing or flickering images and operators should ensure that the images are only changed or moved at a time that will not be distracting to the players or the umpires.
- 3.2.3 The brightness of any electronic images shall be set at a level so that it is not a distraction to the players or umpires.

3.3 Sight-screens

- 3.3.1 Sight-screens shall be provided at both ends of all grounds.
- 3.3.2 Advertising shall be permitted on the sight-screen behind the striker, providing it is removed for the subsequent over from that end.
- 3.3.3 Such advertising shall not contain flashing or flickering images and particular care should be taken by the operators that the advertising is not changed at a time which is distracting to the umpire.

4 MARKINGS ON OUTFIELD

With the permission of the Ground Authority, a bowler may use paint to make a small marking on the outfield for the purposes of identifying their run-up. Paint used for this purpose shall be any colour other than white.

APPENDIX D

DECISION REVIEW SYSTEM (DRS) AND THIRD UMPIRE PROTOCOL

1 GENERAL

1.1 Minimum requirements for use of DRS and appointment of third umpire:

- 1.1.1 Save with the express written consent of the ICC General Manager – Cricket, the Home Board shall ensure the live television broadcast of all ODI matches played in its country.
- 1.1.2 Where matches are broadcast, the camera specification set out below shall be mandatory as a minimum requirement.

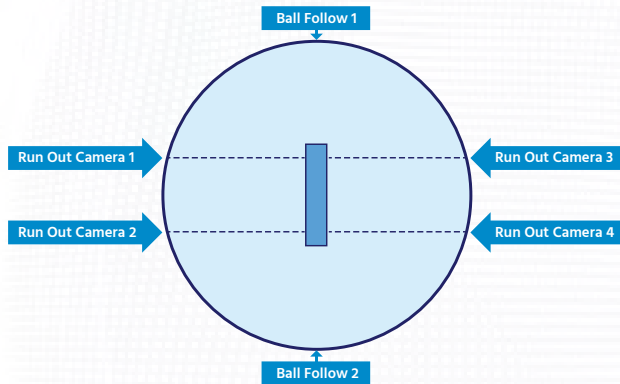

- 1.1.3 Where the camera specification set out above is provided, a third umpire shall be appointed to the match.
- 1.1.4 The provisions of paragraphs 1.1.1, 1.1.2, and 1.1.3 above shall not apply for matches between a Full Member country and Associate Member countries (whose matches have been granted ODI status) and for matches between such Associate Member countries.
- 1.1.5 If the minimum requirements for DRS to be used are satisfied, both participating Boards may agree to employ the DRS for an ODI. Otherwise, the third umpire shall be appointed and empowered to use broadcast replays to make decisions that are referred to him/her in accordance with paragraph 2 (Umpire Reviews).

- 1.1.6 The table below summarises the minimum requirements for DRS to be used, and the regulations around the appointment of the third umpire:

	THIRD UMPIRE (NON-DRS)	DRS
Minimum Requirement	Cameras Specification detailed in paragraph 1.1.2.	Cameras – Specification detailed in paragraph 1.1.2. Technology. – Approved ball-tracking technology. – Approved sound-based edge detection technology.
Third Umpire Appointment	Appointed by Home Board. From the home country. From ICC Elite Panel or International Panel of umpires.	Appointed by the ICC. Not from the same country as either of the participating teams. From ICC Elite Panel or International Panel of umpires.
Third Umpire Jurisdiction	Umpire Reviews only.	Umpire Reviews and Player Reviews.
Replays that can be used	The third umpire shall only have access to replays of any camera images. Other technology which may be in use by the broadcaster for broadcast purposes (for example, ball-tracking technology, sound-based edge detection technology, and heat-based edge detection technology) shall not be used during Umpire Reviews.	Any replay, stump microphone audio or technology detailed in paragraph 3.8.1 below.
ICC Technical Officer	Not required.	The ICC shall appoint an independent technology expert (ICC Technical Officer) to be present at every series in which the DRS is used to assist the third umpire and to protect the integrity of the DRS process.

- 1.1.7 The Home Board shall ensure that a separate room is provided for the third umpire and that he/she has access to the television equipment and technology (where DRS is used) so as to be in the best position to facilitate the referral and/or consultation processes referred to in paragraphs 2 (Umpire Review) and 3 (Player Review) below.

2 UMPIRE REVIEW

In the circumstances detailed in paragraphs 2.1, 2.2, 2.3 and 2.4 below, the on-field umpire shall have the discretion to refer the decision to the third umpire or, in the case of paragraphs 2.2, and 2.4, to consult with the third umpire before making the decision.

Save for requesting the umpire to review his/her decision under paragraph 3 (Player Review) below, players may not appeal to the on-field umpires to use the Umpire Review. Breach of this provision may constitute dissent and the player may be subject to disciplinary action under the ICC Code of Conduct for Players and Player Support Personnel.

2.1 Run Out, Stumped, Bowled and Hit Wicket Decisions

- 2.1.1 The relevant on-field umpire shall be entitled to refer an appeal for run-out, stumped, bowled or hit wicket to the third umpire.
- 2.1.2 An on-field umpire wishing to refer a decision to the third umpire shall signal to the third umpire by making the shape of a TV screen with his/her hands.
- 2.1.3 In the case of a referral of a bowled, hit wicket or stumped decision, the third umpire shall first check the fairness of the delivery (all modes of No ball except for the bowler using an Illegal Bowling Action, subject to the proviso that the third umpire may review whether the bowler has used a prohibited Specific Variation under Article 6.2 of the Illegal Bowling Regulations). If the delivery was not a fair delivery the third umpire shall indicate that the batsman is Not out and advise the on-field umpire to signal No ball. See also paragraph 2.5 below.
- 2.1.4 Additionally, if the third umpire finds the batsman is Out by another mode of dismissal (excluding LBW), or Not out by any mode of dismissal (excluding LBW), he/she shall notify the on-field umpire so that the correct decision is made.
- 2.1.5 If the third umpire decides that the batsman is Out, a red light shall be displayed; if the third umpire decides that the batsman is Not out, a green light shall be displayed. Should the third umpire be temporarily unable to respond, a white light (where available) shall remain illuminated throughout the period of interruption to signify to the on-field umpires that Umpire Reviews are temporarily unavailable, in which case the decision shall be taken by the on-field umpire. As an alternative to the red/green light system, the replay screen (where available) may be used for the purpose of conveying the third umpire's decision, in line with the ICC Big Screen Policy.

2.2 Caught Decisions, Obstructing the Field

- 2.2.1 Where the bowler's end umpire is unable to decide upon a Fair Catch or a Bump Ball, or if, on appeal from the fielding side, the batsman obstructed the field, he/she shall first consult with the striker's end umpire.
- 2.2.2 Should both on-field umpires require assistance from the third umpire to make a decision, the bowler's end umpire shall firstly take a decision on-field after consulting with the striker's end umpire, before consulting by two-way radio with the third umpire. Such consultation shall be initiated by the bowler's end umpire to the third umpire by making the shape of a TV screen with his/her hands, followed by a Soft Signal of Out or Not out made with the hands close to the chest at chest height. If the third umpire advises that the replay evidence is inconclusive, the on-field decision communicated at the start of the consultation process shall stand.
- 2.2.3 The third umpire shall determine whether the batsman has been caught, whether the delivery was a Bump Ball, or if the batsman obstructed the field. However, in reviewing the television replay(s), the third umpire shall first check the fairness of the delivery for all decisions involving a catch (all modes of No ball except for the bowler using an Illegal Bowling Action, subject to the proviso that the third umpire may review whether the bowler has used a prohibited Specific Variation under Article 6.2 of the Illegal Bowling Regulations) and whether the batsman has hit the ball. If the delivery was not a fair delivery or if it is clear to the third umpire that the batsman did not hit the ball he/she shall indicate to the bowler's end umpire that the batsman is Not out caught, and in the case of an unfair delivery, advise the bowler's end umpire to signal No ball. See also paragraph 2.5 below. Additionally, if it is clear to the third umpire that the batsman is Out by another mode of dismissal (excluding LBW), or Not out by any mode of dismissal (excluding LBW), he/she shall notify the bowler's end umpire so that the correct decision can be made.
- 2.2.4 The third umpire shall communicate his/her decision as set out in paragraph 2.1.5.

2.3 Boundary Decisions

- 2.3.1 The bowler's end umpire shall be entitled to refer to the third umpire for a decision on:
 - 2.3.1.1 whether a four or six has been scored;
 - 2.3.1.2 whether a fielder had any part of his person in contact with the ball when he touched the boundary; or
 - 2.3.1.3 whether the fielder had any part of his person in contact with the ball when he had any part of his person grounded beyond the boundary.
- 2.3.2 A decision shall be made immediately and cannot be changed thereafter.

- 2.3.3 If the television evidence is inconclusive as to whether or not a boundary has been scored, the default presumption shall be in favour of no boundary being awarded.
- 2.3.4 Where the bowler's end umpire wishes to use the assistance of the third umpire in this circumstance, he/she shall communicate with the third umpire by use of a two-way radio and the third umpire shall convey his decision to the bowler's end umpire by the same method.
- 2.3.5 The third umpire may initiate contact with the on-field umpire by two-way radio if TV coverage shows a boundary line infringement or incident that appears not to have been acted upon by the on-field umpires.

2.4 Batsmen Running to the Same End

- 2.4.1 Where both batsmen have run to the same end and the on-field umpires are uncertain over which batsman made his ground first, the on-field umpires may consult with the third umpire.
- 2.4.2 The procedure set out in paragraph 2.3.4 shall apply.

2.5 No Balls

- 2.5.1 If the bowler's end umpire is uncertain as to the fairness of the delivery following a dismissal, either affecting the validity of the dismissal or which batsman is dismissed, he/she shall be entitled to request the batsman to delay leaving the field and to check the fairness of the delivery with the third umpire. Communication with the third umpire shall be by two-way radio.
- 2.5.2 The third umpire shall check all modes of No ball except for the bowler using an Illegal Bowling Action (subject to the proviso that the third umpire may review whether the bowler has used a prohibited Specific Variation under Article 6.2 of the Illegal Bowling Regulations). The third umpire shall apply clause 21.5 when deciding whether a No ball should have been called (and must therefore be satisfied that none of the three conditions in clause 21.5 have been met before calling a No ball).
- 2.5.3 If the delivery was not a fair delivery, the bowler's end umpire shall indicate that the batsman is Not out and signal No ball (except in the case of a dismissal for obstructing the field, which may still be effected despite a No ball being called, in which case the bowler's end umpire shall indicate that the relevant batsman is Out and additionally call a No ball).
- 2.5.4 If a No ball is called following the check by the third umpire, the batting side shall benefit from the reversal of the dismissal and the one run for the No ball, but shall not benefit from any runs that may subsequently have accrued from the delivery had the on-field umpire originally called a No ball. Where the batsmen crossed while the ball was in the air before being caught, the batsmen shall remain at the same ends as if the striker had been dismissed, but no runs shall be credited to the striker even if one (or more) runs were completed prior to the catch being taken.

2.6 Cameras On or Over the Field of Play

- 2.6.1 The on-field umpires shall be entitled to refer to the third umpire for a decision as to whether the ball has at any time during the normal course of play come into contact with any part of the camera, its apparatus or its cables above the playing area, as contemplated in clause 20.1.3.
- 2.6.2 Where an on-field umpire wishes to use the assistance of the third umpire in this circumstance, he/she shall communicate with the third umpire by use of a two-way radio and the third umpire shall convey his/her decision to the bowler's end umpire by the same method.
- 2.6.3 A decision shall be made immediately and cannot be changed thereafter. If the television evidence is inconclusive as to whether or not the ball has come into contact with any part of the camera, its apparatus or its cables above the playing area, the default presumption shall be in favour of no contact having been made.
- 2.6.4 The third umpire may initiate contact with the on-field umpire by two-way radio if TV coverage shows the ball to have been in contact with any part of the camera or its cables above the playing area as envisaged under this paragraph.

3 PLAYER REVIEW

The following paragraphs shall operate in addition to and in conjunction with paragraph 2 (Umpire Review).

3.1 Circumstances in which a Player Review may be requested

- 3.1.1 A player may request a review of any decision taken by the on-field umpires concerning whether or not a batsman is dismissed, with the exception of 'Timed Out' (Player Review).
- 3.1.2 No other decisions made by the umpires are eligible for a Player Review with the exception of Fair Catch/Bump Ball (even after the third umpire has been consulted and the decision communicated).
- 3.1.3 Only the batsman involved in a dismissal may request a Player Review of an Out decision and only the captain (or acting captain) of the fielding team may request a Player Review of a Not out decision.
- 3.1.4 A decision concerning whether or not a batsman is dismissed that could have been the subject of a Umpire Review under paragraph 2 is eligible for a Player Review as soon as it is clear that the on-field umpire has chosen not to initiate the Umpire Review.

3.2 The manner of requesting the Player Review

- 3.2.1 The request shall be made by the player making a 'T' sign with both forearms at head height.
- 3.2.2 The total time elapsed between the ball becoming dead and the review request being made shall be no more than 15 seconds. The only exception permitted shall be when an Umpire Review for Fair Catch or Bump Ball (as permitted in paragraph 2.2 above) is required to answer an appeal for a caught decision, in which case either team is able to request a Player Review of that caught

decision within 15 seconds of the decision being communicated. The bowler's end umpire shall provide the relevant player with a prompt after 10 seconds if the request has not been made at that time and the player shall request the review immediately thereafter. If the on-field umpires believe that a request has not been made within the 15 second time limit, they shall decline the request for a Player Review.

- 3.2.3 The captain may consult with the bowler and other fielders, and the two batsmen may consult with each other prior to deciding whether to request a Player Review. Under no circumstances is any player permitted to query an umpire about any aspect of a decision before deciding on whether or not to request a Player Review. If the on-field umpires believe that the captain or either batsman has received direct or indirect input emanating other than from the players on the field, then they may at their discretion decline the request for a Player Review. In particular, signals from the dressing room must not be given.
- 3.2.4 No replays, either at normal speed or slow motion, shall be shown on a big screen to spectators until the 15 second time limit allowed for requesting a Player Review has elapsed. The only exception to this provision is where a Player Review of a caught decision is requested after the Umpire Review of a Fair Catch or Bump Ball has concluded, as detailed in paragraph 3.2.2 above (due to the fact that replays may have been shown on the big screen during that Umpire Review process).
- 3.2.5 Where either on-field umpire initiates an Umpire Review, this does not preclude a player seeking a Player Review of a separate incident from the same delivery. The request for a Player Review may be made after the Umpire Review, provided the request is still within the 15 second time limit described in paragraph 3.2.2 above. (See paragraphs 3.9.2 and 3.9.3 below for the process for addressing both an Umpire and Player Review).
- 3.2.6 A request for a Player Review cannot be withdrawn once it has been made.

3.3 The process of consultation

- 3.3.1 On receipt of an eligible and timely request for a Player Review, the relevant on-field umpire shall make the sign of a shape of a TV screen with his/her hands in the normal way.
- 3.3.2 The relevant on-field umpire shall initiate communication with the third umpire by confirming;
- 3.3.2.1 That a Player Review has been requested,
- 3.3.2.2 The mode of dismissal for which the relevant on-field umpire adjudicated the appeal,
- 3.3.2.3 The decision that has been made (Out or Not out), and;
- 3.3.2.4 For LBW appeals, where relevant, if the bowler's end umpire believed that the striker made no genuine attempt to play the ball with the bat (the default presumption of the third umpire in the absence of any information on this point from the bowler's end umpire shall be that a genuine attempt to play the ball with the bat was made).

- 3.3.3 A two-way consultation process shall begin to investigate whether there is anything that the third umpire can see or hear which would indicate that the on-field umpire should change his/her original decision.
- 3.3.4 The third umpire shall not withhold any factual information which may help in the decision making process. In particular, in reviewing a dismissal, if the third umpire believes that the batsman may instead be Out by any other mode of dismissal, he/she shall advise the on-field umpire accordingly. The process of consultation described in this paragraph in respect of such other mode of dismissal shall then be conducted as if the batsman has been given Not out.
- 3.3.5 The third umpire shall initially check all modes of No ball except for the bowler using an Illegal Bowling Action (subject to the proviso that the third umpire may review whether the bowler has used a prohibited Specific Variation under Article 6.2 of the Illegal Bowling Regulations), where appropriate advising the on-field umpire accordingly.
- 3.3.6 If despite the available technology, the third umpire is unable to decide with a high degree of confidence whether the original on-field decision should be changed, then he/she shall report that the replays are 'inconclusive', and that the on-field decision shall stand. The third umpire shall not give answers conveying likelihoods or probabilities.
- 3.3.7 In circumstances where the television technology (all or parts thereof) is not available to the third umpire or fails for whatever reason, the third umpire shall advise the on-field umpire of this fact but still provide any relevant factual information that may be ascertained from the available television replays and other technology.
- 3.3.8 The on-field umpire shall then make his/her decision based on the information provided by the third umpire, any other factual information offered by the third umpire and his/her recollection and opinion of the original incident.
- 3.3.9 The on-field umpire shall reverse his/her decision if the nature of the supplementary information received from the third umpire leads him/her to conclude that his/her original decision was incorrect.

3.4 Review of LBW Decisions

- 3.4.1 In assessing whether a batsman is Out LBW in accordance with clause 36, the third umpire shall first judge whether the delivery is fair (as set out in clause 36.1.1), and second, whether or not the ball has touched the bat before being intercepted by any part of the striker's person (as set out in clause 36.1.3).

3.4.2 If the batsman is still eligible to be Out, the ball-tracking technology shall then present three pieces of information to the third umpire relating to the path of the ball:

3.4.2.1 The point of pitching (where applicable) (PITCHING).

3.4.2.2 The position of the ball at the point of first interception (IMPACT).

3.4.2.3 Whether the ball would have hit the wicket (WICKET).

3.4.3 This Decision Review System (DRS) and Third Umpire Protocol includes a category of Umpire's Call, which shall be the conclusion reported where the technology indicates a marginal decision in respect of either the point of first interception or whether the ball would have hit the stumps.

3.4.4 PITCHING

3.4.4.1 The interpretation of "pitches in line between wicket and wicket" in clause 36.12 shall refer to the position of the centre of the ball at the point of pitching, in relation to the Pitching Zone.

3.4.4.2 The Pitching Zone is defined as a two dimensional area on the pitch between both sets of stumps with its boundaries consisting of the base of both sets of stumps and a line between the outside of the outer stumps at each end.

3.4.4.3 Where applicable, the ball-tracking technology shall report that the ball pitched in one of the following three areas in relation to the Pitching Zone:

In Line	The centre of the ball was inside the Pitching Zone
Outside Off	The centre of the ball was outside, and to the off side of, the Pitching Zone
Outside Leg	The centre of the ball was outside, and to the leg side of, the Pitching Zone

3.4.4.4 Subject to the satisfaction of the other elements of clause 36, the batsman can be Out if the ball-tracking technology reports that the ball pitched Outside Off or In Line, but the batsman shall be Not out if the ball pitched Outside Leg.

3.4.5 IMPACT

3.4.5.1 The interpretation of "the (first) point of impact, even if in above the level of the bails, is between wicket and wicket" in clause 36.14 shall refer to the position of the ball at the point of first interception, in relation to the Impact Zone.

3.4.5.2 The Impact Zone is defined as a three dimensional space extending between both wickets to an indefinite height and with its boundaries consisting of a line between the outside of the outer stumps at each end.

3.4.5.3 The ball-tracking technology shall report that the point of first interception was in one of the following categories in relation to the Impact Zone:

In Line	The centre of the ball was inside the Impact Zone.
Umpire's Call	Some part of the ball was inside the Impact Zone, but the centre of the ball was outside the Impact Zone, with the further sub-category of 'Umpire's Call (off side)' where the centre of the ball was to the off side of the Impact Zone and the bowler's end umpire communicates to the third umpire that no genuine attempt to play the ball was made by the batsman.
Outside	No part of the ball was inside the Impact Zone, with the further sub-categories of 'Outside (off)' and 'Outside (leg)' to indicate the location of the point of first interception in relation to the Impact Zone when the bowler's end umpire communicates to the third umpire that no genuine attempt to play the ball was made by the batsman.

3.4.5.4 Where a Not out decision is being reviewed, and it is judged that the batsman has made a genuine attempt to play the ball, the ball-tracking technology must report that the point of first interception was In Line for the batsman to be eligible to be given Out, otherwise the batsman shall remain Not out.

3.4.5.5 Where a Not out decision is being reviewed, and it is judged that the batsman has made no genuine attempt to play the ball, the ball-tracking technology must report that the point of impact was In Line, or Umpire's Call (off side), or Outside (off) for the batsman to be eligible to be given Out, otherwise the batsman shall remain Not out.

3.4.5.6 Where an Out decision is being reviewed, and it is judged that the batsman has made a genuine attempt to play the ball, the ball-tracking technology must report that the point of first interception was Outside for the decision to be reversed to Not out, otherwise the batsman shall remain eligible to be given Out.

- 3.4.5.7 Where an Out decision is being reviewed, and it is judged that the batsman has made no genuine attempt to play the ball, the ball-tracking technology must report that the point of first interception was Outside (leg) for the decision to be reversed to Not out, otherwise the batsman shall remain eligible to be given Out.

3.4.6 WICKET

- 3.4.6.1 The interpretation of whether “the ball would have hit the wicket” in clause 36.15 shall refer to position of the ball as it either hits or passes the wicket, in relation to the Wicket Zone.
- 3.4.6.2 The Wicket Zone is defined as a two dimensional area whose boundaries are the outside of the outer stumps, the base of the stumps and the bottom of the bails.
- 3.4.6.3 The ball-tracking technology shall report whether the ball would have hit the wicket with reference to the following three categories:

Hitting	The ball was hitting the wicket, and the centre of the ball was inside the Wicket Zone.
Umpire's Call	The ball was hitting the wicket, but the centre of the ball was not inside the Wicket Zone.
Missing	The ball was missing the wicket.

- 3.4.6.4 Where a Not out decision is being reviewed, the ball-tracking technology must report that the ball was Hitting for the batsman to be eligible to be given Out, otherwise the batsman shall remain Not out.

However, where the evidence shows that the ball was Hitting, the point of first interception was In Line, and the ball pitched In Line or Outside Off, but that:

- The point of first interception was 300cm or more from the stumps; or
- The point of first interception was more than 250cm but less than 300cm from the stumps and the distance between the point of pitching and the point of first interception was less than 40cm,

the on-field decision shall stand (that is, Not out).

- 3.4.6.5 Where an Out decision is being reviewed, the ball-tracking technology must report that the ball was Missing for the on-field decision to be reversed to Not out, otherwise the batsman shall remain eligible to be given Out.

- 3.4.7 When the ball strikes the batsman on the full, and the evidence provided by the ball-tracking technology indicates that the ball would have pitched before striking or passing the wicket, there will be no information available from that delivery that will allow the ball-tracking technology to accurately predict the height of the ball after pitching.

- 3.4.8 With regard to determining whether the ball would have hit the wicket under these circumstances, the ball-tracking technology shall project the line of the ball in accordance with clause 36.2.3 (it is to be assumed that the path of the ball before interception would have continued after interception, irrespective of whether the ball might have pitched subsequently or not), and display the simulated path of the ball from directly above the wicket.
- 3.4.9 The third umpire shall advise the bowler's end umpire only on the point of first interception and whether the ball would have hit the stumps (in line with the process set out in paragraph 3.4 above), but shall make no comment on the predicted height of the ball after pitching, which shall remain a judgment of the bowler's end umpire.

3.5 The process for communicating the final decision

- 3.5.1 For Player Reviews concerning potential dismissals, the relevant on-field umpire shall indicate Out by raising his/her finger above his/her head in a normal yet prominent manner or indicate Not out by the call of 'not out' and by crossing his/her hands in a horizontal position side to side in front and above his/her waist three times. Where the decision is a reversal of the on-field umpire's previous decision, he/she shall make the 'revoke last signal' indication immediately prior to the above.
- 3.5.2 If the mode of dismissal is not obvious or not the same as that on which the original decision was based, then the umpire shall advise the scorers via the third umpire.

3.6 Number of Player Review requests permitted

- 3.6.1 In each innings, each team shall be allowed to make a maximum of one Player Review request that is categorised as 'Unsuccessful' (as set out in paragraph 3.6.3 below).
- 3.6.2 Where a request for a Player Review results in the original on-field decision being reversed, then the Player Review shall be categorised as 'Successful' and shall not count towards the innings limit.
- 3.6.3 Where a request for a Player Review results in the original on-field decision remaining unchanged (other than in the circumstances set out in paragraphs 3.6.4, 3.6.6 or 3.6.8), the Player Review shall be categorised as 'Unsuccessful'.
- 3.6.4 Where a request for a Player Review of an LBW decision results in the on-field decision remaining unchanged solely on the basis of an Umpire's Call, the Player Review shall be categorised as 'Unchanged – Umpire's Call'. A Player Review categorised as 'Unchanged – Umpire's Call' shall not count towards the innings limit set out in paragraph 3.6.1.
- 3.6.5 Where, following a request for a Player Review, the original on-field decision of Out is unchanged, but for a different mode of dismissal from the original on-field decision, then the Player Review shall still be categorised as 'Unsuccessful'.

- 3.6.6 Where, following a request for a Player Review, the original on-field decision of Not out is unchanged on account of the delivery being a No ball (for any reason), thereby not requiring any further evaluation, the Player Review shall not be counted as 'Unsuccessful' and accordingly shall not count towards the innings limit set out in paragraph 3.6.1.
- 3.6.7 Where a Player Review and an Umpire Review are requested from the same delivery and the decision of the third umpire from the Umpire Review renders the Player Review unnecessary (see paragraphs 3.9.2 and 3.9.3), the Player Review request shall be disregarded and accordingly shall not count towards the innings limit set out in paragraph 3.6.1.
- 3.6.8 A Player Review categorised as 'Unsuccessful' may be reinstated by the ICC Match Referee at his/her sole discretion (if appropriate after consultation with the ICC Technical Official and/or the television broadcast director) if the Player Review could not properly be concluded due to a failure of the technology. Any such decision shall be final and shall be taken as soon as possible, being communicated to both teams once all the relevant facts have been ascertained by the ICC Match Referee. A Player Review categorised as 'Unsuccessful' shall not be reinstated if, despite any technical failures, the correct decision could still have been made using the other available technology. Similarly, a Player Review categorised as 'Unsuccessful' shall not be reinstated where the technology worked as intended, but the evidence gleaned from its use was inconclusive.
- 3.6.9 The third umpire shall be responsible for counting the number Player Reviews categorised as 'Unsuccessful' and shall advise the on-field umpires once either team has exhausted their allowance for the innings.
- 3.6.10 The scoreboard shall display, for the innings in progress, the number of Player Reviews remaining available to each team.

CATEGORY OF PLAYER REVIEW	OUTCOME OF PLAYER REVIEW	CONSEQUENCE OF PLAYER REVIEW
Successful (paragraph 3.6.2)	On-field decision reversed	Does not count towards innings limit set out in paragraph 3.6.1
Unsuccessful (paragraphs 3.6.3 and 3.6.5)	On-field decision unchanged	Counts towards innings limit set out in paragraph 3.6.1
Unchanged – Umpire's Call (paragraph 3.6.4)	On-field decision unchanged	Does not count towards innings limit set out in paragraph 3.6.1
No ball – no evaluation required (paragraph 3.6.6)	On-field decision unchanged	Does not count towards innings limit set out in paragraph 3.6.1
Failure of technology (paragraph 3.6.8)	On-field decision unchanged	Does not count towards innings limit set out in paragraph 3.6.1

3.7 Dead ball

- 3.7.1 If following a Player Review request, an original decision of Out is changed to Not out, then the ball is still deemed to have become dead when the original decision was made (as per clause 20.1.1.3). The batting side, while benefiting from the reversal of the dismissal, shall not benefit from any runs that may subsequently have accrued from the delivery had the on-field umpire originally made a Not out decision, other than any No ball penalty that could arise under paragraph 3.3.5 above.
- 3.7.2 If an original decision of Not out is changed to Out, the ball shall retrospectively be deemed to have become dead from the moment of the dismissal event. All subsequent events, including any runs scored, shall be ignored.

3.8 Use of technology

- 3.8.1 The following technology may be used by the third umpire during a Player Review:
- 3.8.1.1 Replays, at any speed, from any available broadcast camera
- 3.8.1.2 Sound from the stump microphones with the replays at normal speed and slow motion
- 3.8.1.3 Approved ball-tracking technology:
- HawkEye (HawkEye Innovations), or;
 - VirtualEye (ARL)
- 3.8.1.4 Approved sound-based edge detection technology:
- Real-Time Snickometer (BBG Sports), or;
 - UltraEdge (HawkEye Innovations)
- 3.8.1.5 Approved heat-based edge detection technology:
- Hot Spot cameras (BBG Sports)
- 3.8.1.6 LED Wickets (using the lights to indicate if the wicket is broken, as set out in paragraph 4.2):
- Zing Bails and Stumps
- 3.8.2 In addition, other forms of technology may be used subject to the ICC being satisfied that the required standards of accuracy and time efficiency can be met.
- 3.8.3 Where practical usage or further testing indicates that any of the above forms of technology cannot reliably provide accurate and timely information, then it may be removed prior to or during a match. The final decision regarding the technology to be used in a given match shall be taken by the ICC Match Referee in consultation with the ICC Technical Official, ICC management and the competing teams' governing bodies.

3.9 Combining Umpire Review with Player Review

- 3.9.1 If an Umpire Review (under paragraph 2) and a request for a Player Review (under paragraph 3) are made following the same delivery but relating to separate modes of dismissal, the following process shall apply.
- 3.9.2 The Umpire Review shall be carried out prior to the Player Review if all of the following conditions apply:
- 3.9.2.1 The Player Review has been requested by the fielding side.
- 3.9.2.2 The Umpire Review and the Player Review both relate to the dismissal of the same batsman.
- 3.9.2.3 If the batsman is out, the number of runs scored from the delivery would be the same for both modes of dismissal.
- 3.9.2.4 If the batsman is out, the batsman on strike for the next delivery would be the same for both modes of dismissal.
- 3.9.3 If the Umpire Review leads the third umpire to make a decision of Out, then this shall be displayed in the usual manner and the Player Review shall not be undertaken. If the Umpire Review results in a Not out decision, then the third umpire shall make no public decision but shall proceed to address the request for a Player Review.
- 3.9.4 For illustration, following an LBW appeal which is given Not out by the bowler's end umpire, the striker sets off for a run, is sent back and there is an appeal for his run out. The players request that the LBW decision is reviewed and the umpires request that the run out be reviewed. The four criteria above are satisfied, so the run out referral is determined first. Should the appeal for run out be Out, then there is no requirement for the LBW review to take place.
- 3.9.5 In all other circumstances, the incidents shall be addressed in chronological order. If the conclusion from the first incident is that a batsman is dismissed, then the ball would be deemed to have become dead at that point, rendering investigation of the second incident unnecessary.

4 INTERPRETATION OF PLAYING CONDITIONS

- 4.1 When using a replay to determine the moment at which the wicket has been put down (as per clause 29.1), the third umpire shall deem this to be the first frame in which one of the bails is shown (or can be deduced) to have lost all contact with the top of the stumps and subsequent frames show the bail permanently removed from the top of the stumps.
- 4.2 Where LED Wickets are used (as provided for in paragraph 3.8.1.6) the moment at which the wicket has been put down (as per clause 29.1) shall be deemed to be the first frame in which the LED lights are illuminated and subsequent frames show the bail permanently removed from the top of the stumps.

APPENDIX E**CALCULATIONS****Table 1: Calculation sheet for use when a delay or interruptions occur in the First Innings**

Time	
Net playing time available at start of the match	420 minutes (A)
Time innings in progress	_____ (B)
Playing time lost	_____ (C)
Extra time available	_____ (D)
Time made up from reduced interval	_____ (E)
Effective playing time lost [C - (D + E)]	_____ (F)
Remaining playing time available (A - F)	_____ (G)
G divided by 4.2 (to 2 decimal places)	_____ (H)
Max overs per team [H/2] (round up fractions)	_____ (I)
Maximum overs per bowler [I/5]	_____
Duration of Powerplay Overs (Initial, batting side)	_____ + _____
Rescheduled Playing Hours	
First session to commence or recommence	_____ (J)
Length of innings [I x 4.2] (round up fractions)	_____ (K)
Rescheduled first innings cessation time [J + (K - B)]	_____ (L)
Length of interval	_____ (M)
Second innings commencement time [L + M]	_____ (N)
Rescheduled second innings cessation time [N + K]	_____ *(O)

* Ensure that the match is not finishing earlier than the original or rescheduled cessation time by applying clause 13.7.2. If so, add at least one over to each team and recalculate (I) to (O) above to prevent this from happening.

Table 2: Calculation sheet to check whether an interruption during the First Innings should terminate the innings

Proposed re-start time	_____	(P)
Rescheduled cut-off time allowing for full use of any extra time provision	_____	(Q)
Minutes between P and Q	_____	(R)
Potential overs to be bowled $[R/4.2]$ (round up fractions)	_____	(S)
Number of complete overs faced to date in first innings	_____	(T)
If S is greater than T then revert to Table 1		
If S is less than or equal to T then the first innings is terminated – go to Table 3		

Table 3: Calculation sheet for the start of the Second Innings

Maximum overs to be bowled:

(If first innings was terminated, S from Table 2)	_____	(A)
Scheduled length of innings: $[A \times 4.2]$ (round up fractions)	_____	(B)
Start time	_____	(C)
Scheduled cessation time $[C + B]$	_____	(D)

Overs per bowler and fielding restrictions

Maximum overs per bowler $[A/5]$	_____	overs
Duration of Powerplay overs (initial, batting side)	_____ + _____	overs

Table 4: Calculation sheet for use when interruption occurs after the start of the Second Innings

Time

Time at start of innings	_____	(A)
Time at start of interruption	_____	(B)
Time innings in progress	_____	(C)
Restart time	_____	(D)
Length of interruption $[D - B]$	_____	(E)
Additional time available:	_____	(F)
(Any unused provision for 'Extra Time' or for earlier than scheduled start of second innings)		
Total playing time lost $[E - F]$	_____	(G)

Overs

Maximum overs at start of innings	_____	(H)
Overs lost $[G/4.2]$ (rounded down)	_____	(I)
Adjusted maximum length of innings $[H - I]$	_____	(J)
Rescheduled length of innings $[J \times 4.2]$ rounded up	_____	(K)
Amended cessation time of innings $[D + (K - C)]$	_____	(L)

Overs per bowler and Fielding Restrictions

Maximum overs per bowler $[J/5]$	_____	overs
Duration of Powerplay overs (initial, batting side)	_____ + _____	overs

APPENDIX F

APPLICATION OF THE RESERVE DAY

The hours of play on the Reserve Day shall be the same as on the scheduled day for the match (including the extra time provision).

If play is interrupted on the scheduled day, the umpires shall use the available extra time and, if necessary, reduce the number of overs to try to achieve a result on that day.

Each team must have had the opportunity to bat for a minimum of 20 overs for a result to be achieved. If play has not resumed by the cut-off time required to allow the minimum number of overs to be bowled to achieve a result on the scheduled day, play shall be abandoned for the day and the Reserve Day shall be used to complete the match.

On the Reserve Day, play shall recommence under the same assumption that the last ball was bowled on the scheduled day.

The match starts when the coin toss takes place and teams are exchanged. If the toss occurs on the scheduled day and there is no play thereafter, the result of the toss and the named teams shall be carried through to the Reserve Day.

In making their decisions in relation to ground, weather and light, the umpires shall aim to maximize play on the scheduled day of the match in order to achieve a result on that day, as if there was no Reserve Day available.

The treatment of the pitch on the Reserve Day by the Ground Authority shall be as follows:

- Covering and removal of covers – as for the scheduled day of the match under clause 10 of the Playing Conditions; and
- Mowing and rolling – as for Day 2 of a Test Match, under clause 9 of the ICC Test Match Playing Conditions.

Example 1: Match starts at 50 overs per side and there is an interruption at 19 overs. Overs are reduced to 46 overs per side and play is about to resume. Before another ball is bowled it rains and play is abandoned for the day. As the match did not resume under the revised overs, the match should continue on the Reserve Day at the original 50 overs per side with the overs reduced if necessary during the Reserve Day.

Example 2: The same start as in example 1 i.e. match starts at 50 overs per side and there is an interruption at 19 overs. Overs are reduced to 46 overs per side and play is about to resume. This time, play starts and after an over has been bowled it rains and play is abandoned for the day. As the match has resumed, it is continued on the Reserve Day at 46 overs per side with the overs further reduced if necessary during the Reserve Day.

APPENDIX G

USE OF ELECTRONIC COMMUNICATIONS EQUIPMENT

The use of electronic communication devices and equipment of any kind to communicate with players on the field of play shall not be permitted.

ICC MEN'S TWENTY20 INTERNATIONAL PLAYING CONDITIONS

Effective from 1 August 2019

ICC MEN'S TWENTY20 INTERNATIONAL PLAYING CONDITIONS

CONTENTS

1	THE PLAYERS	5.3
2	THE UMPIRES	5.6
3	THE SCORERS	5.11
4	THE BALL	5.11
5	THE BAT	5.12
6	THE PITCH	5.14
7	THE CREASES	5.16
8	THE WICKETS	5.17
9	PREPARATION AND MAINTENANCE OF THE PLAYING AREA	5.18
10	COVERING THE PITCH	5.20
11	INTERVALS	5.20
12	START OF PLAY; CESSATION OF PLAY	5.21
13	INNINGS	5.23
14	THE FOLLOW-ON	5.27
15	DECLARATION AND FORFEITURE	5.27
16	THE RESULT	5.27
17	THE OVER	5.30
18	SCORING RUNS	5.31
19	BOUNDARIES	5.35
20	DEAD BALL	5.37
21	NO BALL	5.39
22	WIDE BALL	5.43
23	BYE AND LEG BYE	5.44
24	FIELDER'S ABSENCE; SUBSTITUTES	5.46
25	BATSMAN'S INNINGS	5.48
26	PRACTICE ON THE FIELD	5.49
27	THE WICKET-KEEPER	5.50
28	THE FIELDER	5.52
29	THE WICKET IS DOWN	5.55
30	BATSMAN OUT OF HIS GROUND	5.56
31	APPEALS	5.57
32	BOWLED	5.58
33	CAUGHT	5.58
34	HIT THE BALL TWICE	5.60
35	HIT WICKET	5.61
36	LEG BEFORE WICKET	5.61
37	OBSTRUCTING THE FIELD	5.62
38	RUN OUT	5.63

39	STUMPED	5.64
40	TIMED OUT	5.65
41	UNFAIR PLAY	5.65
42	PLAYERS' CONDUCT	5.78

APPENDIX A DEFINITIONS 5.82

1	The match	5.82
2	Implements and equipment	5.82
3	The playing area	5.83
4	Positioning	5.83
5	Umpires and decision-making	5.84
6	Batsmen	5.85
7	Fielders	5.86
8	Substitutes	5.86
9	Bowlers	5.86
10	The ball	5.87
11	Runs	5.87
12	The person	5.87
13	Off side / on side; in front of / behind the popping crease	5.89

APPENDIX B EQUIPMENT 5.90

1	The Bat	5.90
2	The wickets	5.93
3	Wicket-keeping gloves	5.94

APPENDIX C THE VENUE 5.95

1	The pitch and the creases	5.95
2	Restriction on the placement of fielders	5.96
3	Advertising on grounds, perimeter boards and sight-screens	5.97
4	Markings on outfield	5.97

**APPENDIX D DECISION REVIEW SYSTEM (DRS)
AND THIRD UMPIRE PROTOCOL** 5.98

1	General	5.98
2	Umpire Review	5.100
3	Player Review	5.103
4	Interpretation of Playing Conditions	5.112

APPENDIX E CALCULATIONS 5.113

APPENDIX F PROCEDURE FOR THE SUPER OVER 5.116

APPENDIX G USE OF ELECTRONIC COMMUNICATIONS EQUIPMENT 5.119

PREAMBLE

THE SPIRIT OF CRICKET

Cricket owes much of its appeal and enjoyment to the fact that it should be played not only according to the Laws (which are incorporated within these Playing Conditions), but also within the Spirit of Cricket.

The major responsibility for ensuring fair play rests with the captains, but extends to all players, match officials and, especially in junior cricket, teachers, coaches and parents.

Respect is central to the Spirit of Cricket.

Respect your captain, team-mates, opponents and the authority of the umpires.

Play hard and play fair.

Accept the umpire's decision.

Create a positive atmosphere by your own conduct, and encourage others to do likewise.

Show self-discipline, even when things go against you.

Congratulate the opposition on their successes, and enjoy those of your own team.

Thank the officials and your opposition at the end of the match, whatever the result.

Cricket is an exciting game that encourages leadership, friendship and teamwork, which brings together people from different nationalities, cultures and religions, especially when played within the Spirit of Cricket.

1 THE PLAYERS

1.1 Number of players

A match is played between two sides, each of eleven players, one of whom shall be captain.

1.2 Nomination and replacement of players

- 1.2.1 Each captain shall nominate 11 players plus a maximum of 4 substitute fielders in writing to the ICC Match Referee before the toss. Other than set out in clause 1.2.7, no player (member of the playing eleven) may be changed after the nomination without the consent of the opposing captain.
- 1.2.2 Only those nominated as substitute fielders shall be entitled to act as substitute fielders during the match, unless the ICC Match Referee, in exceptional circumstances, allows subsequent additions.
- 1.2.3 All those nominated including those nominated as substitute fielders, as well as any Concussion Replacements, must be eligible to play for that particular team and by such nomination the nominees shall warrant that they are so eligible.
- 1.2.4 In addition, by their nomination, the nominees shall be deemed to have agreed to abide by all the applicable ICC Regulations pertaining to international cricket and in particular, the Clothing and Equipment Regulations, the Code of Conduct for Players and Player Support Personnel (hereafter referred to as the ICC Code of Conduct), the Anti-Racism Code for Players and Player Support Personnel, the Anti-Doping Code and the Anti-Corruption Code.

- 1.2.5 A player or player support personnel who has been suspended from participating in a match shall not, from the toss of the coin and for the remainder of the match thereafter:
- 1.2.5.1 Be nominated as, or carry out any of the duties or responsibilities of a substitute fielder, or
- 1.2.5.2 Enter any part of the playing area (which shall include the field of play and the area between the boundary and the perimeter boards) at any time, including any scheduled or unscheduled breaks in play.
- 1.2.6 A player who has been suspended from participating in a match shall be permitted from the toss of the coin and for the remainder of the match thereafter be permitted to enter the players' dressing room provided that the players' dressing room (or any part thereof) for the match is not within the playing area described in clause 1.2.5.2 above (for example, the player is not permitted to enter the on-field 'dug-out').
- 1.2.7 If a player sustains a concussion or suspected concussion as a result of a head or neck injury during the course of the relevant match, a Concussion Replacement may be permitted in the following circumstances:
- 1.2.7.1 the head or neck injury must have been sustained during play and within the playing area described in clause 1.2.5.2 above;
- 1.2.7.2 a concussion or suspected concussion must have been formally diagnosed by the Team Medical Representative;
- 1.2.7.3 the Team Medical Representative or Team Manager shall submit a Concussion Replacement Request to the ICC Match Referee on a standard form, which shall:
- 1.2.7.3.1 identify the player who has sustained the concussion or suspected concussion;
- 1.2.7.3.2 specify the incident in which the concussion or suspected concussion was sustained, including the time at which it occurred;
- 1.2.7.3.3 confirm that, following an examination, the Team Medical Representative believes or suspects that the player has sustained a concussion as a result of the incident specified in 1.2.7.3.2 above; and
- 1.2.7.3.4 identify the requested Concussion Replacement, who shall be a like-for-like replacement for the player who has sustained the concussion or suspected concussion.
- 1.2.7.4 The Concussion Replacement Request must be submitted as soon as possible after the incident specified in 1.2.7.3.2 if a Concussion Replacement is to be permitted.

- 1.2.8 The ICC Match Referee should ordinarily approve a Concussion Replacement Request if the replacement is a like-for-like player whose inclusion will not excessively advantage his team for the remainder of the match.
- 1.2.8.1 In assessing whether the nominated Concussion Replacement should be considered a like-for-like player, the ICC Match Referee should consider the likely role the concussed player would have played during the remainder of the match, and the normal role that would be performed by the nominated Concussion Replacement.
- 1.2.8.2 If the ICC Match Referee believes that the inclusion of the nominated Concussion Replacement, when performing their normal role, would excessively advantage their team, the Match Referee may impose such conditions upon the identity and involvement of the Concussion Replacement as he/she sees fit, in line with the overriding objective of facilitating a like-for-like replacement for the concussed player.
- 1.2.8.3 The ICC Match Referee may, in reviewing a Concussion Replacement Request made in accordance with clause 1.2.7.3, request any such further information as may be required in order to make the determination required under clauses 1.2.8.1 and 1.2.8.2.
- 1.2.9 The decision of the ICC Match Referee in relation to any Concussion Replacement Request shall be final and neither team shall have any right of appeal.
- 1.2.10 Once the Concussion Replacement has been approved by the ICC Match Referee, the replaced player shall play no further part in the match.
- 1.2.11 Both the Concussion Replacement and the replaced player shall be considered to have played in the match for records and statistical purposes.
- 1.3 Captain**
- 1.3.1 If at any time the captain is not available, a deputy shall act for him.
- 1.3.2 If a captain is not available to nominate the players, then any person associated with that team may act as his deputy to do so. See clause 1.2.
- 1.3.3 At any time after the nomination of the players, only a nominated player can act as deputy in discharging the duties and responsibilities of the captain as stated in these Playing Conditions, including at the toss. See clause 13.4 (The toss).
- 1.4 Responsibility of captains**
- The captains are responsible at all times for ensuring that play is conducted within the Spirit of Cricket as well as within these Playing Conditions.

2 THE UMPIRES**2.1 Appointment and attendance**

The following rules for the selection and appointment of T20I umpires shall be followed as far as it is practicable to do so:

- 2.1.1 The umpires shall control the game as required by these Playing Conditions, with absolute impartiality and shall be present at the ground at least two hours before the scheduled start of play,
- 2.1.2 The ICC shall establish an 'Elite Panel' of umpires who shall be contracted to the ICC.
- 2.1.3 Each Full Member shall nominate from its panel of first class umpires up to four umpires to an 'International Panel'
- 2.1.4 The Home Board shall appoint both umpires to stand in each T20I match. Such umpires shall be selected from its umpires on the Elite or International Panel.
- 2.1.5 In all T20I matches, the third umpire will be appointed by the Home Board and shall act as the emergency on-field umpire and officiate in regard to TV replays. Such appointment shall be made from the 'Elite Panel' or the 'International Panel'.
 - 2.1.5.1 The playing conditions governing the use of the DRS and the third umpire are included in Appendix D.
- 2.1.6 The Home Board shall also appoint a fourth umpire for each T20I match from its panel of first class umpires. The fourth umpire shall act as the emergency third umpire. In 'DRS' T20I matches the fourth umpire shall be appointed from the "International Panel"
- 2.1.7 The ICC shall appoint the match referee for all matches (ICC Match Referee).
- 2.1.8 The ICC Match Referee shall not be from the same country as the participating teams.
- 2.1.9 Neither team will have a right of objection to the appointment of any umpire or match referee.

2.2 Change of umpire

An umpire shall not be changed during the match, other than in exceptional circumstances, unless he/she is injured or ill.

2.3 Consultation with Home Board

Before the match the umpires shall consult with the Home Board to determine;

- 2.3.1 the balls to be used during the match. See clause 4 (The ball).
- 2.3.2 the hours of play and the times and durations of any agreed intervals.
- 2.3.3 which clock or watch and back-up time piece is to be used during the match.
- 2.3.4 the boundary of the field of play. See clause 19 (Boundaries).
- 2.3.5 the use of covers. See clause 10 (Covering the pitch).
- 2.3.6 any special conditions of play affecting the conduct of the match. Inform the scorers of agreements in 2.3.2, 2.3.3, 2.3.4 and 2.3.6.

2.4 The wickets, creases and boundaries

Before the toss and during the match, the umpires shall satisfy themselves that

- 2.4.1 the wickets are properly pitched. See clause 8 (The wickets).
- 2.4.2 the creases are correctly marked. See clause 7 (The creases).
- 2.4.3 the boundary of the field of play complies with the requirements of clauses 19.1 (Determining the boundary of the field of play), 19.2 (Identifying and marking the boundary) and 19.3 (Restoring the boundary).

2.5 Conduct of the match, implements and equipment

Before the toss and during the match, the umpires shall satisfy themselves that

- 2.5.1 the conduct of the match is strictly in accordance with these Playing Conditions.
- 2.5.2 the implements used in the match conform to the following
 - 2.5.2.1 clause 4 (The ball).
 - 2.5.2.2 externally visible requirements of clause 5 (The bat) and paragraph 1 of Appendix B.
 - 2.5.2.3 either clauses 8.2 (Size of stumps) and 8.3 (The bails).
- 2.5.3 no player uses equipment other than that permitted. See paragraph 2 of Appendix A. Note particularly therein the interpretation of 'protective helmet'.
- 2.5.4 the wicket-keeper's gloves comply with the requirements of clause 27.2 (Gloves).

2.6 Fair and unfair play

The umpires shall be the sole judges of fair and unfair play.

2.7 Fitness for play

- 2.7.1 It is solely for the umpires together to decide whether either conditions of ground, weather or light or exceptional circumstances mean that it would be dangerous or unreasonable for play to take place.

Conditions shall not be regarded as either dangerous or unreasonable merely because they are not ideal.

The fact that the grass and the ball are wet does not warrant the ground conditions being regarded as unreasonable or dangerous.
- 2.7.2 Conditions shall be regarded as dangerous if there is actual and foreseeable risk to the safety of any player or umpire.
- 2.7.3 Conditions shall be regarded as unreasonable if, although posing no risk to safety, it would not be sensible for play to proceed.

2.7.4 If the umpires consider the ground is so wet or slippery as to deprive the bowler of a reasonable foothold, the fielders of the power of free movement, or the batsmen of the ability to play their strokes or to run between the wickets, then these conditions shall be regarded as so bad that it would be dangerous and unreasonable for play to take place.

2.8 Suspension of play in dangerous or unreasonable circumstances

- 2.8.1 All references to ground include the pitch. See clause 6.1 (Area of pitch).
- 2.8.2 If at any time the umpires together agree that the conditions of ground, weather or light, or any other circumstances are dangerous or unreasonable, they shall immediately suspend play, or not allow play to start or to recommence. The decision as to whether conditions are so bad as to warrant such action is one for the umpires alone to make, following consultation with the ICC Match Referee.
- 2.8.3 If circumstances are warranted, the umpires shall stop play and instruct the Ground Authority to take whatever action they can and use whatever equipment is necessary to remove as much dew as possible from the outfield when conditions become unreasonable or dangerous. The umpires may also instruct the ground staff to take such action during scheduled and unscheduled breaks in play.
- 2.8.4 The umpires shall disregard any shadow on the pitch from the stadium or from any permanent object on the ground.
- 2.8.5 Light Meters
- It is the responsibility of the ICC to supply light meters to the match officials to be used in accordance with these playing conditions.
- 2.8.5.1 All light meters shall be uniformly calibrated.
- 2.8.5.2 The umpires shall be entitled to use light meter readings as a guideline for determining whether the light is fit for play in accordance with the criteria set out in clause 2.8.2 above.
- 2.8.5.3 Light meter readings may accordingly be used by the umpires:
- 2.8.5.3.1 To determine whether there has been at any stage a deterioration or improvement in the light.
- 2.8.5.3.2 As benchmarks for the remainder of a match.
- 2.8.6 Use of artificial lights
- If in the opinion of the umpires, natural light is deteriorating to an unfit level, they shall authorize the Ground Authority to use the available artificial lighting so that the match can commence or continue in acceptable conditions.
- In the event of power failure or lights malfunction, the provisions relating to the delay or interruption of play due to bad weather or light shall apply.

- 2.8.7 When there is a suspension of play it is the responsibility of the umpires to monitor conditions. They shall make inspections as often as appropriate, unaccompanied by any players or officials. Immediately the umpires together agree that the conditions are no longer dangerous or unreasonable they shall call upon the players to resume play.
- 2.8.8 The safety of all persons within the ground is of paramount importance to the ICC. In the event that of any threatening circumstance, whether actual or perceived (including for example weather, pitch invasions, act of God, etc.), then the umpires, on the advice of the ICC Match Referee, should suspend play and all players and officials should immediately be asked to leave the field of play in a safe and orderly manner and to relocate to a secure and safe area (depending on each particular threat) pending the satisfactory passing or resolution of such threat or risk to the reasonable satisfaction of the umpires, ICC Match Referee, the head of the relevant Ground Authority, the head of ground security and/or the police as the circumstances may require.
- 2.8.9 Where play is suspended under clause 2.8.8 above the decision to abandon or resume play shall be the responsibility of the ICC Match Referee who shall act only after consultation with the head of ground security and the police.

2.9 Position of umpires

The umpires shall stand where they can best see any act upon which their decision may be required.

Subject to this over-riding consideration, the bowler's end umpire shall stand in a position so as not to interfere with either the bowler's run-up or the striker's view.

The striker's end umpire may elect to stand on the off side instead of the on side of the pitch, provided he/she informs the captain of the fielding side, the striker and the other umpire.

2.10 Umpires changing ends

Shall not apply.

2.11 Disagreement and dispute

Where there is disagreement or dispute about any matter, the umpires together shall make the final decision. See also clause 31.6 (Consultation by umpires).

2.12 Umpire's decision

An umpire may alter any decision provided that such alteration is made promptly. This apart, an umpire's decision, once made, is final.

2.13 Signals

- 2.13.1 The following code of signals shall be used by umpires.
- 2.13.1.1 Signals made while the ball is in play
- No ball - by extending one arm horizontally.
- Out - by raising an index finger above the head. (If not out, the umpire shall call Not out.)
- Wide - by extending both arms horizontally.
- Dead ball - by crossing and re-crossing the wrists below the waist.
- 2.13.1.2 When the ball is dead, the bowler's end umpire shall repeat the signals in clause 2.13.1.1, with the exception of the signal for Out, to the scorers.
- 2.13.1.3 The signals listed below shall be made to the scorers only when the ball is dead.
- Boundary 4 - by waving an arm from side to side finishing with the arm across the chest.
- Boundary 6 - by raising both arms above the head.
- Bye - by raising an open hand above the head.
- Five Penalty runs awarded to the batting side – by repeated tapping of one shoulder with the opposite hand.
- Five Penalty runs awarded to the fielding side – by placing one hand on the opposite shoulder.
- Leg bye - by touching a raised knee with the hand.
- Revoke last signal - by touching both shoulders, each with the opposite hand.
- Short run - by bending one arm upwards and touching the nearer shoulder with the tips of the fingers.
- Free Hit – after signaling the No ball, the bowler's end umpire extends one arm straight upwards and moves it in a circular motion.
- Powerplay Over – by rotating his arm in a large circle.
- The following signal is for Level 4 player conduct offences. The signal has two parts, both of which should be acknowledged separately by the scorers.
- Level 4 conduct
- Part 1 – by putting one arm out to the side of the body and repeatedly raising it and lowering it.
- Part 2 – by raising an index finger, held at shoulder height, to the side of the body.

2.13.1.4 All the signals in clause 2.13.1.3 are to be made by the bowler's end umpire except that for Short run, which is to be signalled by the umpire at the end where short running occurs. However, the bowler's end umpire shall be responsible both for the final signal of Short run to the scorers and, if more than one run is short, for informing them as to the number of runs to be recorded.

2.13.2 The umpire shall wait until each signal to the scorers has been separately acknowledged by a scorer before allowing play to proceed.

If several signals are to be used, they should be given in the order that the events occurred.

2.14 Informing the umpires

Wherever the umpires are to receive information from captains or other players under these Playing Conditions, it will be sufficient for one umpire to be so informed and for him/her to inform the other umpire.

2.15 Correctness of scores

Consultation between umpires and scorers on doubtful points is essential. The umpires shall, throughout the match, satisfy themselves as to the correctness of the number of runs scored, the wickets that have fallen and, where appropriate, the number of overs bowled.

The umpires shall ensure that they are able to contact the scorers at any time during the match and at its conclusion to address any issues relating to the correctness of scores.

3 THE SCORERS**3.1 Appointment of scorers**

Two scorers shall be appointed to record all runs scored, all wickets taken and, where appropriate, number of overs bowled.

3.2 Correctness of scores

The scorers shall frequently check to ensure that their records agree and consult with the umpires if necessary. See clause 2.15 (Correctness of scores).

3.3 Acknowledging signals

The scorers shall accept all instructions and signals given to them by the umpires and shall immediately acknowledge each separate signal.

4 THE BALL**4.1 Weight and size**

The ball, when new, shall weigh not less than 5.5 ounces/155.9 g, nor more than 5.75 ounces/163 g, and shall measure not less than 8.81 in/22.4 cm, nor more than 9 in/22.9 cm in circumference.

4.2 Approval and control of balls

- 4.2.1 The Home Board shall provide white cricket balls of an approved standard for T20I cricket and spare used balls for changing during a match, which shall also be of the same brand. Note: The Home Board shall be required to advise the Visiting Board of the brand of ball to be used in the match(es) at least 30 days prior to the start of the match(es).
- 4.2.2 The fielding captain or his nominee may select the ball with which he wishes to bowl from the supply provided by the Home Board. The fourth umpire shall take a box containing at least 6 new balls to the dressing room and supervise the selection of the ball.
- 4.2.3 The umpires shall retain possession of the match ball(s) throughout the duration of the match when play is not actually taking place.
- 4.2.4 During play umpires shall periodically and irregularly inspect the condition of the ball and shall retain possession of it at the fall of a wicket or any other disruption in play.

4.3 New ball

- 4.3.1 One new ball shall be used at the start of each innings.

4.4 Ball lost or becoming unfit for play

If, during play, the ball cannot be found or recovered or the umpires agree that it has become unfit for play through normal use, the umpires shall replace it with a ball which has had wear comparable with that which the previous ball had received before the need for its replacement. When the ball is replaced, the umpire shall inform the batsmen and the fielding captain.

5 THE BAT**5.1 The bat**

- 5.1.1 The bat consists of two parts, a handle and a blade.
- 5.1.2 The basic requirements and measurements of the bat are set out in this clause with detailed specifications in paragraph 1 of Appendix B.

5.2 The handle

- 5.2.1 The handle is to be made principally of cane and/or wood.
- 5.2.2 The part of the handle that is wholly outside the blade is defined to be the upper portion of the handle. It is a straight shaft for holding the bat.
- 5.2.3 The upper portion of the handle may be covered with a grip as defined in paragraph 1.2.2 of Appendix B.

5.3 The blade

- 5.3.1 The blade comprises the whole of the bat apart from the handle as defined in clause 5.2 and in paragraph 1.3 of Appendix B.
- 5.3.2 The blade shall consist solely of wood.

5.4 Protection and repair

Subject to the specifications in paragraph 1.4 of Appendix B. and providing clause 5.5 is not contravened,

- 5.4.1 solely for the purposes of
either
protection from surface damage to the face, sides and shoulders of the blade
or
repair to the blade after surface damage,
material that is not rigid, either at the time of its application to the blade or subsequently, may be placed on these surfaces.
- 5.4.2 for repair of the blade after damage other than surface damage
- 5.4.2.1 solid material may be inserted into the blade.
- 5.4.2.2 The only material permitted for any insertion is wood with minimal essential adhesives.
- 5.4.3 to prevent damage to the toe, material may be placed on that part of the blade but shall not extend over any part of the face, back or sides of the blade.

5.5 Damage to the ball

- 5.5.1 For any part of the bat, covered or uncovered, the hardness of the constituent materials and the surface texture thereof shall not be such that either or both could cause unacceptable damage to the ball.
- 5.5.2 Any material placed on any part of the bat, for whatever purpose, shall similarly not be such that it could cause unacceptable damage to the ball.
- 5.5.3 For the purpose of this clause, unacceptable damage is any change that is greater than normal wear and tear caused by the ball striking the uncovered wooden surface of the blade.

5.6 Contact with the ball

In these clauses,

- 5.6.1 reference to the bat shall imply that the bat is held in the batsman's hand or a glove worn on his hand, unless stated otherwise.
- 5.6.2 contact between the ball and any of 5.6.2.1 to 5.6.2.4
- 5.6.2.1 the bat itself
- 5.6.2.2 the batsman's hand holding the bat

5.6.2.3 any part of a glove worn on the batsman's hand holding the bat

5.6.2.4 any additional materials permitted under 5.4

shall be regarded as the ball striking or touching the bat or being struck by the bat.

5.7 Bat size limits

5.7.1 The overall length of the bat, when the lower portion of the handle is inserted, shall not be more than 38 in/96.52 cm.

5.7.2 The blade of the bat shall not exceed the following dimensions:

Width: 4.25in/10.8 cm

Depth: 2.64in/6.7 cm

Edges: 1.56in/4.0cm.

Furthermore, it should also be able to pass through a bat gauge as described in paragraph 1.6 of Appendix B.

5.7.3 The handle shall not exceed 52% of the overall length of the bat.

5.7.4 The material permitted for covering the blade in clause 5.4.1 shall not exceed 0.04 in/0.1 cm in thickness.

5.7.5 The maximum permitted thickness of protective material placed on the toe of the blade is 0.12 in/0.3 cm.

5.8 Categories of bat

5.8.1 Type A bats conform to clauses 5.1 to 5.7 inclusive.

5.8.2 Only Type A bats may be used in T20I matches.

6 THE PITCH

6.1 Area of pitch

The pitch is a rectangular area of the ground 22 yards/20.12 m in length and 10 ft/3.05 m in width. It is bounded at either end by the bowling creases and on either side by imaginary lines, one each side of the imaginary line joining the centres of the two middle stumps, each parallel to it and 5 ft/1.52 m from it. If the pitch is next to an artificial pitch which is closer than 5 ft/1.52 m from the middle stumps, the pitch on that side will extend only to the junction of the two surfaces. See clauses 8.1 (Description, width and pitching) and 7.2 (The bowling crease).

6.2 Fitness of pitch for play

The umpires shall be the sole judges of the fitness of the pitch for play. See clauses 2.7 (Fitness for play) and 2.8 (Suspension of play in dangerous or unreasonable conditions).

6.3 Selection and preparation

Before the match, the Ground Authority shall be responsible for the selection and preparation of the pitch. During the match, the umpires shall control its use and maintenance.

6.3.1 The Ground Authority shall ensure that during the period prior to the start of play and during intervals, the pitch area shall be roped off so as to prevent unauthorised access. (The pitch area shall include an area at least 2 metres beyond the rectangle made by the crease markings at both ends of the pitch).

6.3.2 The fourth umpire shall ensure that, prior to the start of play and during any intervals, only authorised staff, the ICC match officials, players, team coaches and authorised television personnel shall be allowed access to the pitch area. Such access shall be subject to the following limitations:

6.3.2.1 Only captains and team coaches may walk on the actual playing surface of the pitch area (outside of the crease markings).

6.3.2.2 Access to the pitch area by television personnel shall be restricted to one camera crew (including one or two television commentators) of the official licensed television broadcaster(s) (but not news crews).

6.3.2.3 No spiked footwear shall be permitted.

6.3.2.4 No one shall be permitted to bounce a ball on the pitch, strike it with a bat or cause damage to the pitch in any other way.

6.3.2.5 Access shall not interfere with pitch preparation.

6.3.3 In the event of any dispute, the ICC Match Referee will rule and his ruling will be final.

6.4 Changing the pitch

6.4.1 If the on-field umpires decide that it is dangerous or unreasonable for play to continue on the match pitch, they shall stop play and immediately advise the ICC Match Referee.

6.4.2 The on-field umpires and the ICC Match Referee shall then consult with both captains.

6.4.3 If the captains agree to continue, play shall resume.

6.4.4 If the decision is not to resume play, the on-field umpires together with the ICC Match Referee shall consider whether the existing pitch can be repaired and the match resumed from the point it was stopped. In considering whether to authorise such repairs, the ICC Match Referee must consider whether this would place either side at an unfair advantage, given the play that had already taken place on the dangerous pitch.

- 6.4.5 If the decision is that the existing pitch cannot be repaired, then the match is to be abandoned with the following consequences:
- 6.4.5.1 In the event of the required number of overs to constitute a match having been completed at the time the match is abandoned, the result shall be determined according to the provisions of clause 16.4.2.
 - 6.4.5.2 In the event of the required number of overs to constitute a match not having been completed, the match will be abandoned as a no result.
- 6.4.6 If the abandonment occurs on the day of the match, the ICC Match Referee shall consult with the Home Board with the objective of finding a way for a new match (including a new nomination of teams and toss) to commence on the same date and venue. Such a match may be played either on the repaired pitch or on another pitch, subject to the ICC Match Referee and the relevant Ground Authority both being satisfied that the new pitch will be of the required T20I standard. The playing time lost between the scheduled start time of the original match and the actual start time of the new match will be covered by the provisions of clause 12.
- 6.4.7 If it is not possible to start a new match on the scheduled day of the match, the relevant officials from the participating Boards shall agree on whether the match can be replayed within the existing tour schedule.
- 6.4.8 Throughout the above decision making processes, the ICC Match Referee shall keep informed both captains and the head of the Ground Authority. The head of the Ground Authority shall ensure that suitable and prompt public announcements are made.

6.5 Non-turf pitches

All T20I matches shall be played on natural turf pitches. The use of PVA and other adhesives in the preparation of pitches is not permitted.

7 THE CREASES

7.1 The creases

The positions of a bowling crease, a popping crease and two return creases shall be marked by white lines, as set out in clauses 7.2, 7.3 and 7.4, at each end of the pitch. See paragraph 1 of Appendix C.

7.2 The bowling crease

The bowling crease, which is the back edge of the crease marking, is the line that marks the end of the pitch, as in clause 6.1 (Area of pitch). It shall be 8 ft 8 in/2.64 m in length.

7.3 The popping crease

The popping crease, which is the back edge of the crease marking, shall be in front of and parallel to the bowling crease and shall be 4 ft/1.22 m from it. The popping crease shall be marked to a minimum of 15 yards/13.71 m on either side of the imaginary line joining the centres of the two middle stumps and shall be considered to be unlimited in length.

7.4 The return creases

The return creases, which are the inside edges of the crease markings, shall be at right angles to the popping crease at a distance of 4 ft 4 in/1.32 m either side of the imaginary line joining the centres of the two middle stumps. Each return crease shall be marked from the popping crease to a minimum of 8 ft/2.44 m behind it and shall be considered to be unlimited in length.

7.5 Additional Crease Markings

As a guideline to the umpires for the calling of Wides on the offside, the crease markings detailed in paragraph 1 of Appendix C may be marked in white at each end of the pitch.

8 THE WICKETS

8.1 Description, width and pitching

Two sets of wickets shall be pitched opposite and parallel to each other in the centres of the bowling creases. Each set shall be 9 in/22.86 cm wide and shall consist of three wooden stumps with two wooden bails on top. See paragraph 2 of Appendix B.

8.2 Size of stumps

The tops of the stumps shall be 28 in/71.12 cm above the playing surface and shall be dome shaped except for the bail grooves. The portion of a stump above the playing surface shall be cylindrical apart from the domed top, with circular section of diameter not less than 1.38 in/3.50 cm nor more than 1.5 in/3.81 cm. See paragraph 2 of Appendix B.

For televised matches the Home Board may provide a slightly larger cylindrical stump to accommodate the stump camera. When the larger stump is used, all three stumps must be exactly the same size.

8.3 The bails

- 8.3.1 The bails, when in position on top of the stumps,
- shall not project more than 0.5 in/1.27 cm above them.
 - shall fit between the stumps without forcing them out of the vertical.
- 8.3.2 Each bail shall conform to the following specifications (see paragraph 2 of Appendix B).
- Overall length 4.31 in/10.95 cm
 - Length of barrel 2.13 in /5.40 cm
 - Longer spigot 1.38 in/3.50 cm
 - Shorter spigot 0.81 in/2.06 cm.
- 8.3.3 The two spigots and the barrel shall have the same centre line.
- 8.3.4 Devices aimed at protecting player safety by limiting the distance that a bail can travel off the stumps will be allowed, subject to the approval of the Home Board and the ICC.

8.4 Dispensing with bails

The umpires may agree to dispense with the use of bails, if necessary. If they so agree then no bails shall be used at either end. The use of bails shall be resumed as soon as conditions permit. See clause 29.4 (Dispensing with bails).

8.5 LED Wickets

The use of approved LED Wickets is permitted. Refer also to paragraphs 3.8.1.6 and 4.2 of Appendix D.

9 PREPARATION AND MAINTENANCE OF THE PLAYING AREA**9.1 Rolling**

The pitch shall not be rolled during the match except as permitted in clauses 9.1.1 and 9.1.2.

9.1.1 Frequency and duration of rolling

During the match the pitch may be rolled at the request of the captain of the side batting second, for a period of not more than 7 minutes, before the start of the second innings.

9.1.2 Rolling after a delayed start

In addition to the rolling permitted above, if, after the toss and before the first innings of the match, the start is delayed, the captain of the batting side may request that the pitch be rolled for not more than 7 minutes. However, if the umpires together agree that the delay has had no significant effect on the state of the pitch, they shall refuse such request for rolling of the pitch.

9.1.3 Choice of rollers

If there is more than one roller available the captain of the batting side shall choose which one is to be used.

The following shall apply in addition to clause 9.1:

9.1.4 Prior to the scheduled time for the toss, the artificial drying of the pitch and outfield shall be at the discretion of the Ground Authority. Thereafter and throughout the match the drying of the outfield may be undertaken at any time by the Ground Authority, but the drying of the affected area of the pitch shall be carried out only on the instructions and under the supervision of the umpires. The umpires shall be empowered to have the pitch dried without reference to the captains at any time they are of the opinion that it is unfit for play.**9.1.5 The umpires may instruct the Ground Authority to use any available equipment, including any roller for the purpose of drying the pitch and making it fit for play.****9.1.6 An absorbent roller may be used to remove water from the covers including the cover on the match pitch.****9.2 Clearing debris from the pitch****9.2.1 The pitch shall be cleared of any debris****9.2.1.1 between innings. This shall precede rolling if any is to take place.****9.2.2 The clearance of debris in clause 9.2.1 shall be done by sweeping, except where the umpires consider that this may be detrimental to the surface of the pitch. In this case the debris must be cleared from that area by hand, without sweeping.****9.2.3 In addition to clause 9.2.1, debris may be cleared from the pitch by hand, without sweeping, before mowing and whenever either umpire considers it necessary.****9.3 Mowing****9.3.1 Responsibility for mowing****9.3.1.1 All mowings which are carried out before the match shall be the sole responsibility of the Ground Authority.****9.4 Watering the pitch**

The pitch shall not be watered during the match.

9.5 Re-marking creases

Creases shall be re-marked whenever either umpire considers it necessary.

9.6 Maintenance of footholes

The umpires shall ensure that the holes made by the bowlers and batsmen are cleaned out and dried whenever necessary to facilitate play.

The umpires shall allow, if necessary, the returfing of footholes made by the bowlers in their delivery strides, or the use of quick-setting fillings for the same purpose.

In addition, the umpires shall see that wherever possible and whenever it is considered necessary, action is taken during all intervals in play to do whatever is practicable to improve the bowler's footholes.

9.7 Securing of footholds and maintenance of pitch

During play, umpires shall allow the players to secure their footholds by the use of sawdust provided that no damage to the pitch is caused and that clause 41 (Unfair play) is not contravened.

9.8 Protection and preparation of adjacent pitches during matches

The protection (by way of an appropriate cover) and preparation of pitches which are adjacent to the match pitch will be permitted during the match subject to the following:

9.8.1 Such measures will only be possible if requested by the Ground Authority and approved by the umpires before the start of the match.**9.8.2 Approval should only be granted where such measures are unavoidable and will not compromise the safety of the players or their ability to execute their actions with complete freedom.**

- 9.8.3 The preparation work shall be carried out under the supervision of the fourth umpire.
- 9.8.4 The consent of the captains is not required but the umpires shall advise both captains and the ICC Match Referee before the start of the match on what has been agreed.

10 COVERING THE PITCH

10.1 Before the match

The use of covers before the match is the responsibility of the Ground Authority and may include full covering if required.

The pitch shall be entirely protected against rain up to the commencement of play.

However, the Ground Authority shall grant suitable facility to the captains to inspect the pitch before the nomination of their players and to the umpires to discharge their duties as laid down in clauses 2 (The umpires), 6 (The pitch), 7 (The creases), 8 (The wickets), and 9 (Preparation and maintenance of the playing area).

10.2 During the match

The pitch shall be entirely protected against rain up to the commencement of play, and for the duration of the period of the match.

The covers must totally protect the pitch and also the pitch surroundings, to a minimum of 5 metres either side of the pitch, and any worn or soft areas in the outfield.

The bowlers' run-ups shall be covered during inclement weather, in order to keep them dry, to a distance of at least 10 x 10 metres.

10.3 Removal of covers

All covers (including "hessian" or "scrim" covers used to protect the pitch against the sun) shall be removed not later than 2 ½ hours before the scheduled start of play provided it is not raining at the time, but the pitch will be covered again if rain falls prior to the commencement of play.

11 INTERVALS

11.1 An interval

- 11.1.1 The following shall be classed as intervals.
- Intervals between innings.
 - Any other agreed interval.

11.1.2 Only these intervals shall be considered as scheduled breaks for the purposes of clause 24.2.6.

11.2 Duration of interval

11.2.1 There shall be a 20 minute interval between innings, taken from the call of Time before the interval until the call of Play on resumption after the interval.

11.3 Allowance for interval between innings

Law 11.3 of the Laws of Cricket shall not apply.

11.4 Changing agreed times of intervals

11.4.1 If the innings of the team batting first is completed prior to the scheduled time for the interval, the interval shall take place immediately and the innings of the team batting second will commence correspondingly earlier. In circumstances where the side bowling first has not completed the allotted number of overs by the scheduled or re-scheduled cessation time for the first innings, the umpires shall reduce the length of the interval by the amount of time that the first innings over-ran. The minimum time for the interval will be 10 minutes.

11.4.2 However, following a lengthy delay or interruption prior to the completion of the innings of the team batting first, the Match Referee may, at his discretion, reduce the interval between innings from 20 minutes to not less than 10 minutes.

11.4.3 Such discretion should only be exercised after determining the adjusted overs per side based on a 20 minute interval. If having exercised this discretion, the rescheduled finishing time for the match is earlier than the latest possible finishing time, then these minutes should be deducted from the length of any interruption during the second innings before determining the overs remaining.

11.5 Intervals for drinks

11.5.1 No drinks intervals shall be permitted.

11.5.2 An individual player may be given a drink either on the boundary edge or at the fall of a wicket, on the field, provided that no playing time is wasted. No other drinks shall be taken onto the field without the permission of the umpires. Any player taking drinks onto the field shall be dressed in proper cricket attire (subject to the wearing of bibs – refer to the note in clause 24.1.4).

11.6 Scorers to be informed

The umpires shall ensure that the scorers are informed of all agreements about hours of play and intervals and of any changes made thereto as permitted under this clause.

12 START OF PLAY; CESSATION OF PLAY

12.1 Call of Play

The bowler's end umpire shall call Play before the first ball of the match and on the resumption of play after any interval or interruption.

12.2 Call of Time

The bowler's end umpire shall call Time, when the ball is dead, at the end of any session of play or as required by these Playing Conditions. See also clause 20.3 (Call of Over or Time).

12.3 Removal of bails

After the call of Time, the bails shall be removed from both wickets.

12.4 Starting a new over

Another over shall always be started at any time during the match, unless an interval is to be taken in the circumstances set out in clause 12.5.2, if the umpire, walking at normal pace, has arrived at the position behind the stumps at the bowler's end before the time agreed for the next interval has been reached.

12.5 Completion of an over

Other than at the end of the match,

12.5.1 if the agreed time for an interval is reached during an over, the over shall be completed before the interval is taken, except as provided for in clause 12.5.2.

12.5.2 when less than 3 minutes remains before the time agreed for the next interval, the interval shall be taken immediately if either a batsman is dismissed or retires, or the players have occasion to leave the field, whether this occurs during an over or at the end of an over. Except at the end of an innings, if an over is thus interrupted it shall be completed on the resumption of play.

12.6 Conclusion of match

12.6.1 The match is concluded

12.6.1.1 as soon as a result as defined in clauses 16.1 to 16.5 (The result) is reached.

12.6.1.2 as soon as the prescribed number of overs have been completed.

12.6.2 The match is concluded if, without a conclusion having been reached under 12.6.1, the players leave the field for adverse conditions of ground, weather or light, or in exceptional circumstances, and no further play is possible.

12.7 Hours of Play; Minimum Overs Requirement

12.7.1 To be determined by the Home Board subject to there being 2 sessions of 1 hour 25 minutes each, separated by a 20 minute interval between innings.

12.8 Minimum Over Rates

12.8.1 The minimum over rate to be achieved in T20I Matches shall be 14.11 overs per hour.

12.8.2 The actual over rate shall be calculated at the end of each innings by the umpires.

12.8.3 In calculating the actual over rate for the match, allowances shall be given as follows:

12.8.3.1 The time lost as a result of treatment given to a player by an authorised medical personnel on the field of play;

12.8.3.2 The time lost as a result of a player being required to leave the field as a result of a serious injury;

12.8.3.3 The time taken for all third umpire referrals and consultations and any umpire or player reviews;

12.8.3.4 The time lost as a result of time wasting by the batting side; and

12.8.3.5 The time lost due to all other circumstances that are beyond the control of the fielding side.

12.8.4 In the event of any time allowances being granted to the fielding team under clause 12.8.3.4 above (time wasting by batting team), then such time shall be deducted from the allowances granted to such batting team in the determination of its over rate.

12.8.5 In addition to the allowances as provided for above,

12.8.5.1 in the case of an innings that has been reduced due to any delay or interruption in play, an additional allowance of 1 minute for every full 3 overs by which the innings is reduced will be granted.

12.8.5.2 an additional allowance of 1 minute will be given for each of the 6th, 7th, 8th and 9th wickets taken during an innings.

12.8.6 If a batting team is bowled out within the time determined for that innings pursuant to these playing conditions (taking into account all of the time allowances set out above), the fielding side shall be deemed to have complied with the required minimum over rate.

12.8.7 The current over rate of the fielding team (+/- overs compared to the minimum rate required), to be advised by the 3rd umpire every 30 minutes as a minimum, shall be displayed on a scoreboard or replay screen.

13 INNINGS**13.1 Number of innings**

13.1.1 A match shall be one innings for each side.

13.2 Alternate innings

Each side shall take their innings alternately.

13.3 Completed innings

A side's innings is to be considered as completed if any of the following applies

13.3.1 the side is all out.

13.3.2 at the fall of a wicket or the retirement of a batsman, further balls remain to be bowled but no further batsman is available to come in.

13.3.3 the prescribed number of overs have been bowled to the batting side.

13.4 The toss

The captains shall toss a coin for the choice of innings, on the field of play and under the supervision of the ICC Match Referee, not earlier than 30 minutes, nor later than 15 minutes before the scheduled or any rescheduled time for the start of play. Note, however, the provisions of clause 1.3 (Captain).

13.5 Decision to be notified

As soon as the toss is completed, the captain of the side winning the toss shall decide whether to bat or to field and shall notify the opposing captain and the umpires of this decision. Once notified, the decision cannot be changed.

13.6 Duration of Match

13.6.1 All matches will consist of one innings per side, each innings being limited to a maximum of 20 overs. All matches shall be of one day's scheduled duration.

13.7 Length of Innings

13.7.1 Uninterrupted Matches.

13.7.1.1 Each team shall bat for 20 overs unless all out earlier.

13.7.1.2 If the team fielding first fails to bowl the required number of overs by the scheduled time for cessation of the first innings, play shall continue until the required number of overs has been bowled. The interval shall not be extended and the second session shall commence at the scheduled time. The team batting second shall receive its full quota of 20 overs irrespective of the number of overs it bowled in the scheduled time for the cessation of the first innings.

13.7.1.3 If the team batting first is dismissed in less than 20 overs, the team batting second shall be entitled to bat for 20 overs.

13.7.1.4 If the team fielding second fails to bowl 20 overs by the scheduled cessation time, the hours of play shall be extended until the required number of overs has been bowled or a result is achieved.

13.7.1.5 Penalties shall apply for slow over rates (refer to the ICC Code of Conduct).

13.7.2 Delayed or Interrupted Matches

13.7.2.1 Delay or Interruption to the Innings of the Team Batting First (see paragraph 1 of Appendix E)

13.7.2.1.1 When playing time has been lost the revised number of overs to be bowled in the match shall be based on a rate of 14.11 overs per hour in the total remaining time available for play.

13.7.2.1.2 The revision of the number of overs should ensure, whenever possible, that both teams have the opportunity of batting for the same number of overs. The team batting second shall not bat for a greater number of overs than the first team unless the latter completed its innings in less than its allocated overs. To constitute a match, a minimum of 5 overs have to be bowled to the side batting second, subject to a result not being achieved earlier.

13.7.2.1.3 As soon as the total minutes of playing time remaining is less than the completed overs faced by Team 1 multiplied by 4.25, then the first innings is terminated and the provisions of 13.7.2.2 below take effect.

13.7.2.1.4 A fixed time will be specified for the commencement of the interval, and also the close of play for the match, by applying a rate of 14.11 overs per hour. When calculating the length of playing time available for the match, or the length of either innings, the timing and duration of all relative delays, extensions in playing hours, interruptions in play, and intervals will be taken into consideration. This calculation must not cause the match to finish earlier than the original or rescheduled time for cessation of play on the final scheduled day for play. If required the original time shall be extended to allow for one extra over for each team.

13.7.2.1.5 If the team fielding first fails to bowl the revised number of overs by the specified time, play shall continue until the required number of overs have been bowled or the innings is completed.

13.7.2.1.6 Penalties shall apply for slow over rates (refer to the ICC Code of Conduct).

13.7.2.2 Delay or Interruption to the Innings of the Team Batting Second (see paragraph 2 of Appendix E)

13.7.2.2.1 When playing time has been lost and, as a result, it is not possible for the team batting second to have the opportunity of receiving its allocated, or revised allocation of overs in the playing time available, the number of overs shall be reduced at a rate of 14.11 overs per hour in respect of the lost playing time. Should the calculations result in a fraction of an over the fraction shall be ignored.

- 13.7.2.2.2 In addition, should the innings of the team batting first have been completed prior to the scheduled, or re-scheduled time for the commencement of the interval, then any calculation relating to the revision of overs shall not be effective until an amount of time equivalent to that by which the second innings started early has elapsed.
- 13.7.2.2.3 To constitute a match, a minimum of 5 overs have to be bowled to the team batting second subject to a result not being achieved earlier.
- 13.7.2.2.4 The team batting second shall not bat for a greater number of overs than the first team unless the latter completed its innings in less than its allocated overs.
- 13.7.2.2.5 A fixed time will be specified for the close of play by applying a rate of 14.11 overs per hour. The timing and duration of all relative delays, extensions in playing hours and interruptions in play will be taken into consideration in specifying this time.
- 13.7.2.2.6 If the team fielding second fails to bowl the revised overs by the scheduled or re-scheduled close of play, the hours of play shall be extended until the overs have been bowled or a result achieved.
- 13.7.2.2.7 Penalties shall apply for slow over rates (refer to the ICC Code of Conduct).

13.8 Extra Time

The participating countries may agree to provide for extra time where the start of play is delayed or play is suspended. For clarity, the changeover period (maximum 10 mins) for a Super Over after the main match is not to be taken into account when applying any permitted extra time available.

13.9 Number of Overs per Bowler

- 13.9.1 No bowler shall bowl more than 4 overs in an innings.
- 13.9.2 In a delayed or interrupted match where the overs are reduced for both teams or for the team bowling second;
- 13.9.2.1 for innings of rescheduled length of at least 10 overs, no bowler may bowl more than one-fifth of the total overs allowed. Where the total overs is not divisible by 5, one additional over shall be allowed to the maximum number per bowler necessary to make up the balance.
- 13.9.2.2 for innings of rescheduled length of between 5 and 9 overs, no bowler may bowl more than two overs.

- 13.9.3 In the event of a bowler breaking down and being unable to complete an over, the remaining balls will be allowed by another bowler. Such part of an over will count as a full over only in so far as each bowler's limit is concerned.
- 13.9.4 The scoreboard shall show the total number of overs bowled and the number of overs bowled by each bowler.

14 THE FOLLOW-ON

Shall not apply.

15 DECLARATION AND FORFEITURE

Shall not apply.

16 THE RESULT

16.1 A Win

- 16.1.1 The side which has scored in its one innings a total of runs in excess of that scored by the opposing side in its one completed innings shall win the match. See clause 13.3 (Completed innings). Note also clause 16.4 (Winning hit or extras).
- 16.1.2 Save for circumstances where a match is awarded to a team as a consequence of the opposing team's refusal to play (Clause 16.2), a result can be achieved only if both teams have had the opportunity of batting for at least 5 overs, unless one team has been all out in less than 5 overs or unless the team batting second scores enough runs to win in less than 5 overs.
- 16.1.3 Save for circumstances where a match is awarded to a team as a consequence of the opposing team's refusal to play (Clause 16.2), all matches in which both teams have not had an opportunity of batting for a minimum of 5 overs, shall be declared a No Result.

16.2 ICC Match Referee awarding a match

- 16.2.1 A match shall be lost by a side which either
- 16.2.1.1 concedes defeat or
- 16.2.1.2 in the opinion of the ICC Match Referee refuses to play and the ICC Match Referee shall award the match to the other side.
- 16.2.2 If an umpire considers that an action by any player or players might constitute a refusal by either side to play then the umpires together shall inform the ICC Match Referee of this fact. The ICC Match Referee shall together with the umpires ascertain the cause of the action. If the ICC Match Referee, after due consultation with the umpires, then decides that this action does constitute a refusal to play by one side, he/she shall so inform the captain of that side. If the captain persists in the action the ICC Match Referee shall award the match in accordance with clause 16.2.1.2 above.

- 16.2.3 If action as in clause 16.2.2 above takes place after play has started and does not constitute a refusal to play the delay or interruption in play shall be dealt with in the same manner as provided for in clauses 13.7.2 (Delayed and Interrupted Matches) and 11.4 (Changing agreed times for intervals) above.

Note: In addition to the consequences of any refusal to play prescribed under this clause, any such refusal, whether temporary or final, may result in disciplinary action being taken against the captain and team responsible under the ICC Code of Conduct.

16.3 All other matches – A Tie or No Result

16.3.1 A Tie

The result of a match shall be a Tie when all innings have been completed and the scores are equal.

If the scores are equal, the result shall be a tie and no account shall be taken of the number of wickets that have fallen. In the event of a tied match the teams shall compete in a Super Over to determine the winner. Refer to Appendix F.

16.3.2 No Result

See 16.1.3 above.

16.4 Prematurely Terminated Matches - Calculation of the Target Score

16.4.1 Interrupted Matches – Calculation of the Target Score

- 16.4.1.1 If, due to suspension of play after the start of the match, the number of overs in the innings of either team has to be revised to a lesser number than originally allotted (minimum of 5 overs), then a revised target score (to win) should be set for the number of overs which the team batting second will have the opportunity of facing. This revised target is to be calculated using the current Duckworth/Lewis/Stern method. The target set will always be a whole number and one run less will constitute a Tie. (Refer Duckworth/Lewis/Stern Regulations)

16.4.2 Prematurely Terminated Matches

- 16.4.2.1 If the innings of the side batting second is suspended (with at least 5 overs bowled) and it is not possible for the match to be resumed, the match will be decided by comparison with the DLS 'Par Score' determined at the instant of the suspension by the Duckworth/Lewis/Stern method (refer Duckworth/Lewis/Stern Regulations). If the score is equal to the par score, the match is a Tie. Otherwise the result is a victory, or defeat, by the margin of runs by which the score exceeds, or falls short of, the Par Score.

16.5 Winning hit or extras

- 16.5.1 As soon as a result is reached as defined in clauses 16.1, 16.2 or 16.3.1, the match is at an end. Nothing that happens thereafter, except as in clause 41.18.2 (Penalty runs), shall be regarded as part of it. Note also clause 16.8.
- 16.5.2 The side batting last will have scored enough runs to win only if its total of runs is sufficient without including any runs completed by the batsmen before the completion of a catch, or the obstruction of a catch, from which the striker could be dismissed.
- 16.5.3 If a boundary is scored before the batsmen have completed sufficient runs to win the match, the whole of the boundary allowance shall be credited to the side's total and, in the case of a hit by the bat, to the striker's score.

16.6 Statement of result

If the side batting last wins the match without losing all its wickets, the result shall be stated as a win by the number of wickets still then to fall.

If, without having scored a total of runs in excess of the total scored by the opposing side, the innings of the side batting last has been completed, but as the result of an award of 5 Penalty runs its total of runs is then sufficient to win, the result shall be stated as a win to that side by Penalty runs.

If the side fielding last wins the match, the result shall be stated as a win by runs.

If the match is decided by one side conceding defeat or refusing to play, the result shall be stated as Match Conceded or Match Awarded, as the case may be.

16.7 Correctness of result

Any decision as to the correctness of the scores shall be the responsibility of the umpires. See clause 2.15 (Correctness of scores).

16.8 Mistakes in scoring

If, after the players and umpires have left the field in the belief that the match has been concluded, the umpires discover that a mistake in scoring has occurred which affects the result then, subject to clause 16.9, they shall adopt the following procedure.

- 16.8.1 If, when the players leave the field, the side batting last has not completed its innings and,
- either the number of overs to be bowled in that innings has not been completed, or
 - the end of the innings has not been reached
- then, unless one side concedes defeat, the umpires shall order play to resume.
- Unless a result is reached sooner, play will then continue, if conditions permit, until the prescribed number of overs has been completed. The number of overs shall be taken as they were at the call of Time for the supposed conclusion of the match. No account shall be taken of the time between that moment and the resumption of play.

- 16.8.2 If, at this call of Time, the overs have been completed and no Playing time remains, or if the side batting last has completed its innings, the umpires shall immediately inform both captains of the necessary corrections to the scores and to the result.

16.9 Result not to be changed

Once the umpires have agreed with the scorers the correctness of the scores at the conclusion of the match – see clauses 2.15 (Correctness of scores) and 3.2 (Correctness of scores) – the result cannot thereafter be changed.

16.10 Points

A points system shall not apply.

17 THE OVER

17.1 Number of balls

The ball shall be bowled from each end alternately in overs of 6 balls.

17.2 Start of an over

An over has started when the bowler starts his run-up or, if there is no run-up, starts his action for the first delivery of that over.

17.3 Validity of balls

- 17.3.1 A ball shall not count as one of the 6 balls of the over unless it is delivered, even though, as in clause 41.16 (Non-striker leaving his ground early) a batsman may be dismissed or some other incident occurs without the ball having been delivered.
- 17.3.2 A ball delivered by the bowler shall not count as one of the 6 balls of the over
- 17.3.2.1 if it is called dead, or is to be considered dead, before the striker has had an opportunity to play it. See clause 20.6 (Dead ball; ball counting as one of over).
 - 17.3.2.2 if it is called dead in the circumstances of clause 20.4.2.6. Note also the special provisions of clause 20.4.2.5. (Umpire calling and signaling Dead ball).
 - 17.3.2.3 if it is a No ball. See clause 21 (No ball).
 - 17.3.2.4 if it is a Wide. See clause 22 (Wide ball).
 - 17.3.2.5 when any of clauses 24.4 (Player returning without permission), 28.2 (Fielding the ball), 41.4 (Deliberate attempt to distract striker), or 41.5 (Deliberate distraction, deception or obstruction of batsman) is applied.
- 17.3.3 Any deliveries other than those listed in clause 17.3.1 and 17.3.2 shall be known as valid balls. Only valid balls shall count towards the 6 balls of the over.

17.4 Call of Over

When 6 valid balls have been bowled and when the ball becomes dead, the umpire shall call Over before leaving the wicket. See also clause 20.3 (Call of Over or Time).

17.5 Umpire miscounting

- 17.5.1 If the umpire miscounts the number of valid balls, the over as counted by the umpire shall stand.
- 17.5.2 If, having miscounted, the umpire allows an over to continue after 6 valid balls have been bowled, he/she may subsequently call Over when the ball becomes dead after any delivery, even if that delivery is not a valid ball.
- 17.5.3 Whenever possible, the third umpire shall liaise with the scorers and if possible inform the on-field umpires if the over has been miscounted.

17.6 Bowler changing ends

A bowler shall be allowed to change ends as often as desired, provided he does not bowl two overs consecutively, nor bowl parts of each of two consecutive overs, in the same innings.

17.7 Finishing an over

- 17.7.1 Other than at the end of an innings, a bowler shall finish an over in progress unless incapacitated or suspended under these Playing Conditions.
- 17.7.2 If for any reason, other than the end of an innings, an over is left uncompleted at the start of an interval or interruption, it shall be completed on resumption of play.

17.8 Bowler incapacitated or suspended during an over

If for any reason a bowler is incapacitated while running up to deliver the first ball of an over, or is incapacitated or suspended during an over, the umpire shall call and signal Dead ball. Another bowler shall complete the over from the same end, provided that he does not bowl two overs consecutively, nor bowl parts of each of two consecutive overs, in that innings.

18 SCORING RUNS

18.1 A run

The score shall be reckoned by runs. A run is scored

- 18.1.1 so often as the batsmen, at any time while the ball is in play, have crossed and made good their ground from end to end.
- 18.1.2 when a boundary is scored. See clause 19 (Boundaries).
- 18.1.3 when Penalty runs are awarded. See clause 18.6.

18.2 Runs disallowed

Wherever in these Playing Conditions provision is made for the scoring of runs or awarding of penalties, such runs and penalties will be subject to any provisions that may be applicable for the disallowance of runs or for the non-award of penalties.

When runs are disallowed, the one run penalty for No ball or Wide shall stand and 5 run penalties shall be allowed, except for Penalty runs under clause 28.3 (Protective helmets belonging to the fielding side).

18.3 Short runs

- 18.3.1 A run is short if a batsman fails to make good his ground in turning for a further run.
- 18.3.2 Although a short run shortens the succeeding one, the latter if completed shall not be regarded as short. A striker setting off for the first run from in front of the popping crease may do so also without penalty.

18.4 Unintentional short runs

Except in the circumstances of clause 18.5,

- 18.4.1 if either batsman runs a short run, the umpire concerned shall, unless a boundary is scored, call and signal Short run as soon as the ball becomes dead and that run shall not be scored.
- 18.4.2 if, after either or both batsmen run short, a boundary is scored the umpire concerned shall disregard the short running and shall not call or signal Short run.
- 18.4.3 if both batsmen run short in one and the same run, this shall be regarded as only one short run.
- 18.4.4 if more than one run is short then, subject to clauses 18.4.2 and 18.4.3, all runs called as short shall not be scored.
- 18.4.5 if there has been more than one short run, the umpire shall inform the scorers as to the number of runs to be recorded.

18.5 Deliberate short runs

- 18.5.1 If either umpire considers that one or both batsmen deliberately ran short at that umpire's end, the umpire concerned shall, when the ball is dead, call and signal Short run and inform the other umpire of what has occurred and apply clause 18.5.2.
- 18.5.2 The bowler's end umpire shall
- disallow all runs to the batting side
 - return any not out batsman to his original end
 - signal No ball or Wide to the scorers, if applicable
 - award 5 Penalty runs to the fielding side
 - award any other 5-run Penalty that is applicable except for Penalty runs under clause 28.3 (Protective helmets belonging to the fielding side)
 - inform the scorers as to the number of runs to be recorded, and
 - inform the captain of the fielding side and, as soon as practicable, the captain of the batting side of the reason for this action.

18.6 Runs awarded for penalties

Runs shall be awarded for penalties under clauses 18.5 (Deliberate short runs), 21 (No ball), 22 (Wide ball), 24.4 (Player returning without permission), 26.4 (Penalties for contravention), 28.2 (Fielding the ball), 28.3 (Protective helmets belonging to the fielding side) 41 (Unfair play) and 42 (Players' conduct). Note, however, the restrictions on the award of Penalty runs in clauses 23.3 (Leg byes not to be awarded), 28.3 (Protective helmets belonging to the fielding side) and 34 (Hit the ball twice).

18.7 Runs scored for boundaries

Runs shall be scored for boundary allowances under clause 19 (Boundaries).

18.8 Runs scored when a batsman is dismissed

When a batsman is dismissed, any runs for penalties awarded to either side shall stand.

No other runs shall be credited to the batting side, except as follows.

- 18.8.1 If a batsman is dismissed Obstructing the field, the batting side shall also score any runs completed before the offence.
- If, however, the obstruction prevented a catch being made, no runs other than penalties shall be scored.
- 18.8.2 If a batsman is dismissed Run out, the batting side shall also score any runs completed before the wicket was put down.

18.9 Runs scored when the ball becomes dead other than at the fall of a wicket

When the ball becomes dead for any reason other than the fall of a wicket, or is called dead by an umpire, unless there is specific provision otherwise in these Playing Conditions, any runs for penalties awarded to either side shall be scored. Note however the provisions of clauses 23.3 (Leg byes not to be awarded) and 28.3 (Protective helmets belonging to the fielding side).

Additionally the batting side shall be credited with all runs completed by the batsmen before the incident or call of Dead ball and the run in progress if the batsmen had already crossed at the instant of the incident or call of Dead ball. Note specifically, however, the provisions of clause 41.5.8 (Deliberate distraction, deception or obstruction of batsman).

18.10 Crediting of runs scored

Unless stated otherwise in these Playing Conditions,

- 18.10.1 if the ball is struck by the bat, all runs scored by the batting side shall be credited to the striker, except for the following:
- an award of 5 Penalty runs, which shall be scored as Penalty runs
 - the one run penalty for a No ball, which shall be scored as a No balls extra.
- 18.10.2 if the ball is not struck by the bat, runs shall be scored as Penalty runs, Byes, Leg byes, No ball extras or Wides as the case may be. If Byes or Leg byes accrue from a No ball, only the one run penalty for No ball shall be scored as such, and the remainder as Byes or Leg byes as appropriate.

18.10.3 the bowler shall be debited with:

- all runs scored by the striker
- all runs scored as No ball extras
- all runs scored as Wides.

18.11 Batsman returning to original end

18.11.1 When the striker is dismissed in any of the circumstances in clauses 18.11.1.1 to 18.11.1.5, the not out batsman shall return to his original end.

- 18.11.1.1 Bowled.
- 18.11.1.2 Stumped.
- 18.11.1.3 Hit the ball twice.
- 18.11.1.4 LBW.
- 18.11.1.5 Hit wicket.

18.11.2 The batsmen shall return to their original ends in any of the cases of clauses 18.11.2.1 to 18.11.2.3.

- 18.11.2.1 A boundary is scored.
- 18.11.2.2 Runs are disallowed for any reason.
- 18.11.2.3 A decision by the batsmen at the wicket to do so, under clause 41.5 (Deliberate distraction, deception or obstruction of batsman).

18.12 Batsman returning to wicket he has left

18.12.1 When a batsman is dismissed in any of the ways in clauses 18.12.1.1 to 18.12.1.3, the not out batsman shall return to the wicket he has left but only if the batsmen had not already crossed at the instant of the incident causing the dismissal. If runs are to be disallowed, however, the not out batsman shall return to his original end.

- 18.12.1.1 Caught.
- 18.12.1.2 Obstructing the field.
- 18.12.1.3 Run out.

18.12.2 If, while a run is in progress, the ball becomes dead for any reason other than the dismissal of a batsman, the batsmen shall return to the wickets they had left, but only if they had not already crossed in running when the ball became dead. If, however, any of the circumstances of clauses 18.11.2.1 to 18.11.2.3 apply, the batsmen shall return to their original ends.

19 BOUNDARIES

19.1 Determining the boundary of the field of play

- 19.1.1 Before the toss, the umpires shall determine the boundary of the field of play, which shall be fixed for the duration of the match. See clause 2.3.4 (Consultation with Home Board).
- 19.1.2 The boundary shall be determined such that no part of any sight-screen, will, at any stage of the match, be within the field of play.
- 19.1.3 The aim shall be to maximize the size of the playing area at each venue. With respect to the size of the boundaries, no boundary shall be longer than 90 yards (82.29 meters), and no boundary should be shorter than 65 yards (59.43 metres) from the centre of the pitch to be used.
- 19.1.4 At all times, there must be 3 yards (2.74 meters) from the boundary rope to the first solid object (advertising boards/LEDs, photographers, cameramen, dug outs, covers, perimeter fence) for the player's safety run off.
- 19.1.5 If the boundary is positioned less than 90 yards (82.29 meters) from the centre of the pitch, the boundary rope cannot be set at a distance of more than 10 yards (9.14 meters) from the perimeter fence. The 10 yards shall be inclusive of the 3 yards (2.74 meters) provided for the player's safety run off.
- 19.1.6 Any ground which has previously been approved to host international cricket which is unable to conform to the minimum boundary dimension shall be exempt. In such cases the boundary shall be positioned so as to maximize the size of the playing area.

19.2 Identifying and marking the boundary

- 19.2.1 All boundaries must be designated by a rope, or similar object of a minimum standard as authorised by the ICC from time to time.
- 19.2.2 If the boundary is marked by means of an object that is in contact with the ground the boundary will be the edge of the grounded part of the object which is nearest the pitch.
- 19.2.3 An obstacle within the field of play shall not be regarded as a boundary unless so determined by the umpires before the toss. See clause 2.3.4 (Consultation with Home Board).
- 19.2.4 If an unauthorized person enters the playing arena and handles the ball, the umpire at the bowler's end shall be the sole judge of whether the boundary allowance should be scored or the ball be treated as still in play or called dead ball if a batsman is liable to be out as a result of the unauthorized person handling the ball.

19.3 Restoring the boundary

If a solid object used to mark the boundary is disturbed for any reason, then:

- 19.3.1 the boundary shall be considered to be in its original position.
- 19.3.2 the object shall be returned to its original position as soon as is practicable; if play is taking place, this shall be as soon as the ball is dead.

- 19.3.3 if some part of a fence or other marker has come within the field of play, that part shall be removed from the field of play as soon as is practicable; if play is taking place, this shall be as soon as the ball is dead.

19.4 Ball grounded beyond the boundary

- 19.4.1 The ball in play is grounded beyond the boundary if it touches
- the boundary or any part of an object used to mark the boundary;
 - the ground beyond the boundary;
 - any object that is grounded beyond the boundary.
- 19.4.2 The ball in play is to be regarded as being grounded beyond the boundary if
- a fielder, grounded beyond the boundary as in clause 19.5, touches the ball;
 - a fielder, after catching the ball within the boundary, becomes grounded beyond the boundary while in contact with the ball, before completing the catch.

19.5 Fielder grounded beyond the boundary

- 19.5.1 A fielder is grounded beyond the boundary if some part of his person is in contact with any of the following:
- the boundary or any part of an object used to mark the boundary;
 - the ground beyond the boundary;
 - any object that is in contact with the ground beyond the boundary;
 - another fielder who is grounded beyond the boundary.
- 19.5.2 A fielder who is not in contact with the ground is considered to be grounded beyond the boundary if his final contact with the ground, before his first contact with the ball after it has been delivered by the bowler, was not entirely within the boundary.

19.6 Boundary allowances

- 19.6.1 6 runs shall be allowed for a boundary 6; and 4 runs for a boundary 4. See also clause 19.7.

19.7 Runs scored from boundaries

- 19.7.1 A boundary 6 will be scored if and only if the ball has been struck by the bat and is first grounded beyond the boundary without having been in contact with the ground within the field of play. This shall apply even if the ball has previously touched a fielder.
- 19.7.2 A boundary 4 will be scored when a ball that is grounded beyond the boundary
- whether struck by the bat or not, was first grounded within the boundary, or
 - has not been struck by the bat.

- 19.7.3 When a boundary is scored, the batting side, except in the circumstances of clause 19.8, shall be awarded whichever is the greater of
- 19.7.3.1 the allowance for the boundary
 - 19.7.3.2 the runs completed by the batsmen together with the run in progress if they had already crossed at the instant the boundary is scored.
- 19.7.4 When the runs in clause 19.7.3.2 exceed the boundary allowance they shall replace the boundary allowance for the purposes of clause 18.12.
- 19.7.5 The scoring of Penalty runs by either side is not affected by the scoring of a boundary.

19.8 Overthrow or wilful act of fielder

If the boundary results from an overthrow or from the wilful act of a fielder, the runs scored shall be any runs for penalties awarded to either side and the allowance for the boundary and the runs completed by the batsmen, together with the run in progress if they had already crossed at the instant of the throw or act. Clause 18.12.2 (Batsman returning to wicket he has left) shall apply as from the instant of the throw or act.

20 DEAD BALL

20.1 Ball is dead

- 20.1.1 The ball becomes dead when
- 20.1.1.1 it is finally settled in the hands of the wicket-keeper or of the bowler.
 - 20.1.1.2 a boundary is scored. See clause 19.7 (Runs scored from boundaries).
 - 20.1.1.3 a batsman is dismissed. The ball will be deemed to be dead from the instant of the incident causing the dismissal.
 - 20.1.1.4 whether played or not it becomes trapped between the bat and person of a batsman or between items of his clothing or equipment.
 - 20.1.1.5 whether played or not it lodges in the clothing or equipment of a batsman or the clothing of an umpire.
 - 20.1.1.6 there is an award of Penalty runs under either of clauses 24.4 (Player returning without permission) or 28.2 (Fielding the ball). The ball shall not count as one of the over.
 - 20.1.1.7 there is a contravention of clause 28.3 (Protective helmets belonging to the fielding side).
 - 20.1.1.8 the match is concluded in any of the ways stated in clause 12.6 (Conclusion of match).

- 20.12 The ball shall be considered to be dead when it is clear to the bowler's end umpire that the fielding side and both batsmen at the wicket have ceased to regard it as in play.
- 20.13 In a match where cameras are being used on or over the field of play (e.g. Spidercam), should a ball that has been hit by the batsman make contact, while still in play, with the camera, its apparatus or its cable, either umpire shall call and signal 'dead ball'. The ball shall not count as one of the over and no runs shall be scored. If the delivery was called a No ball it shall count and the No ball penalty shall be applied. No other runs (including penalty runs) apart from the No ball penalty shall be scored.
- 20.14 Should a ball thrown by a fielder make contact with a camera on or over the field of play, its apparatus or its cable, either umpire shall call and signal dead ball. Unless this was already a No ball or Wide, the ball shall count as one of the over. All runs scored to that point shall count, plus the run in progress if the batsmen have already crossed.
- 20.15 Refer also to paragraph 2.6 of Appendix D.

20.2 Ball finally settled

Whether the ball is finally settled or not is a matter for the umpire alone to decide.

20.3 Call of Over or Time

Neither the call of Over (see clause 17.4), nor the call of Time (see clause 12.2) is to be made until the ball is dead, either under clauses 20.1 or 20.4.

20.4 Umpire calling and signalling Dead ball

- 20.4.1 When the ball has become dead under clause 20.1, the bowler's end umpire may call and signal Dead ball if it is necessary to inform the players.
- 20.4.2 Either umpire shall call and signal Dead ball when
- 20.4.2.1 intervening in a case of unfair play.
 - 20.4.2.2 a possibly serious injury to a player or umpire occurs.
 - 20.4.2.3 leaving his/her normal position for consultation.
 - 20.4.2.4 one or both bails fall from the striker's wicket before the striker has had the opportunity of playing the ball.
 - 20.4.2.5 the striker is not ready for the delivery of the ball and, if the ball is delivered, makes no attempt to play it. Provided the umpire is satisfied that the striker had adequate reason for not being ready, the ball shall not count as one of the over.
 - 20.4.2.6 the striker is distracted by any noise or movement or in any other way while preparing to receive, or receiving a delivery. This shall apply whether the source of the distraction is within the match or outside it. Note also clause 20.4.2.7. The ball shall not count as one of the over.

- 20.4.2.7 there is an instance of a deliberate attempt to distract under either of clauses 41.4 (Deliberate attempt to distract striker) or 41.5 (Deliberate distraction, deception or obstruction of batsman). The ball shall not count as one of the over.
- 20.4.2.8 the bowler drops the ball accidentally before delivery.
- 20.4.2.9 the ball does not leave the bowler's hand for any reason other than an attempt to run out the non-striker under clause 41.16 (Non-striker leaving his ground early).
- 20.4.2.10 satisfied that the ball in play cannot be recovered.
- 20.4.2.11 required to do so under any of the Playing Conditions not included above.

20.5 Ball ceases to be dead

The ball ceases to be dead – that is, it comes into play – when the bowler starts his run-up or, if there is no run-up, starts his bowling action.

20.6 Dead ball; ball counting as one of over

- 20.6.1 When a ball which has been delivered is called dead or is to be considered dead then, other than as in clause 20.6.2,
- 20.6.1.1 it will not count in the over if the striker has not had an opportunity to play it.
 - 20.6.1.2 unless No ball or Wide ball has been called, it will be a valid ball if the striker has had an opportunity to play it, except in the circumstances of clauses 20.4.2.6 and 24.4 (Player returning without permission), 28.2 (Fielding the ball), 41.4 (Deliberate attempt to distract striker) and 41.5 (Deliberate distraction, deception or obstruction of batsman).
- 20.6.2 In clause 20.4.2.5, the ball will not count in the over only if both conditions of not attempting to play the ball and having an adequate reason for not being ready are met. Otherwise the delivery will be a valid ball.

21 NO BALL

21.1 Mode of delivery

- 21.1.1 The umpire shall ascertain whether the bowler intends to bowl right handed or left handed, over or round the wicket, and shall so inform the striker.
- It is unfair if the bowler fails to notify the umpire of a change in his mode of delivery. In this case the umpire shall call and signal No ball.
- 21.1.2 Underarm bowling shall not be permitted.

21.2 Fair delivery – the arm

For a delivery to be fair in respect of the arm the ball must not be delivered with an Illegal Bowling Action.

An Illegal Bowling Action is defined as a bowling action where a bowler's Elbow Extension exceeds 15 degrees, measured from the point at which the bowling arm reaches the horizontal until the point at which the ball is released (any Elbow Hyperextension shall be discounted for the purposes of determining an Illegal Bowling Action).

Should either umpire or the ICC Match Referee suspect that a bowler has used an Illegal Bowling Action, they shall complete the ICC Bowling Action Report Form at the conclusion of the match, as set out in the Illegal Bowling Regulations.

21.3 Ball thrown or delivered underarm – action by umpires

21.3.1 If, in the opinion of either umpire, the ball has been thrown (where such mode of delivery does not correspond to the bowler's normal bowling action) or delivered underarm, he/she shall call and signal No ball and, when the ball is dead, inform the other umpire of the reason for the call.

The bowler's end umpire shall then

- warn the bowler, indicating that this is a first and final warning. This warning shall apply to that bowler throughout the innings.
- inform the captain of the fielding side of the reason for this action.
- inform the batsmen at the wicket of what has occurred.

21.3.2 If either umpire considers that, in that innings, a further delivery by the same bowler is thrown (where such mode of delivery does not correspond to the bowler's normal bowling action) or delivered underarm, he/she shall call and signal No ball and when the ball is dead inform the other umpire of the reason for the call.

The bowler's end umpire shall then

- direct the captain of the fielding side to suspend the bowler immediately from bowling. The over shall, if applicable, be completed by another bowler, who shall neither have bowled the previous over or part thereof nor be allowed to bowl any part of the next over. The bowler thus suspended shall not bowl again in that innings.
- inform the batsmen at the wicket and, as soon as practicable, the captain of the batting side of the reason for this action.

21.3.3 The umpires together shall report the occurrence as soon as possible after the match to the ICC Match Referee, who shall take such action as is considered appropriate against the bowler concerned.

21.4 Bowler throwing towards striker's end before delivery

If the bowler throws the ball towards the striker's end before entering the delivery stride, either umpire shall call and signal No ball. See clause 41.17 (Batsmen stealing a run).

However, the procedure stated in clause 21.3 of caution, informing, final warning, action against the bowler and reporting shall not apply.

21.5 Fair delivery – the feet

For a delivery to be fair in respect of the feet, in the delivery stride

- 21.5.1 the bowler's back foot must land within and not touching the return crease appertaining to his stated mode of delivery.
- 21.5.2 the bowler's front foot must land with some part of the foot, whether grounded or raised
- on the same side of the imaginary line joining the two middle stumps as the return crease described in clause 21.5.1, and
 - behind the popping crease.

If the bowler's end umpire is satisfied that any of these three conditions have not been met, he/she shall call and signal No ball. See clause 41.8 (Bowling of deliberate front foot No ball).

21.6 Bowler breaking wicket in delivering ball

Either umpire shall call and signal No ball if, other than in an attempt to run out the non-striker under clause 41.16, the bowler breaks the wicket at any time after the ball comes into play and before completion of the stride after the delivery stride. This shall include any clothing or other object that falls from his person and breaks the wicket.

21.7 Ball bouncing more than once, rolling along the ground or pitching off the pitch

The umpire shall call and signal No ball if a ball which he/she considers to have been delivered, without having previously touched bat or person of the striker,

- bounces more than once.
- or rolls along the ground before it reaches the popping crease.
- or pitches wholly or partially off the pitch as defined in clause 6.1 (Area of pitch) before it reaches the line of the striker's wicket.

21.8 Ball coming to rest in front of striker's wicket

If a ball delivered by the bowler comes to rest in front of the line of the striker's wicket, without having previously touched the bat or person of the striker, the umpire shall call and signal No ball and immediately call and signal Dead ball.

21.9 Fielder intercepting a delivery

If, except in the circumstances of clause 27.3 (Position of wicket-keeper) a ball delivered by the bowler, makes contact with any part of a fielder's person before it either makes contact with the striker's bat or person, or it passes the striker's wicket, the umpire shall call and signal No ball and immediately call and signal Dead ball.

21.10 Ball bouncing over head height of striker

See clauses 22.1.1.2 and 41.6.1.7.

21.11 Call of No ball for infringement of other Playing Conditions

In addition to the instances above, No ball is to be called and signalled as required by the following clauses:

Clause 27.3 – Position of wicket-keeper.

Clause 28.4 – Limitation of on side fielders.

Clause 28.5 – Fielders not to encroach on pitch.

Clause 41.6 – Bowling of dangerous and unfair short pitched deliveries.

Clause 41.7 – Bowling of dangerous and unfair non-pitching deliveries.

Clause 41.8 – Bowling of deliberate front foot No ball.

21.12 Revoking a call of No ball

An umpire shall revoke the call of No ball if Dead ball is called under any of clauses 20.4.2.4 to 20.4.2.9 (Umpire calling and signaling Dead ball). However, if a no ball is called in breach of clause 20.4.2.7 (41.4 - Deliberate attempt to distract striker before playing the ball or 41.5 – Deliberate attempt of Distraction, Deception or Obstruction of striker after the stroke) the No ball will stand.

21.13 No ball to over-ride Wide

A call of No ball shall over-ride the call of Wide ball at any time. See clauses 22.1(Judging a Wide) and 22.2 (Call and signal of Wide ball).

21.14 Ball not dead

The ball does not become dead on the call of No ball.

21.15 Penalty for a No ball

A penalty of one run shall be awarded instantly on the call of No ball. Unless the call is revoked, the penalty shall stand even if a batsman is dismissed. It shall be in addition to any other runs scored, any boundary allowance and any other runs awarded for penalties.

21.16 Runs resulting from a No ball – how scored

The one run penalty shall be scored as a No ball extra and shall be debited against the bowler. If other Penalty runs have been awarded to either side these shall be scored as stated in clause 41.18 (Penalty runs). Any runs completed by the batsmen or any boundary allowance shall be credited to the striker if the ball has been struck by the bat; otherwise they shall also be scored as Byes or Leg byes as appropriate.

21.17 No ball not to count

A No ball shall not count as one of the over. See clause 17.3 (Validity of balls).

21.18 Out from a No ball

When No ball has been called, neither batsman shall be out under any of the Playing Conditions except clause 34 (Hit the ball twice), clause 37 (Obstructing the field) or clause 38 (Run out).

21.19 Free Hit

- 21.19.1 In addition to the above, the delivery following a No ball called (all modes of No ball) shall be a free hit for whichever batsman is facing it. If the delivery for the free hit is not a legitimate delivery (any kind of No ball or a Wide) then the next delivery will become a free hit for whichever batsman is facing it.
- 21.19.2 For any free hit, the striker can be dismissed only under the circumstances that apply for a No ball, even if the delivery for the free hit is called Wide.
- 21.19.3 Neither field changes nor the exchange of individuals between fielding positions are permitted for free hit deliveries unless:
- 21.19.3.1 There is a change of striker (the provisions of clause 41.2 shall apply), or
- 21.19.3.2 The No ball was the result of a fielding restriction breach, in which case the field may be changed to the extent of correcting the breach.
- 21.19.4 For clarity, the bowler can change his mode of delivery for the free hit delivery. In such circumstances Clause 21.1 shall apply.
- 21.19.5 The umpires will signal a free hit by (after the normal No ball signal) extending one arm straight upwards and moving it in a circular motion.

22 WIDE BALL**22.1 Judging a Wide**

- 22.1.1 If the bowler bowls a ball, not being a No ball, the umpire shall adjudge it a Wide if, according to the definition in clause 22.1.2
- 22.1.1.1 the ball passes wide of where the striker is standing and which also would have passed wide of the striker standing in a normal guard position.
- 22.1.1.2 the ball passes above the head height of the striker standing upright at the popping crease.
- 22.1.2 The ball will be considered as passing wide of the striker unless it is sufficiently within reach for him to be able to hit it with the bat by means of a normal cricket stroke.
- 22.1.3 Umpires are instructed to apply very strict and consistent interpretation in regard to this clause in order to prevent negative bowling wide of the wicket.

22.2 Call and signal of Wide ball

If the umpire adjudges a delivery to be a Wide he/she shall call and signal Wide ball as soon as the ball passes the striker's wicket. It shall, however, be considered to have been a Wide from the instant that the bowler entered his delivery stride, even though it cannot be called Wide until it passes the striker's wicket.

22.3 Revoking a call of Wide ball

- 22.3.1 The umpire shall revoke the call of Wide ball if there is then any contact between the ball and the striker's bat or person before the ball comes into contact with any fielder.
- 22.3.2 The umpire shall revoke the call of Wide ball if a delivery is called a No ball. See clause 21.13 (No ball to over-ride Wide).

22.4 Delivery not a Wide

- 22.4.1 The umpire shall not adjudge a delivery as being a Wide, if the striker, by moving, either causes the ball to pass wide of him, as defined in clause 22.1.2 or brings the ball sufficiently within reach to be able to hit it by means of a normal cricket stroke.
- 22.4.2 The umpire shall not adjudge a delivery as being a Wide if the ball touches the striker's bat or person, but only as the ball passes the striker.

22.5 Ball not dead

The ball does not become dead on the call of Wide ball.

22.6 Penalty for a Wide

A penalty of one run shall be awarded instantly on the call of Wide ball. Unless the call is revoked, see clause 22.3, this penalty shall stand even if a batsman is dismissed, and shall be in addition to any other runs scored, any boundary allowance and any other runs awarded for penalties.

22.7 Runs resulting from a Wide – how scored

All runs completed by the batsmen or a boundary allowance, together with the penalty for the Wide, shall be scored as Wide balls. Apart from any award of 5 Penalty runs, all runs resulting from a Wide shall be debited against the bowler.

22.8 Wide not to count

A Wide shall not count as one of the over. See clause 17.3 (Validity of balls).

22.9 Out from a Wide

When Wide ball has been called, neither batsman shall be out under any of the Playing Conditions except clause 35 (Hit wicket), clause 37 (Obstructing the field), clause 38 (Run out) or clause 39 (Stumped).

23 BYE AND LEG BYE**23.1 Byes**

If the ball, delivered by the bowler, not being a Wide, passes the striker without touching his bat or person, any runs completed by the batsmen from that delivery, or a boundary allowance, shall be credited as Byes to the batting side. Additionally, if the delivery is a No ball, the one run penalty for such a delivery shall be incurred.

23.2 Leg byes

- 23.2.1 If a ball delivered by the bowler first strikes the person of the striker, runs shall be scored only if the umpire is satisfied that the striker has either attempted to play the ball with the bat or tried to avoid being hit by the ball.
- 23.2.2 If the umpire is satisfied that either of these conditions has been met runs shall be scored as follows.
- 23.2.2.1 If there is either no subsequent contact with the striker's bat or person, or only inadvertent contact with the striker's bat or person any runs completed by the batsmen or a boundary allowance shall be credited to the striker in the case of subsequent contact with his bat but otherwise to the batting side as in clause 23.2.3.
- 23.2.2.2 If the striker wilfully makes a lawful second strike, clause 34.3 (Ball lawfully struck more than once) and clause 34.4 (Runs permitted from ball lawfully struck more than once) shall apply.
- 23.2.3 The runs in clause 23.2.2.1, unless credited to the striker, shall be scored as Leg byes.
- Additionally, if the delivery is a No ball, the one run penalty for the No ball shall be incurred.

23.3 Leg byes not to be awarded

If in the circumstance of clause 23.2.1 the umpire considers that neither of the conditions therein has been met, then Leg byes shall not be awarded.

If the ball does not become dead for any other reason, the umpire shall call and signal Dead ball as soon as the ball reaches the boundary or at the completion of the first run.

The umpire shall then:

- disallow all runs to the batting side;
- return any not out batsman to his original end;
- signal No ball to the scorers if applicable;
- award any 5-run Penalty that is applicable except for Penalty runs under clause 28.3 (Protective helmets belonging to the fielding side).

24 FIELDER'S ABSENCE; SUBSTITUTES**24.1 Substitute fielders**

- 24.1.1 The umpires shall allow a substitute fielder
- 24.1.1.1 if they are satisfied that a fielder has been injured or become ill and that this occurred during the match, or
- 24.1.1.2 for any other wholly acceptable reason.
- In all other circumstances, a substitute is not allowed.
- 24.1.2 A substitute shall not bowl or act as captain but may act as wicket-keeper only with the consent of the umpires. Note, however, clause 42.4.1.
- 24.1.3 A nominated player may bowl or field even though a substitute has previously acted for him, subject to clauses 24.2 and 24.3.
- 24.1.4 Squad members of the fielding or batting team who are not playing in the match and who are not acting as substitute fielders shall be required to wear a team training bib whilst on the playing area (including the area between the boundary and the perimeter fencing).

24.2 Fielder absent or leaving the field of play

- 24.2.1 A player going briefly outside the boundary while carrying out any duties as a fielder is not absent from the field of play nor, for the purposes of this clause, is he to be regarded as having left the field of play.
- 24.2.2 If a fielder fails to take the field at the start of play or at any later time, or leaves the field during play,
- 24.2.2.1 an umpire shall be informed of the reason for this absence.
- 24.2.2.2 he shall not thereafter come on to the field of play during a session of play without the consent of the umpire. See clause 24.4. The umpire shall give such consent as soon as it is practicable.
- 24.2.3 If a player is absent from the field for longer than 8 minutes, the following restrictions shall apply to their future participation in the match:
- 24.2.3.1 The player shall not be permitted to bowl in the match until he has either been able to field, or his team has subsequently been batting, for the total length of playing time for which the player was absent (hereafter referred to as Penalty time). A player's unexpired Penalty time shall be limited to a maximum of 40 minutes. If any unexpired Penalty time remains at the end of an innings, it is carried forward to the next and subsequent innings of the match.

- 24.2.3.2 The player shall not be permitted to bat in the match until his team's batting innings has been in progress for the length of playing time that is equal to the unexpired Penalty time carried forward from the previous innings. However, once his side has lost five wickets in its batting innings, he may bat immediately. If any unexpired penalty time remains at the end of that batting innings, it is carried forward to the next and subsequent innings of the match.

- 24.2.4 If the player leaves the field before having served all of his Penalty time, the balance is carried forward as unserved Penalty time.
- 24.2.5 On any occasion of absence, the amount of playing time for which the player is off the field shall be added to any Penalty time that remains unserved, subject to a maximum cumulative Penalty time of 40 minutes, and that player shall not bowl until all of his Penalty time has been served.
- 24.2.6 For the purposes of clauses 24.2.3.1 and 24.2.3.2, playing time shall comprise the time play is in progress excluding intervals between innings. For clarity, a player's Penalty time will continue to expire after he is dismissed, for the remainder of his team's batting innings.
- 24.2.7 If there is an unscheduled break in play, the stoppage time shall count as Penalty time served, provided that,
- 24.2.7.1 the fielder who was on the field of play at the start of the break either takes the field on the resumption of play, or his side is now batting.
- 24.2.7.2 the fielder who was already off the field at the start of the break notifies an umpire in person as soon as he is able to participate, and either takes the field on the resumption of play, or his side is now batting. Stoppage time before an umpire has been so notified shall not count towards unserved Penalty time.
- 24.2.8 Any unserved Penalty time shall be carried forward into the next innings of the match, as applicable.

24.3 Penalty time not incurred

- A nominated player's absence will not incur Penalty time if,
- 24.3.1 he has suffered an external blow during the match and, as a result, has justifiably left the field or is unable to take the field.
- 24.3.2 in the opinion of the umpires, the player has been absent or has left the field for other wholly acceptable reasons, which shall not include illness or internal injury.
- 24.3.3 the player is absent from the field for a period of 8 minutes or less.

24.4 Player returning without permission

If a player comes on to the field of play in contravention of clause 24.2.2 and comes into contact with the ball while it is in play, the ball shall immediately become dead.

- The umpire shall award 5 Penalty runs to the batting side.
- Runs completed by the batsmen shall be scored together with the run in progress if they had already crossed at the instant of the offence.
- The ball shall not count as one of the over.
- The umpire shall inform the other umpire, the captain of the fielding side, the batsmen and, as soon as practicable, the captain of the batting side of the reason for this action.

25 BATSMAN'S INNINGS**25.1 Eligibility to act as a batsman**

Only a nominated player may bat and, subject to clause 25.3, may do so even though a substitute fielder has previously acted for him.

25.2 Commencement of a batsman's innings

The innings of the first two batsmen, and that of any new batsman on the resumption of play after a call of Time, shall commence at the call of Play. At any other time, a batsman's innings shall be considered to have commenced when that batsman first steps onto the field of play.

25.3 Restriction on batsman commencing an innings

- 25.3.1 If a member of the batting side has unserved Penalty time, (see clause 24.2.7), that player shall not be permitted to bat until that Penalty time has been served. However, even if the unserved Penalty time has not expired, that player may bat after his side has lost 5 wickets.
- 25.3.2 A member of the batting side's Penalty time is served during Playing time. In the event of an unscheduled stoppage, the stoppage time after the batsman notifies an umpire in person that he is able to participate shall count as Penalty time served.

25.4 Batsman retiring

- 25.4.1 A batsman may retire at any time during his innings when the ball is dead. The umpires, before allowing play to proceed, shall be informed of the reason for a batsman retiring.
- 25.4.2 If a batsman retires because of illness, injury or any other unavoidable cause, that batsman is entitled to resume his innings. If for any reason this does not happen, that batsman is to be recorded as 'Retired – not out'.
- 25.4.3 If a batsman retires for any reason other than as in clause 25.4.2, the innings of that batsman may be resumed only with the consent of the opposing captain. If for any reason his innings is not resumed, that batsman is to be recorded as 'Retired – out'.

- 25.4.4 If after retiring a batsman resumes his innings, subject to the requirements of clauses 25.4.2 and 25.4.3, it shall be only at the fall of a wicket or the retirement of another batsman.

25.5 Runners

Runners shall not be permitted.

26 PRACTICE ON THE FIELD**26.1 Practice on the pitch or the rest of the square**

- 26.1.1 There shall not be any practice on the pitch at any time.
- 26.1.2 There shall not be any practice on the rest of the square at any time except with the approval of the umpires.
- 26.1.2.1 If approved by the umpires, the use of the square for practice on any day of any match will be restricted to any netted practice area or bowling strips specifically prepared on the edge of the square for that purpose.
- 26.1.2.2 Bowling practice on the bowling strips referred to above shall also be permitted during the interval (and change of innings if not the interval) unless the umpires consider that, in the prevailing conditions of ground and weather, it will be detrimental to the surface of the square.

26.2 Practice on the outfield

- 26.2.1 On any day of the match, all forms of practice are permitted on the outfield
- before the start of play;
 - after the close of play; and
 - during the interval or between innings
- providing the umpires are satisfied that such practice will not cause significant deterioration in the condition of the outfield.
- 26.2.2 Between the call of Play and the call of Time, practice shall be permitted on the outfield, providing that all of the following conditions are met:
- only the fielders as defined in paragraph 7 of Appendix A participate in such practice.
 - no ball other than the match ball is used for this practice.
 - no bowling practice takes place in the area between the square and the boundary in a direction parallel to the match pitch.
 - the umpires are satisfied that it will not contravene either of clauses 41.3 (The match ball changing its condition) or 41.9 (Time wasting by the fielding side).

Bowling a ball, using a short run up to a player in the outfield is not to be regarded as bowling practice but shall be subject to the other conditions in this clause.

26.3 Trial run-up

A bowler is permitted to have a trial run-up provided the umpire is satisfied that it will not contravene either of clauses 41.9 (Time wasting by the fielding side) or 41.12 (Fielder damaging the pitch).

26.4 Penalties for contravention

All forms of practice are subject to the provisions of clauses 41.3 (The match ball – changing its condition), 41.9 (Time wasting by the fielding side) and 41.12 (Fielder damaging the pitch).

26.4.1 If there is a contravention of any of the provisions of clause 26.1 or 26.2, the umpire shall

- warn the player that the practice is not permitted;
- inform the other umpire and, as soon as practicable, both captains of the reason for this action.

26.4.1.1 If the contravention is by a batsman at the wicket, the umpire shall inform the other batsman and each incoming batsman that the warning has been issued. The warning shall apply to the team of that player throughout the match.

26.4.2 If during the match there is any further contravention by any player of that team, the umpire shall

- award 5 Penalty runs to the opposing side;
- inform the other umpire, the scorers and, as soon as practicable, both captains, and, if the contravention is during play, the batsmen at the wicket.

27 THE WICKET-KEEPER**27.1 Protective equipment**

The wicket-keeper is the only fielder permitted to wear gloves and external leg guards. If these are worn, they are to be regarded as part of his person for the purposes of clause 28.2 (Fielding the ball). If by the wicket-keeper's actions and positioning when the ball comes into play it is apparent to the umpires that he will not be able to carry out the normal duties of a wicket-keeper, he shall forfeit this right and also the right to be recognised as a wicket-keeper for the purposes of clauses 33.2 (A fair catch), 39 (Stumped), 28.1 (Protective equipment), 28.4 (Limitation of on-side fielders) and 28.5 (Fielders not to encroach on pitch).

27.2 Gloves

27.2.1 If, as permitted under clause 27.1, the wicket-keeper wears gloves, they shall have no webbing between the fingers except joining index finger and thumb, where webbing may be inserted as a means of support.

27.2.2 If used, the webbing shall be a single piece of non-stretch material which, although it may have facing material attached, shall have no reinforcements or tucks.

27.2.3 The top edge of the webbing shall not protrude beyond the straight line joining the top of the index finger to the top of the thumb and shall be taut when a hand wearing the glove has the thumb fully extended. See paragraph 3 of Appendix B.

27.3 Position of wicket-keeper

27.3.1 The wicket-keeper shall remain wholly behind the wicket at the striker's end from the moment the ball comes into play until a ball delivered by the bowler

touches the bat or person of the striker; or

passes the wicket at the striker's end; or

the striker attempts a run.

27.3.2 In the event of the wicket-keeper contravening this clause, the striker's end umpire shall call and signal No ball as soon as applicable after the delivery of the ball.

27.4 Movement by wicket-keeper

27.4.1 After the ball comes into play and before it reaches the striker, it is unfair if the wicket-keeper significantly alters his position in relation to the striker's wicket, except for the following:

27.4.1.1 movement of a few paces forward for a slower delivery, unless in so doing it brings him within reach of the wicket.

27.4.1.2 lateral movement in response to the direction in which the ball has been delivered.

27.4.1.3 movement in response to the stroke that the striker is playing or that his actions suggest he intends to play. However the provisions of clause 27.3 shall apply.

27.4.2 In the event of unfair movement by the wicket-keeper, either umpire shall call and signal Dead ball.

27.5 Restriction on actions of wicket-keeper

If, in the opinion of either umpire, the wicket-keeper interferes with the striker's right to play the ball and to guard his wicket, clause 20.4.2.6 (Umpire calling and signalling Dead ball) shall apply.

If, however, either umpire considers that the interference by the wicket-keeper was wilful, then clause 41.1 (Deliberate attempt to distract striker) shall also apply.

27.6 Interference with wicket-keeper by striker

If, in playing at the ball or in the legitimate defence of his wicket, the striker interferes with the wicket-keeper, he shall not be out except as provided for in clause 37.3 (Obstructing a ball from being caught).

28 THE FIELDER**28.1 Protective equipment**

No fielder other than the wicket-keeper shall be permitted to wear gloves or external leg guards. In addition, protection for the hand or fingers may be worn only with the consent of the umpires.

28.2 Fielding the ball

- 28.2.1 A fielder may field the ball with any part of his person (see paragraph 12 of Appendix A), except as in clause 28.2.1.2. However, he will be deemed to have fielded the ball illegally if, while the ball is in play he wilfully
- 28.2.1.1 uses anything other than part of his person to field the ball.
- 28.2.1.2 extends his clothing with his hands and uses this to field the ball.
- 28.2.1.3 discards a piece of clothing, equipment or any other object which subsequently makes contact with the ball.
- 28.2.2 It is not illegal fielding if the ball in play makes contact with a piece of clothing, equipment or any other object which has accidentally fallen from the fielder's person.
- 28.2.3 If a fielder illegally fields the ball, the ball shall immediately become dead and
- the penalty for a No ball or a Wide shall stand.
 - any runs completed by the batsmen shall be credited to the batting side, together with the run in progress if the batsmen had already crossed at the instant of the offence.
 - the ball shall not count as one of the over.
- In addition the umpire shall:
- award 5 Penalty runs to the batting side.
 - inform the other umpire and the captain of the fielding side of the reason for this action.
 - inform the batsmen and, as soon as practicable, the captain of the batting side of what has occurred.

28.3 Protective helmets belonging to the fielding side

- 28.3.1 Protective helmets, when not in use by fielders, may not be placed on the ground, above the surface except behind the wicket-keeper and in line with both sets of stumps.
- 28.3.2 If the ball while in play strikes a helmet, placed as described in clause 28.3.1,
- 28.3.2.1 the ball shall become dead and, subject to clause 28.3.3,
- 28.3.2.2 an award of 5 Penalty runs shall be made to the batting side;

- 28.3.2.3 any runs completed by the batsmen before the ball strikes the protective helmet shall be scored, together with the run in progress if the batsmen had already crossed at the instant of the ball striking the protective helmet.

- 28.3.3 If the ball while in play strikes a helmet, placed as described in clause 28.3.1, unless the circumstances of clause 23.3 (Leg byes not to be awarded) or clause 34 (Hit the ball twice), apply, the umpire shall:
- permit the batsmen's runs as in clause 28.3.2.3 to be scored
 - signal No ball or Wide ball to the scorers if applicable
 - award 5 Penalty runs as in clause 28.3.2.2
 - award any other Penalty runs due to the batting side.
- 28.3.4 If the ball while in play strikes a helmet, placed as described in clause 28.3.1, and the circumstances of clause 23.3 (Leg byes not to be awarded) or clause 34 (Hit the ball twice) apply, the umpire shall:
- disallow all runs to the batting side
 - return any not out batsman to his original end
 - signal No ball or Wide ball to the scorers if applicable
 - award any 5-run Penalty that is applicable except for Penalty runs under clause 28.3.2.

28.4 Limitation of on side fielders

- 28.4.1 At the instant of delivery, there may not be more than 5 fielders on the leg side.
- 28.4.2 At the instant of the bowler's delivery there shall not be more than two fielders, other than the wicket-keeper, behind the popping crease on the on side. A fielder will be considered to be behind the popping crease unless the whole of his person whether grounded or in the air is in front of this line.
- 28.4.3 In the event of infringement of this clause by any fielder, the striker's end umpire shall call and signal No ball.

28.5 Fielders not to encroach on pitch

While the ball is in play and until the ball has made contact with the striker's bat or person, or has passed the striker's bat, no fielder, other than the bowler, may have any part of his person grounded on or extended over the pitch.

In the event of infringement of this clause by any fielder other than the wicket-keeper, the bowler's end umpire shall call and signal No ball as soon as possible after delivery of the ball. Note, however, clause 27.3 (Position of wicket-keeper).

28.6 Movement by any fielder other than the wicket-keeper

- 28.6.1 Any movement by any fielder, excluding the wicket-keeper, after the ball comes into play and before the ball reaches the striker, is unfair except for the following:
- 28.6.1.1 minor adjustments to stance or position in relation to the striker's wicket.
- 28.6.1.2 movement by any fielder, other than a close fielder, towards the striker or the striker's wicket that does not significantly alter the position of the fielder.
- 28.6.1.3 movement by any fielder in response to the stroke that the striker is playing or that his actions suggest he intends to play.
- 28.6.2 In all circumstances clause 28.4 (Limitation of on side fielders) shall apply.
- 28.6.3 In the event of such unfair movement, either umpire shall call and signal Dead ball.
- 28.6.4 Note also the provisions of clause 41.4 (Deliberate attempt to distract striker). See also clause 27.4 (Movement by wicket-keeper).

28.7 Restrictions on the placement of fielders

- 28.7.1 In addition to the restrictions contained in clause 28.4 above, further fielding restrictions shall apply to certain overs in each innings. The nature of such fielding restrictions and the overs during which they shall apply are set out in the following paragraphs.
- 28.7.2 Subject to 28.7.6 below these additional fielding restrictions shall apply to the first 6 overs of each innings (Powerplay overs).
- 28.7.3 Two semi-circles shall be drawn on the field of play. The semi-circles shall have as their centre the middle stump at either end of the pitch. The radius of each of the semi-circles shall be 30 yards (27.43 metres). The semi-circles shall be linked by two parallel straight lines drawn on the field (see paragraph 2 of Appendix C). These fielding restriction areas should be marked by continuous painted white lines or 'dots' at 5 yard (4.57 metres) intervals, each 'dot' to be covered by a white plastic or rubber (but not metal) disc measuring 7 inches (18 cm) in diameter.
- 28.7.4 During the Powerplay overs only two fielders shall be permitted outside this fielding restriction area at the instant of delivery.
- 28.7.5 During the non Powerplay overs, no more than 5 fielders shall be permitted outside the fielding restriction area referred to in clause 28.7.3 above.

- 28.7.6 In circumstances when the number of overs of the batting team is reduced, the number of Powerplay overs shall be reduced in accordance with the table below. For the sake of clarity, it should be noted that the table shall apply to both the 1st and 2nd innings of the match.

TOTAL OVERS IN INNINGS	NUMBER OF OVERS FOR WHICH FIELDING RESTRICTIONS IN CLAUSES 28.7.2 AND 28.7.4 ABOVE WILL APPLY
5-8	2
9-11	3
12-14	4
15-18	5
19-20	6

- 28.7.7 If an innings is interrupted during an over and if on the resumption of play, due to the reduced number of overs of the batting team, the required number of Powerplay overs have already been bowled, the remaining deliveries in the over to be completed shall not be subject to the fielding restrictions.
- 28.7.8 In the event of an infringement of any of the above fielding restrictions, the square leg umpire shall call and signal No ball.

29 THE WICKET IS DOWN**29.1 Wicket put down**

- 29.1.1 The wicket is put down if a bail is completely removed from the top of the stumps, or a stump is struck out of the ground,
- 29.1.1.1 by the ball,
- 29.1.1.2 by the striker's bat if held or by any part of the bat that he is holding,
- 29.1.1.3 for the purpose of this clause only, by the striker's bat not in hand, or by any part of the bat which has become detached,
- 29.1.1.4 by the striker's person or by any part of his clothing or equipment becoming detached from his person,
- 29.1.1.5 by a fielder with his hand or arm, providing that the ball is held in the hand or hands so used, or in the hand of the arm so used.
- 29.1.1.6 The wicket is also put down if a fielder strikes or pulls a stump out of the ground as in clause 29.1.1.5.
- 29.1.2 The disturbance of a bail, whether temporary or not, shall not constitute its complete removal from the top of the stumps, but if a bail in falling lodges between two of the stumps this shall be regarded as complete removal.

29.2 One bail off

If one bail is off, it shall be sufficient for the purpose of putting the wicket down to remove the remaining bail or to strike or pull any of the three stumps out of the ground, in any of the ways stated in clause 29.1.

29.3 Remaking wicket

If a wicket is broken or put down while the ball is in play, it shall not be remade by an umpire until the ball is dead. See clause 20 (Dead ball). Any fielder may, however, while the ball is in play,

- replace a bail or bails on top of the stumps.
- put back one or more stumps into the ground where the wicket originally stood.

29.4 Dispensing with bails

If the umpires have agreed to dispense with bails in accordance with clause 8.5 (Dispensing with bails), it is for the umpire concerned to decide whether or not the wicket has been put down.

- 29.4.1 After a decision to play without bails, the wicket has been put down if the umpire concerned is satisfied that the wicket has been struck by the ball, by the striker's bat, person or items of his clothing or equipment as described in clauses 29.1.1.2, 29.1.1.3 or 29.1.1.4, or by a fielder in the manner described in clause 29.1.1.5.
- 29.4.2 If the wicket has already been broken or put down, clause 29.4.1 shall apply to any stump or stumps still in the ground. Any fielder may replace a stump or stumps, in accordance with clause 29.3, in order to have an opportunity of putting the wicket down.

30 BATSMAN OUT OF HIS GROUND**30.1 When out of his ground**

- 30.1.1 A batsman shall be considered to be out of his ground unless some part of his person or bat is grounded behind the popping crease at that end.
- 30.1.2 However, a batsman shall not be considered to be out of his ground if, in running or diving towards his ground and beyond, and having grounded some part of his person or bat beyond the popping crease, there is subsequent loss of contact between the ground and any part of his person or bat, or between the bat and person.

30.2 Which is a batsman's ground

- 30.2.1 If only one batsman is within a ground, it is his ground and will remain so even if he is later joined there by the other batsman.
- 30.2.2 If both batsmen are in the same ground and one of them subsequently leaves it, the ground belongs to the batsman who remains in it.

30.2.3 If there is no batsman in either ground, then each ground belongs to whichever batsman is nearer to it, or, if the batsmen are level, to whichever batsman was nearer to it immediately prior to their drawing level.

30.2.4 If a ground belongs to one batsman then the other ground belongs to the other batsman, irrespective of his position.

30.3 Position of non-striker

The non-striker, when standing at the bowler's end, should be positioned on the opposite side of the wicket to that from which the ball is being delivered, unless a request to do otherwise is granted by the umpire.

31 APPEALS**31.1 Umpire not to give batsman out without an appeal**

Neither umpire shall give a batsman out, even though he may be out under these Playing Conditions, unless appealed to by a fielder. This shall not debar a batsman who is out under these Playing Conditions from leaving the wicket without an appeal having been made. Note, however, the provisions of clause 31.7.

31.2 Batsman dismissed

A batsman is dismissed if he is either given out by an umpire, on appeal or out under these Playing Conditions and leaves the wicket as in clause 31.1.

31.3 Timing of appeals

For an appeal to be valid, it must be made before the bowler begins his run-up or, if there is no run-up, his bowling action to deliver the next ball, and before Time has been called.

The call of Over does not invalidate an appeal made prior to the start of the following over, provided Time has not been called. See clauses 12.2 (Call of Time) and 17.2 (Start of an over).

31.4 Appeal "How's That?"

An appeal "How's That?" covers all ways of being out.

31.5 Answering appeals

The striker's end umpire shall answer all appeals arising out of any of clauses 35 (Hit wicket), 39 (Stumped) or 38 (Run out) when this occurs at the wicket-keeper's end. The bowler's end umpire shall answer all other appeals.

When an appeal is made, each umpire shall answer on any matter that falls within his jurisdiction.

When a batsman has been given Not out, either umpire may answer an appeal, made in accordance with clause 31.3, if it is on a further matter and is within his jurisdiction.

31.6 Consultation by umpires

Each umpire shall answer appeals on matters within his own jurisdiction. If an umpire is doubtful about any point that the other umpire may have been in a better position to see, he/she shall consult the latter on this point of fact and shall then give the decision. If, after consultation, there is still doubt remaining, the decision shall be Not out.

31.7 Batsman leaving the wicket under a misapprehension

An umpire shall intervene if satisfied that a batsman, not having been given out, has left the wicket under a misapprehension of being out. The umpire intervening shall call and signal Dead ball to prevent any further action by the fielding side and shall recall the batsman.

A batsman may be recalled at any time up to the instant when the ball comes into play for the next delivery, unless it is the final wicket of the innings, in which case it should be up to the instant when the umpires leave the field.

31.8 Withdrawal of an appeal

The captain of the fielding side may withdraw an appeal only after obtaining the consent of the umpire within whose jurisdiction the appeal falls. If such consent is given, the umpire concerned shall, if applicable, revoke the decision and recall the batsman.

The withdrawal of an appeal must be before the instant when the ball comes into play for the next delivery or, if the innings has been completed, the instant when the umpires leave the field.

32 BOWLED**32.1 Out Bowled**

32.1.1 The striker is out Bowled if his wicket is put down by a ball delivered by the bowler, not being a No ball, even if it first touches the striker's bat or person.

32.1.2 However, the striker shall not be out Bowled if before striking the wicket the ball has been in contact with any other player or an umpire. The striker will, however, be subject to clauses 37 (Obstructing the field), 38 (Run out) and 39 (Stumped).

32.2 Bowled to take precedence

The striker is out Bowled if his wicket is put down as in clause 32.1, even though a decision against him for any other method of dismissal would be justified.

33 CAUGHT**33.1 Out Caught**

The striker is out Caught if a ball delivered by the bowler, not being a No ball, touches his bat without having previously been in contact with any fielder, and is subsequently held by a fielder as a fair catch, as described in clause 33.2 and 33.3, before it touches the ground.

33.2 A fair catch

33.2.1 A catch will be fair only if, in every case either the ball, at any time or any fielder in contact with the ball,

is not grounded beyond the boundary before the catch is completed. Note clauses 19.4 (Ball grounded beyond the boundary) and 19.5 (Fielder grounded beyond the boundary).

33.2.2 Furthermore, a catch will be fair if any of the following conditions applies:

33.2.2.1 the ball is held in the hand or hands of a fielder, even if the hand holding the ball is touching the ground, or is hugged to the body, or lodges in the external protective equipment worn by a fielder, or lodges accidentally in a fielder's clothing.

33.2.2.2 a fielder catches the ball after it has been lawfully struck more than once by the striker, but only if it has not been grounded since it was first struck. See clause 34 (Hit the ball twice).

33.2.2.3 a fielder catches the ball after it has touched the wicket, an umpire, another fielder or the other batsman.

33.2.2.4 a fielder catches the ball after it has crossed the boundary in the air, provided that the conditions in clause 33.2.1 are met.

33.2.2.5 the ball is caught off an obstruction within the boundary that is not designated a boundary by the umpires.

33.3 Making a catch

The act of making a catch shall start from the time when the ball first comes into contact with a fielder's person and shall end when a fielder obtains complete control over both the ball and his own movement.

33.4 No runs to be scored

If the striker is dismissed Caught, runs from that delivery completed by the batsmen before the completion of the catch shall not be scored but any runs for penalties awarded to either side shall stand. Clause 18.11.1 (Batsman returning to wicket he has left) shall apply from the instant of the completion of the catch.

33.5 Caught to take precedence

If the criteria of clause 33.1 are met and the striker is not out Bowled, then he is out Caught, even though a decision against either batsman for another method of dismissal would be justified.

34 HIT THE BALL TWICE**34.1 Out Hit the ball twice**

- 34.1.1 The striker is out Hit the ball twice if, while the ball is in play, it strikes any part of his person or is struck by his bat and, before the ball has been touched by a fielder, the striker wilfully strikes it again with his bat or person, other than a hand not holding the bat, except for the sole purpose of guarding his wicket. See clause 34.3 and clause 37 (Obstructing the field).
- 34.1.2 For the purpose of this clause 'struck' or 'strike' shall include contact with the person of the striker.

34.2 Not out Hit the ball twice

The striker will not be out under this clause if he

- 34.2.1 strikes the ball a second or subsequent time in order to return the ball to any fielder.
Note, however, the provisions of clause 37.4 (Returning the ball to a fielder).
- 34.2.2 wilfully strikes the ball after it has touched a fielder. Note, however the provisions of clause 37.1 (Out Obstructing the field).

34.3 Ball lawfully struck more than once

The striker may, solely in order to guard his wicket and before the ball has been touched by a fielder, lawfully strike the ball a second or subsequent time with the bat, or with any part of his person other than a hand not holding the bat. The striker may guard his wicket even if the delivery is a No ball.

However, the striker may not prevent the ball from being caught by striking the ball more than once in defence of his wicket. See clause 37.3 (Obstructing a ball from being caught).

34.4 Runs permitted from ball lawfully struck more than once

When the ball is lawfully struck more than once, as permitted in clause 34.3, if the ball does not become dead for any reason, the umpire shall call and signal Dead ball as soon as the ball reaches the boundary or at the completion of the first run. However, the umpire shall delay the call of Dead ball to allow the opportunity for a catch to be completed.

The umpire shall

- disallow all runs to the batting side
- return any not out batsman to his original end
- signal No ball to the scorers if applicable; and
- award any 5-run Penalty that is applicable except for Penalty runs under clause 28.3 (Protective helmets belonging to the fielding side).

34.5 Bowler does not get credit

The bowler does not get credit for the wicket.

35 HIT WICKET**35.1 Out Hit wicket**

- 35.1.1 The striker is out Hit wicket if, after the bowler has entered the delivery stride and while the ball is in play, his wicket is put down by either the striker's bat or person as described in clauses 29.1.1.2 to 29.1.1.4 (Wicket put down) in any of the following circumstances:
- 35.1.1.1 in the course of any action taken by him in preparing to receive or in receiving a delivery,
- 35.1.1.2 in setting off for the first run immediately after playing or playing at the ball,
- 35.1.1.3 if no attempt is made to play the ball, in setting off for the first run, providing that in the opinion of the umpire this is immediately after the striker has had the opportunity of playing the ball,
- 35.1.1.4 in lawfully making a second or further stroke for the purpose of guarding his wicket within the provisions of clause 34.3 (Ball lawfully struck more than once).
- 35.1.2 If the striker puts his wicket down in any of the ways described in clauses 29.1.1.2 to 29.1.1.4 before the bowler has entered the delivery stride, either umpire shall call and signal Dead ball.

35.2 Not out Hit wicket

The striker is not out under this clause should his wicket be put down in any of the ways referred to in clause 35.1 if any of the following applies:

- it occurs after the striker has completed any action in receiving the delivery, other than in clauses 35.1.1.2 to 35.1.1.4.
- it occurs when the striker is in the act of running, other than setting off immediately for the first run.
- it occurs when the striker is trying to avoid being run out or stumped.
- it occurs when the striker is trying to avoid a throw in at any time.
- the bowler after entering the delivery stride does not deliver the ball. In this case either umpire shall immediately call and signal Dead ball. See clause 20.4 (Umpire calling and signalling Dead ball).
- the delivery is a No ball.

36 LEG BEFORE WICKET**36.1 Out LBW**

The striker is out LBW if all the circumstances set out in clauses 36.1.1 to 36.1.5 apply.

- 36.1.1 The bowler delivers a ball, not being a No ball
- 36.1.2 the ball, if it is not intercepted full-pitch, pitches in line between wicket and wicket or on the off side of the striker's wicket
- 36.1.3 the ball not having previously touched his bat, the striker intercepts the ball, either full-pitch or after pitching, with any part of his person

- 36.14 the point of impact, even if above the level of the bails, either is between wicket and wicket or if the striker has made no genuine attempt to play the ball with the bat, is between wicket and wicket or outside the line of the off stump.
- 36.15 but for the interception, the ball would have hit the wicket.

36.2 Interception of the ball

- 36.2.1 In assessing points of impact in clauses 36.1.3, 36.1.4 and 36.1.5, only the first interception is to be considered.
- 36.2.2 In assessing 36.1.3, if the bowler's end umpire is not satisfied that the ball intercepted the batsman's person before it touched the bat, the batsman shall be given Not out.
- 36.2.3 In assessing clause 36.1.5, it is to be assumed that the path of the ball before interception would have continued after interception, irrespective of whether the ball might have pitched subsequently or not.

36.3 Off side of wicket

The off side of the striker's wicket shall be determined by the striker's stance at the moment the ball comes into play for that delivery. See paragraph 13 of Appendix A.

37 OBSTRUCTING THE FIELD

37.1 Out Obstructing the field

- 37.1.1 Either batsman is out Obstructing the field if, except in the circumstances of clause 37.2, and while the ball is in play, he wilfully attempts to obstruct or distract the fielding side by word or action. See also clause 34 (Hit the ball twice).
- 37.1.2 The striker is out Obstructing the field if, except in the circumstances of clause 37.2, in the act of receiving a ball delivered by the bowler, he wilfully strikes the ball with a hand not holding the bat. This will apply whether it is the first strike or a second or subsequent strike. The act of receiving the ball shall extend both to playing at the ball and to striking the ball more than once in defence of his wicket.
- 37.1.3 This clause will apply whether or not No ball is called.
- 37.1.4 For the avoidance of doubt, if an umpire feels that a batsman, in running between the wickets, has significantly changed his direction without probable cause and thereby obstructed a fielder's attempt to effect a run out, the batsman should, on appeal, be given out, obstructing the field. It shall not be relevant whether a run out would have occurred or not.
- If the change of direction involves the batsman crossing the pitch, clause 41.14 shall also apply.
- See also paragraph 2.2 of Appendix D.

37.2 Not out Obstructing the field

A batsman shall not be out Obstructing the field if obstruction or distraction is accidental, or obstruction is in order to avoid injury, or in the case of the striker, he makes a second or subsequent strike to guard his wicket lawfully as in clause 34.3 (Ball lawfully struck more than once). However, see clause 37.3.

37.3 Obstructing a ball from being caught

- 37.3.1 If the delivery is not a No ball, the striker is out Obstructing the field if wilful obstruction or distraction by either batsman prevents the striker being out caught.
- 37.3.2 Clause 37.3.1 shall apply even if an obstruction is caused by the striker in lawfully guarding his wicket under the provision of Clause 34.3 (Ball lawfully struck more than once).
- 37.3.3 If an obstruction or distraction takes place from a No ball then the batsman who caused the obstruction or distraction will be out Obstructing the field.
- 37.3.4 Clause 37.3.3 shall not apply if the striker obstructs while instinctively defending his wicket with a lawful second strike.

37.4 Returning the ball to a fielder

Either batsman is out Obstructing the field if, at any time while the ball is in play and, without the consent of a fielder, he uses the bat or any part of his person to return the ball to any fielder.

37.5 Runs scored

When either batsman is dismissed Obstructing the field,

- 37.5.1 unless the obstruction prevents a catch from being made, any runs completed by the batsmen before the offence shall be scored, together with any runs awarded for penalties to either side. See clauses 18.6 (Runs awarded for penalties) and 18.8 (Runs scored when a batsman is dismissed).
- 37.5.2 if the obstruction prevents a catch from being made, any runs completed by the batsmen shall not be scored but any penalties awarded to either side shall stand.

37.6 Bowler does not get credit

The bowler does not get credit for the wicket.

38 RUN OUT

38.1 Out Run out

Either batsman is out Run out, except as in clause 38.2, if, at any time while the ball is in play, he is out of his ground and his wicket is fairly put down by the action of a fielder even though No ball has been called, except in the circumstances of clause 38.2.2.2, and whether or not a run is being attempted.

38.2 Batsman not out Run out

- 38.2.1 A batsman is not out Run out in the circumstances of clauses 38.2.1.1 or 38.2.1.2.
- 38.2.1.1 He has been within his ground and has subsequently left it to avoid injury, when the wicket is put down.
Note also the provisions of clause 30.1.2 (When out of his ground).
- 38.2.1.2 The ball, delivered by the bowler, has not made contact with a fielder, before the wicket is put down.
- 38.2.2 The striker is not out Run out in any of the circumstances in clauses 38.2.2.1 and 38.2.2.2.
- 38.2.2.1 He is out Stumped. See clause 39.1.2 (Out Stumped).
- 38.2.2.2 No ball has been called
and he is out of his ground not attempting a run
and the wicket is fairly put down by the wicket-keeper without the intervention of another fielder.

38.3 Which batsman is out

The batsman out in the circumstances of clause 38.1 is the one whose ground is at the end where the wicket is put down. See clause 30.2 (Which is a batsman's ground).

38.4 Runs scored

If either batsman is dismissed Run out, the run in progress when the wicket is put down shall not be scored, but any runs completed by the batsmen shall stand, together with any runs for penalties awarded to either side. See clauses 18.6 (Runs awarded for penalties) and 18.8 (Runs scored when a batsman is dismissed).

38.5 Bowler does not get credit

The bowler does not get credit for the wicket.

39 STUMPED**39.1 Out Stumped**

- 39.1.1 The striker is out Stumped, except as in clause 39.3, if a ball which is delivered is not called No ball
and he is out of his ground, other than as in clause 39.3.1
and he has not attempted a run
when his wicket is fairly put down by the wicket-keeper without the intervention of another fielder. Note, however clause 27.3 (Position of wicket-keeper).
- 39.1.2 The striker is out Stumped if all the conditions of clause 39.1.1 are satisfied, even though a decision of Run out would be justified.

39.2 Ball rebounding from wicket-keeper's person

If the wicket is put down by the ball, it shall be regarded as having been put down by the wicket-keeper if the ball rebounds on to the stumps from any part of the wicket-keeper's person or equipment or has been kicked or thrown on to the stumps by the wicket-keeper.

39.3 Not out Stumped

- 39.3.1 The striker will not be out Stumped if, after having received the delivery, he has left his ground in order to avoid injury.
- 39.3.2 If the striker is not out Stumped he may, except in the circumstances of clause 38.2.2.2, (Batsman not out Run out), be out Run out if the conditions of clause 38.1 (Out Run out) apply.

40 TIMED OUT**40.1 Out Timed out**

- 40.1.1 After the fall of a wicket or the retirement of a batsman, the incoming batsman must, unless Time has been called, be in position to take guard or for the other batsman to be ready to receive the next ball within 1 minute 30 seconds of the dismissal or retirement. If this requirement is not met, the incoming batsman will be out, Timed out.
- 40.1.2 The incoming batsman is expected to be ready to make his way to the wicket immediately a wicket falls. Dugouts shall be provided.
- 40.1.3 In the event of an extended delay in which no batsman comes to the wicket, the umpires shall adopt the procedure of clause 16.2 (ICC Match Referee awarding a match). For the purposes of that clause the start of the action shall be taken as the expiry of the 1 minute 30 seconds referred to above.

40.2 Bowler does not get credit

The bowler does not get credit for the wicket.

41 UNFAIR PLAY**41.1 Fair and unfair play – responsibility of captains**

The captains are responsible for ensuring that play is conducted within the Spirit of Cricket, as well as within these Playing Conditions.

41.2 Fair and unfair play – responsibility of umpires

- 41.2.1 The umpires shall be the sole judges of fair and unfair play. If either umpire considers that any action by a player, not covered by these Playing Conditions, is unfair, he/she shall call and signal Dead ball, if appropriate, as soon as it becomes clear that the call will not disadvantage the non-offending side, and report the matter to the other umpire.

- 41.2.1.1 If this is a first offence by that side, the bowler's end umpire shall then
- summon the offending player's captain and issue a first and final warning which shall apply to all members of the team for the remainder of the match.
 - warn the offending player's captain that any further such offence by any member of his team shall result in the award of 5 Penalty runs to the opposing team.
- 41.2.1.2 If this is a second or subsequent offence by that side the bowler's end umpire shall then
- summon the offending player's captain and inform him that there has been a further such offence.
 - award 5 Penalty runs to the opposing side.
- 41.2.1.3 The umpires shall may then report the matter to the ICC Match Referee who shall take such action as is considered appropriate against the player concerned.

41.3 The match ball – changing its condition

- 41.3.1 The umpires shall make frequent and irregular inspections of the ball. In addition, they shall immediately inspect the ball if they suspect anyone of attempting to change the condition of the ball, except as permitted in clause 41.3.2.
- 41.3.2 It is an offence for any player to take any action which changes the condition of the ball.
- Except in carrying out his normal duties, a batsman is not allowed to damage the ball other than, when the ball is in play, in striking it with the bat. See also clause 5.5 (Damage to the ball).
- A fielder may, however:
- 41.3.2.1 polish the ball on his clothing provided that no artificial substance is used and that such polishing wastes no time.
- 41.3.2.2 remove mud from the ball under the supervision of an umpire.
- 41.3.2.3 dry a wet ball on a piece of cloth that has been approved by the umpires.
- 41.3.3 The umpires shall consider the condition of the ball to have been unfairly changed if any action by any player does not comply with the conditions in clause 41.3.2.
- 41.3.4 If the umpires together agree that the condition of the ball has been unfairly changed by a member or members of either side, or that its condition is inconsistent with the use it has received, they shall consider that there has been a contravention of this clause and decide together whether they can identify the player(s) responsible for such conduct.

- 41.3.5 If it is possible to identify the player(s) responsible for changing the condition of the ball, the umpires shall;
- 41.3.5.1 Change the ball forthwith.
- 41.3.5.1.1 If the umpires together agree that the condition of the ball has been unfairly changed by a member or members of the fielding side, the batsman at the wicket shall choose the replacement ball from a selection of six other balls of various degrees of usage (including a new ball) and of the same brand as the ball in use prior to the contravention.
- 41.3.5.1.2 If the umpires together agree that the condition of the ball has been unfairly changed by a member or members of the batting side, the umpires shall select and bring into use immediately, a ball which shall have wear comparable to that of the previous ball immediately prior to the contravention.
- 41.3.5.2 Additionally, the bowler's end umpire shall
- award 5 Penalty runs to the opposing side.
 - if appropriate, inform the batsmen at the wicket and the captain of the fielding side that the ball has been changed and the reason for their action.
 - inform the captain of the batting side as soon as practicable of what has occurred.
- The umpires shall then report the matter to the ICC Match Referee who shall take such action as is considered appropriate against the player(s) concerned.
- 41.3.6 If it is not possible to identify the player(s) responsible for changing the condition of the ball, the umpires shall;
- 41.3.6.1 Change the ball forthwith. The umpires shall choose the replacement ball for one of similar wear and of the same brand as the ball in use prior to the contravention.
- 41.3.6.2 The bowler's end umpire shall issue the captain with a first and final warning, and
- 41.3.6.3 Advise the captain that should there be any further instances of changing the condition of the ball by that team during the remainder of the series, clause 41.3.5.2 above will be adopted, with the captain deemed to be the player responsible for the contravention.

41.4 Deliberate attempt to distract striker

- 41.4.1 It is unfair for any fielder deliberately to attempt to distract the striker while he is preparing to receive or receiving a delivery.
- 41.4.2 If either umpire considers that any action by a fielder is such an attempt, he/she shall immediately call and signal Dead ball and inform the other umpire of the reason for the call. The bowler's end umpire shall
- award 5 Penalty runs to the batting side.
 - inform the captain of the fielding side, the batsmen and, as soon as practicable, the captain of the batting side of the reason for the action.

Neither batsman shall be dismissed from that delivery and the ball shall not count as one of the over.

The umpires may then report the matter to the ICC Match Referee who shall take such action as is considered appropriate against the fielder concerned.

41.5 Deliberate distraction, deception or obstruction of batsman

- 41.5.1 In addition to clause 41.4, it is unfair for any fielder wilfully to attempt, by word or action, to distract, deceive or obstruct either batsman after the striker has received the ball.
- 41.5.2 It is for either one of the umpires to decide whether any distraction, deception or obstruction is wilful or not.
- 41.5.3 If either umpire considers that a fielder has caused or attempted to cause such a distraction, deception or obstruction, he/she shall immediately call and signal Dead ball and inform the other umpire of the reason for the call.
- 41.5.4 Neither batsman shall be dismissed from that delivery.
- 41.5.5 If an obstruction involves physical contact, the umpires together shall decide whether or not an offence under clause 42 (Players' conduct) has been committed.
- 41.5.5.1 If an offence under clause 42 (Players' conduct) has been committed, they shall apply the relevant procedures in clause 42 and shall also apply each of clauses 41.5.7 to 41.5.9.
- 41.5.5.2 If they consider that there has been no offence under clause 42 (Players' conduct), they shall apply each of clauses 41.5.6 to 41.5.10.
- 41.5.6 The bowler's end umpire shall;
- award 5 Penalty runs to the batting side.
 - inform the captain of the fielding side of the reason for this action and as soon as practicable inform the captain of the batting side.
- 41.5.7 The ball shall not count as one of the over.

- 41.5.8 Any runs completed by the batsmen before the offence shall be scored, together with any runs for penalties awarded to either side. Additionally, the run in progress shall be scored whether or not the batsmen had already crossed at the instant of the offence.
- 41.5.9 The batsmen at the wicket shall decide which of them is to face the next delivery.
- 41.5.10 The umpires may then report the matter to the ICC Match Referee who shall take such action as is considered appropriate against the fielder concerned.

41.6 Bowling of dangerous and unfair short pitched deliveries

- 41.6.1 Notwithstanding clause 41.6.2, the bowling of short pitched deliveries is dangerous if the bowler's end umpire considers that, taking into consideration the skill of the striker, by their speed, length, height and direction they are likely to inflict physical injury on him. The fact that the striker is wearing protective equipment shall be disregarded.

In the first instance the umpire decides that the bowling of short pitched deliveries has become dangerous under 41.6.1

- 41.6.1.1 The umpire shall call and signal No ball, and when the ball is dead, caution the bowler and inform the other umpire, the captain of the fielding side and the batsmen of what has occurred. This caution shall apply to that bowler throughout the innings.
- 41.6.1.2 If there is a second instance, the umpire shall repeat the above procedure and indicate to the bowler that this is a final warning, which shall apply to that bowler throughout the innings.
- 41.6.1.3 Should there be any further instance by the same bowler in that innings, the umpire shall
- call and signal No ball
 - when the ball is dead, direct the captain of the fielding side to suspend the bowler immediately from bowling
 - inform the other umpire for the reason for this action.
- The bowler thus suspended shall not be allowed to bowl again in that innings.
- If applicable, the over shall be completed by another bowler, who shall neither have bowled any part of the previous over, nor be allowed to bowl any part of the next over.
- The umpire shall report the occurrence to the batsmen and, as soon as practicable, to the captain of the batting side.

The umpires may then report the matter to the ICC Match Referee who shall take such action as is considered appropriate against the bowler concerned.

- 41.6.14 A bowler shall be limited to one fast short-pitched delivery per over.
- 41.6.15 A fast short-pitched delivery is defined as a ball, which passes or would have passed above the shoulder height of the striker standing upright at the popping crease.
- 41.6.16 The umpire at the bowler's end shall advise the bowler and the batsman on strike when each fast short pitched delivery has been bowled.
- 41.6.17 In addition, a ball that passes above head height of the batsman, standing upright at the popping crease, that prevents him from being able to hit it with his bat by means of a normal cricket stroke shall be called a Wide. See also clause 22.1.1.2
- 41.6.17.1 For the avoidance of doubt any fast short pitched delivery that is called a Wide under this clause shall also count as one of the allowable short pitched deliveries in that over.
- 41.6.18 In the event of a bowler bowling more than one fast short-pitched delivery in an over as defined in clause 41.6.1.5 above, the umpire at the bowler's end shall call and signal No ball on each occasion. A differential signal shall be used to signify a fast short pitched delivery. The umpire shall call and signal 'No ball' and then tap the head with the other hand.
- 41.6.19 If a bowler delivers a second fast short pitched ball in an over, the umpire, after the call of No ball and when the ball is dead, shall caution the bowler, inform the other umpire, the captain of the fielding side and the batsmen at the wicket of what has occurred. This caution shall apply throughout the innings.
- 41.6.110 If there is a second instance of the bowler being No balled in the innings for bowling more than one fast short pitched delivery in an over, the umpire shall advise the bowler that this is his final warning for the innings.
- 41.6.111 Should there be any further instance by the same bowler in that innings, the umpire shall
- call and signal No ball
 - when the ball is dead, direct the captain of the fielding side to suspend the bowler immediately from bowling
 - inform the other umpire for the reason for this action.
- The bowler thus suspended shall not be allowed to bowl again in that innings.

If applicable, the over shall be completed by another bowler, who shall neither have bowled any part of the previous over, nor be allowed to bowl any part of the next over.

- The umpire shall report the occurrence to the batsmen and, as soon as practicable, to the captain of the batting side.

The umpires may then report the matter to the ICC Match Referee who shall take such action as is considered appropriate against the bowler concerned.

- 41.6.2 Should the umpires initiate the caution and warning procedures set out in clauses 41.6.1.3, 41.6.1.9 and 41.7, such cautions and warnings are not to be cumulative.

41.7 Bowling of dangerous and unfair non-pitching deliveries

- 41.7.1 Any delivery, which passes or would have passed, without pitching, above waist height of the striker standing upright at the popping crease, is to be deemed to be unfair, whether or not it is likely to inflict physical injury on the striker. If the bowler bowls such a delivery the umpire shall immediately call and signal No ball.

If, in the opinion of the umpire, such a delivery is considered likely to inflict physical injury on the batsman by its speed and direction, it shall be considered dangerous. When the ball is dead the umpire shall caution the bowler, indicating that this is a first and final warning. The umpire shall also inform the other umpire, the captain of the fielding side and the batsmen of what has occurred. This caution shall apply to that bowler throughout the innings.

- 41.7.2 Should there be any further instance (where a dangerous non-pitching delivery is bowled and is considered likely to inflict physical injury on the batsman) by the same bowler in that innings, the umpire shall

- call and signal No ball
- when the ball is dead, direct the captain of the fielding side to suspend the bowler immediately from bowling
- inform the other umpire for the reason for this action.

The bowler thus suspended shall not be allowed to bowl again in that innings.

If applicable, the over shall be completed by another bowler, who shall neither have bowled any part of the previous over, nor be allowed to bowl any part of the next over.

Additionally the umpire shall

- report the occurrence to the batsmen and, as soon as practicable, to the captain of the batting side.

The umpires may then report the matter to the ICC Match Referee who shall take such action as is considered appropriate against the bowler concerned.

- 41.7.3 The warning sequence in clauses 41.7.1 and 41.7.2 is independent of the warning and action sequence in clause 41.6.
- 41.7.4 If the umpire considers that a bowler deliberately bowled a high full-pitched delivery, deemed to be dangerous and unfair as defined in clause 41.7.1, then the caution and warning in clause 41.7.1 shall be dispensed with. The umpire shall
- immediately call and signal No ball.
 - when the ball is dead, direct the captain of the fielding side to suspend the bowler immediately from bowling and inform the other umpire for the reason for this action.
- The bowler thus suspended shall not be allowed to bowl again in that innings.
- If applicable, the over shall be completed by another bowler, who shall neither have bowled any part of the previous over, nor be allowed to bowl any part of the next over.
- report the occurrence to the batsmen and, as soon as practicable, to the captain of the batting side.
- The umpires together shall report the occurrence to the ICC Match Referee who shall take such action as is considered appropriate against the bowler concerned.

41.8 Bowling of deliberate front-foot No ball

If the umpire considers that the bowler has delivered a deliberate front-foot No ball, he/she shall

- immediately call and signal No ball.
- when the ball is dead, direct the captain of the fielding side to suspend the bowler immediately from bowling.
- inform the other umpire for the reason for this action.

The bowler thus suspended shall not be allowed to bowl again in that innings.

If applicable, the over shall be completed by another bowler, who shall neither have bowled any part of the previous over, nor be allowed to bowl any part of the next over.

- report the occurrence to the batsmen and, as soon as practicable, to the captain of the batting side.

The umpires together shall report the occurrence to the ICC Match Referee who shall take such action as is considered appropriate against the bowler concerned.

41.9 Time wasting by the fielding side

- 41.9.1 It is unfair for any fielder to waste time.
- 41.9.2 If either umpire considers that the progress of an over is unnecessarily slow, or time is being wasted in any other way, by the captain of the fielding side or by any other fielder, at the first instance the umpire concerned shall
- if the ball is in play, call and signal Dead ball.
 - inform the other umpire of what has occurred.

The bowler's end umpire shall then

- warn the captain of the fielding side, indicating that this is a first and final warning.
- inform the batsmen of what has occurred.

- 41.9.3 If either umpire considers that there is any further waste of time in that innings by any fielder, the umpire concerned shall
- if the ball is in play, call and signal Dead ball.
 - inform the other umpire of what has occurred.

The bowler's end umpire shall then award 5 Penalty runs to the batting side and inform the captain of the fielding side of the reason for this action.

Additionally the umpire shall inform the batsmen and, as soon as is practicable, the captain of the batting side of what has occurred.

If the umpires believe that the act of time wasting was deliberate or repetitive, they may lodge a report under the ICC Code of Conduct. In such circumstances the Captain and/or any individual members of the fielding team responsible for the time wasting will be charged.

41.10 Batsman wasting time

- 41.10.1 It is unfair for a batsman to waste time. In normal circumstances, the striker should always be ready to take strike when the bowler is ready to start his run-up.
- 41.10.2 Should either batsman waste time by failing to meet this requirement, or in any other way, the following procedure shall be adopted. At the first instance, either before the bowler starts his run-up or when the ball becomes dead, as appropriate, the umpire shall
- warn both batsmen and indicate that this is a first and final warning. This warning shall apply throughout the innings. The umpire shall so inform each incoming batsman.
 - inform the other umpire of what has occurred.
 - inform the captain of the fielding side and, as soon as practicable, the captain of the batting side of what has occurred.
- 41.10.3 If there is any further time wasting by any batsman in that innings, the umpire shall, at the appropriate time while the ball is dead
- award 5 Penalty runs to the fielding side.
 - inform the other umpire of the reason for this action.
 - inform the other batsman, the captain of the fielding side and, as soon as practicable, the captain of the batting side of what has occurred.

If the umpires believe that the act of time wasting was deemed to be deliberate or repetitive, they may lodge a report under the ICC Code of Conduct. In such circumstances the batsman concerned will be charged.

41.11 The protected area

The protected area is defined as that area of the pitch contained within a rectangle bounded at each end by imaginary lines parallel to the popping creases and 5 ft/1.52 m in front of each, and on the sides by imaginary lines, one each side of the imaginary line joining the centres of the two middle stumps, each parallel to it and 1 ft/30.48 cm from it.

41.12 Fielder damaging the pitch

41.12.1 It is unfair to cause deliberate or avoidable damage to the pitch. A fielder will be deemed to be causing avoidable damage if either umpire considers that his presence on the pitch is without reasonable cause.

41.12.2 If a fielder causes avoidable damage to the pitch, other than as in clause 41.13.1, at the first instance the umpire seeing the contravention shall, when the ball is dead, inform the other umpire. The bowler's end umpire shall then

- caution the captain of the fielding side and indicate that this is a first and final warning. This warning shall apply throughout the innings.
- inform the batsmen of what has occurred.

41.12.3 If, in that innings, there is any further instance of avoidable damage to the pitch, by any fielder, the umpire seeing the contravention shall, when the ball is dead, inform the other umpire. The bowler's end umpire shall then:

- award 5 Penalty runs to the batting side.

Additionally the umpire shall:

- inform the fielding captain of the reason for this action.
- inform the batsmen and, as soon as practicable, the captain of the batting side of what has occurred.

The umpires together shall report the occurrence to the ICC Match Referee who shall take such action as is considered appropriate against the fielder concerned.

41.13 Bowler running on protected area

41.13.1 It is unfair for a bowler to enter the protected area in his follow-through without reasonable cause, whether or not the ball is delivered.

41.13.2 If a bowler contravenes this clause, at the first instance and when the ball is dead, the umpire shall

- caution the bowler and inform the other umpire of what has occurred. This caution shall apply to that bowler throughout the innings.
- inform the captain of the fielding side and the batsmen of what has occurred.

41.13.3 If, in that innings, the same bowler again contravenes this clause, the umpire shall repeat the above procedure indicating that this is a final warning. This warning shall also apply throughout the innings.

41.13.4 If, in that innings, the same bowler contravenes this clause a third time, when the ball is dead, the umpire shall,

- direct the captain of the fielding side to suspend the bowler immediately from bowling. If applicable, the over shall be completed by another bowler, who shall neither have bowled any part of the previous over, nor be allowed to bowl any part of the next over. The bowler taken off shall not be allowed to bowl again in that innings.
- inform the other umpire of the reason for this action.
- inform the batsmen and, as soon as practicable, the captain of the batting side of what has occurred.

The umpires may then report the matter to the ICC Match Referee who shall take such action as is considered appropriate against the bowler concerned.

41.14 Batsman damaging the pitch

41.14.1 It is unfair to cause deliberate or avoidable damage to the pitch. If the striker enters the protected area in playing or playing at the ball, he must move from it immediately thereafter. A batsman will be deemed to be causing avoidable damage if either umpire considers that his presence on the pitch is without reasonable cause.

41.14.2 If either batsman causes deliberate or avoidable damage to the pitch, other than as in clause 41.15, at the first instance the umpire seeing the contravention shall, when the ball is dead, inform the other umpire of the occurrence. The bowler's end umpire shall then

- warn both batsmen that the practice is unfair and indicate that this is a first and final warning. This warning shall apply throughout the innings. The umpire shall so inform each incoming batsman.
- inform the captain of the fielding side and, as soon as practicable, the captain of the batting side of what has occurred.

41.14.3 If there is any further instance of avoidable damage to the pitch by any batsman in that innings, the umpire seeing the contravention shall, when the ball is dead, inform the other umpire of the occurrence.

The bowler's end umpire shall

- disallow all runs to the batting side.
- return any not out batsman to his original end.
- signal No ball or Wide to the scorers if applicable.
- award 5 Penalty runs to the fielding side.

- award any other 5-run Penalty that is applicable except for Penalty runs under clause 28.3 (Protective helmets belonging to the fielding side).
- Inform the captain of the fielding side and, as soon as practicable, the captain of the batting side of the reason for this action.

The umpires together shall report the occurrence to the ICC Match Referee who shall take such action as is considered appropriate against the batsman concerned.

41.15 Striker in protected area

- 41.15.1 The striker shall not adopt a stance in the protected area or so close to it that frequent encroachment is inevitable.

The striker may mark a guard on the pitch provided that no mark is unreasonably close to the protected area.

- 41.15.2 If either umpire considers that the striker is in breach of any of the conditions in clause 41.15.1, if the bowler has not entered the delivery stride, he/she shall immediately call Dead ball, otherwise, wait until the ball is dead; he/she shall then inform the other umpire of the occurrence.

The bowler's end umpire shall then

- warn the striker that the practice is unfair and indicate that this is a first and final warning. This warning shall apply throughout the innings. The umpire shall so inform the non-striker and each incoming batsman.
- inform the captain of the fielding side and, as soon as practicable, the captain of the batting side of what has occurred.

- 41.15.3 If there is any further breach of any of the conditions in clause 41.15.1 by any batsman in that innings, the umpire seeing the contravention shall, if the bowler has not entered his delivery stride, immediately call and signal Dead ball, otherwise, he/she shall wait until the ball is dead and then inform the other umpire of the occurrence.

The bowler's end umpire shall

- disallow all runs to the batting side.
- return any not out batsman to his original end.
- signal No ball or Wide to the scorers if applicable.
- award 5 Penalty runs to the fielding side.
- award any other 5-run Penalty that is applicable except for Penalty runs under clause 28.3 (Protective helmets belonging to the fielding side).
- inform the captain of the fielding side and, as soon as practicable, the captain of the batting side of the reason for this action.

The umpires together shall report the occurrence to the ICC Match Referee who shall take such action as is considered appropriate against the batsman concerned.

41.16 Non-striker leaving his ground early

If the non-striker is out of his ground from the moment the ball comes into play to the instant when the bowler would normally have been expected to release the ball, the bowler is permitted to attempt to run him out. Whether the attempt is successful or not, the ball shall not count as one in the over.

If the bowler fails in an attempt to run out the non-striker, the umpire shall call and signal Dead ball as soon as possible.

41.17 Batsmen stealing a run

- 41.17.1 It is unfair for the batsmen to attempt to steal a run during the bowler's run-up.

Unless the bowler attempts to run out either batsman – see clauses 41.16 and 21.4 (Bowler throwing towards striker's end before delivery) – the umpire shall

- call and signal Dead ball as soon as the batsmen cross in such an attempt.
- inform the other umpire of the reason for this action.

The bowler's end umpire shall then

- return the batsmen to their original ends.
- award 5 Penalty runs to the fielding side.
- inform the batsmen, the captain of the fielding side and, as soon as practicable, the captain of the batting side, of the reason for this action.

The umpires may then report the matter to the ICC Match Referee who shall take such action as is considered appropriate against the batsman concerned.

41.18 Penalty runs

- 41.18.1 When Penalty runs are awarded to either side, when the ball is dead the umpire shall signal the Penalty runs to the scorers. See clause 2.13 (Signals).

- 41.18.2 Penalty runs shall be awarded in each case where these Playing Conditions require the award, even if a result has already been achieved. See clause 16.6 (Winning hit or extras).

Note, however, that the restrictions on awarding Penalty runs, in clauses 23.3 (Leg byes not to be awarded), 34.4 (Runs scored from ball lawfully struck more than once) and 28.3 (Protective helmets belonging to the fielding side), will apply.

- 41.18.3 When 5 Penalty runs are awarded to the batting side under any of clauses 24.4 (Player returning without permission), 28.2 (Fielding the ball), or 28.3 (Protective helmets belonging to the fielding side) or under 41.3, 41.4, 41.5, 41.9 or 41.12, then
- they shall be scored as Penalty extras and shall be in addition to any other penalties.

- they are awarded when the ball is dead and shall not be regarded as runs scored from either the immediately preceding delivery or the immediately following delivery, and shall be in addition to any runs from those deliveries.
- the batsmen shall not change ends solely by reason of the 5 run penalty.

41.18.4 When 5 Penalty runs are awarded to the fielding side, under clause 18.5.2 (Deliberate short runs), or under 41.10, 41.14, 41.15 or 41.17, they shall be added as Penalty extras to that side's total of runs in its most recently completed innings. If the fielding side has not completed an innings, the 5 Penalty runs shall be added to the score in its next innings.

42 PLAYERS' CONDUCT

42.1 Serious misconduct

- 42.1.1 The umpires shall act upon any serious misconduct. The relevant offences and the corresponding actions by the umpires are identified in clause 42.2.1. These offences correspond with Level 4 offences in the ICC Code of Conduct. Level 1 to Level 3 offences continue to be dealt with separately under the ICC Code of Conduct.
- 42.1.2 If either umpire considers that a player has committed one of these offences at any time during the match, the umpire concerned shall call and signal Dead ball. This call may be delayed until the umpire is satisfied that it will not disadvantage the non-offending side.
- 42.1.3 The umpire concerned shall report the matter to the other umpire and together they shall decide whether an offence has been committed. The umpires may also consult with the third umpire and the match referee, who may review any audio or video replays to confirm whether an offence has been committed. If so, the umpires shall then apply the related sanctions.
- 42.1.4 If the offence is committed by a batsman, the umpires shall summon the offending player's captain to the field. Solely for the purpose of this clause, the batsmen at the wicket may not deputise for their captain.

42.2 Level 4 offences and action by umpires

- 42.2.1 Any of the following actions by a player shall constitute a Level 4 offence:
- threatening to assault an umpire
 - making inappropriate and deliberate physical contact with an umpire
 - physically assaulting a player or any other person
 - committing any other act of violence.

42.2.2 If such an offence is committed, 42.2.2.1 to 42.2.2.5 shall be implemented.

42.2.2.1 The umpire shall call Time.

42.2.2.2 Together the umpires shall summon and inform the offending player's captain that an offence at this Level has occurred.

42.2.2.3 The umpires shall instruct the captain to remove the offending player immediately from the field of play for the remainder of the match and shall apply the following:

42.2.2.3.1 If the offending player is a fielder, no substitute shall be allowed for him. He is to be recorded as Retired – out at the commencement of any subsequent innings in which his team is the batting side.

42.2.2.3.2 If a bowler is suspended mid-over, then that over must be completed by a different bowler, who shall not have bowled the previous over nor shall be permitted to bowl the next over.

42.2.2.3.3 If the offending player is a batsman he is to be recorded as Retired – out in the current innings, unless he has been dismissed under any of clauses 32 to 39, and at the commencement of any subsequent innings in which his team is the batting side. If no further batsman is available to bat, the innings is completed.

42.2.2.4 As soon as practicable, the umpire shall:

- award 5 Penalty runs to the opposing team
- signal the Level 4 penalty to the scorers
- call Play.

42.2.2.5 The umpires shall then report the matter to the ICC Match Referee under the ICC Code of Conduct.

42.3 Captain refusing to remove a player from the field

42.3.1 If a captain refuses to carry out an instruction under 42.2.2.3, the umpires shall invoke clause 16.2 (ICC Match Referee awarding a match).

42.3.2 If both captains refuse to carry out instructions under 42.2.2.3 in respect of the same incident, the umpires shall instruct the players to leave the field. The match is not concluded as in clause 16.2 and there shall be no result under clause 16.

42.4 Additional points relating to Level 4 offences

- 42.4.1 If a player, while acting as wicket-keeper, commits a Level 4 offence, clause 24.1.2 shall not apply, meaning that only a nominated player may keep wicket, even if another fielder becomes injured or ill and is replaced by a substitute.
- 42.4.2 A nominated player who has a substitute will also suffer the penalty for any Level 4 offence committed by the substitute. However, only the substitute will be reported under clause 42.2.2.5.

APPENDICES TO ICC TWENTY20 INTERNATIONAL PLAYING CONDITIONS

(INCORPORATING THE 2017 CODE OF THE MCC LAWS OF CRICKET)

A. Definitions**B. Equipment**

1. The bat
2. The wickets
3. Wicket-keeping gloves

C. The venue

1. The pitch and the creases
2. Advertising on grounds, perimeter boards and sight-screens
3. Markings on outfield

D. Decision Review System (DRS) and Third Umpire Protocol**E. Calculations****F. The Super Over**

APPENDIX A

DEFINITIONS

1 THE MATCH

- 1.1 **The game** is used in these Playing Conditions as a general term meaning the Game of Cricket.
- 1.2 **A match** is a single Twenty20 International match between two teams, played under these Playing Conditions.
- 1.3 **T20I** is an abbreviation for Twenty20 International.
- 1.4 **A Super Over** is a procedure that may be adopted for determining the result of a tied match, as set out in Appendix F.
- 1.5 **The toss** is the toss for choice of innings.
- 1.6 **Before the toss** is at any time before the toss on the day of the match.
- 1.7 **Before the match** is at any time before the toss, not restricted to the day of the match.
- 1.8 **During the match** is at any time after the toss until the conclusion of the match, whether play is in progress or not.
- 1.9 **Playing time** is any time between the call of Play and the call of Time. See clauses 12.1 (Call of Play) and 12.2 (Call of Time).
- 1.10 **Conduct of the match** includes any action relevant to the match at any time.
- 1.11 **Ground Authority** is the entity responsible for the selection and preparation of the pitch and other functions relating to the hosting and management of the match, including any agents acting on their behalf (including but not limited to the curator or other ground staff).
- 1.12 **Home Board** is the ICC member responsible for the home team and the hosting of the match.
- 1.13 **Visiting Board** is the ICC member responsible for the visiting team.
- 1.14 **The Spirit of Cricket** refers to the values of respect and fair play that underpin the game of cricket, as set out in the Preamble to these Playing Conditions.
- 1.15 **The ICC Code of Conduct** is the ICC Code of Conduct for Players and Player Support Personnel, as amended from time to time.

2 IMPLEMENTS AND EQUIPMENT

- 2.1 **Implements used in the match** are the bat, the ball, the stumps and balls.
- 2.2 **External protective equipment** is any visible item of apparel worn for protection against external blows.

For a batsman, items permitted are a protective helmet, external leg guards (batting pads), batting gloves and, if visible, forearm guards.

For a fielder, only a protective helmet is permitted, except in the case of a wicket-keeper, for whom wicket-keeping pads and gloves are also permitted.

- 2.3 **A protective helmet** is headwear made of hard material and designed to protect the head or the face or both, which shall (in line with the Clothing and Equipment Regulations) be certified to BS7928:2013. For the purposes of interpreting these Playing Conditions, such a description will include faceguards.
- 2.4 **Equipment** – a batsman's equipment is his/her bat as defined above, together with any external protective equipment he is wearing.
A fielder's equipment is any external protective equipment that he is wearing.
- 2.5 **The bat** – the following are to be considered as part of the bat:
 - the whole of the bat itself.
 - the whole of a glove (or gloves) worn on the hand (or hands) holding the bat.
 - the hand (or hands) holding the bat, if the batsman is not wearing a glove on that hand or on those hands.
- 2.6 **Held in batsman's hand.** Contact between a batsman's hand, or glove worn on his/her hand, and any part of the bat shall constitute the bat being held in that hand.

3 THE PLAYING AREA

- 3.1 **The field of play** is the area contained within the boundary.
- 3.2 **The square** is a specially prepared area of the field of play within which the match pitch is situated.
- 3.3 **The outfield** is that part of the field of play between the square and the boundary.

4 POSITIONING

- 4.1 **Behind the popping crease** at one end of the pitch is that area of the field of play, including any other marking, objects and persons therein, that is on that side of the popping crease that does not include the creases at the opposite end of the pitch. **Behind**, in relation to any other marking, object or person, follows the same principle. See the diagram in paragraph 13.
- 4.2 **In front of the popping crease** at one end of the pitch is that area of the field of play, including any other marking, objects and persons therein, that is on that side of the popping crease that includes the creases at the opposite end of the pitch. In front of, in relation to any other marking, object or person, follows the same principle. See the diagram in paragraph 13.
- 4.3 **The striker's end** is the place where the striker stands to receive a delivery from the bowler only insofar as it identifies, independently of where the striker may subsequently move, one end of the pitch.
- 4.4 **The bowler's end** is the end from which the bowler delivers the ball. It is the other end of the pitch from the striker's end and identifies that end of the pitch that is not the striker's end as described in paragraph 4.3.
- 4.5 **The wicket-keeper's end** is the same as the striker's end as described in paragraph 4.3.

- 4.6 In front of the line of the striker's wicket** is in the area of the field of play in front of the imaginary line joining the fronts of the stumps at the striker's end; this line to be considered extended in both directions to the boundary. See paragraph 4.2.
- 4.7 Behind the wicket** is in the area of the field of play behind the imaginary line joining the backs of the stumps at the appropriate end; this line to be considered extended in both directions to the boundary. See paragraph 4.1.
- 4.8 Behind the wicket-keeper** is behind the wicket at the striker's end, as defined above, but in line with both sets of stumps and further from the stumps than the wicket-keeper.
- 4.9 Off side/on (leg) side** – see diagram in paragraph 13.
- 4.10 Inside edge** is the edge on the same side as the nearer wicket.

5 UMPIRES AND DECISION-MAKING

- 5.1 Umpire** – where the description **the umpire** is used on its own, it always means 'the bowler's end umpire' though this full description is sometimes used for emphasis or clarity. Similarly **the umpires** always means both umpires and the third umpire. **An umpire** and **umpires** are generalised terms. Otherwise, a fuller description indicates which one of the umpires is specifically intended. Each umpire will be bowler's end umpire and striker's end umpire in alternate overs.
- 5.2 Bowler's end umpire** is the umpire who is standing at the bowler's end (see paragraph 4.4) for the current delivery.
- 5.3 Striker's end umpire** is the umpire who is standing at the striker's end (see paragraph 4.3), to one side of the pitch or the other, depending on his/her choice, for the current delivery.
- 5.4 On-field umpires** shall mean, collectively, the bowler's end umpire and the striker's end umpire.
- 5.5 Third umpire** is the umpire who may use television evidence and other available technology in order review a decision of the on-field umpires, either by way of an Umpire Review or a Player Review under the protocol set out in Appendix D.
- 5.6 Umpires together agree** applies to decisions which the umpires are to make jointly, independently of the players.
- 5.7 Decision Review System** or **DRS** is the process covered by the Decision Review System and Third Umpire Protocol set out in Appendix D, under which the third umpire may be consulted in relation to a decision of the on-field umpires, either by way of an Umpire Review or a Player Review.
- 5.8 Player Review** is the process set out in Appendix D by which a player may request a review of any decision taken by the on-field umpires concerning whether or not a batsman is dismissed (with the exception of Timed out).
- 5.9 Umpire Review** is the process set out in Appendix D by which an on-field umpire has the discretion to refer a decision to the third umpire or, under certain circumstances, to consult with the third umpire before making a decision.

- 5.10 Soft Signal** is the visual communication by the bowler's end umpire to the third umpire (accompanied by additional information via two-way radio where necessary) of his/her initial on-field decision prior to initiating an Umpire Review.
- 5.11 Umpire's Call** is the concept within the DRS under which the on-field decision of the bowler's end umpire shall stand, which shall apply under the specific circumstances set out in paragraphs 3.4.5 and 3.4.6 of Appendix D, where the ball-tracking technology indicates a marginal decision in respect of either the Impact Zone or the Wicket Zone.
- 5.12 The Pitching Zone** as used in the DRS is a two dimensional area on the pitch between both sets of stumps with its boundaries consisting of the base of both sets of stumps and a line between the outside of the outer stumps at each end.
- 5.13 The Impact Zone** as used in the DRS is a three dimensional space extending between both sets of stumps to an indefinite height vertically and with its boundaries consisting of the base of the stumps and the outside of the outer stumps at each end.
- 5.14 The Wicket Zone** as used in the DRS is a two dimensional area with its boundaries consisting of the outside of the outer stumps, the base of the stumps, and the lower edge of the bails.
- 5.15 A Fair Catch** is a catch that has been taken cleanly by the fielder in accordance with clause 33.
- 5.16 A Bump Ball** is where the ball has made contact with the ground shortly after making contact with the striker's bat.
- 5.17 The Elite Panel** is the group of umpires contracted to the ICC to officiate in international cricket.
- 5.18 The International Panel** is the group of umpires nominated by the ICC's full members in accordance with clause 2.1.3 of the Playing Conditions.

6 BATSMEN

- 6.1 Batting side** is the side currently batting, whether or not play is in progress.
- 6.2 Member of the batting side** is one of the players nominated by the captain of the batting side, or any authorised replacement for such nominated player.
- 6.3 A batsman's ground** – at each end of the pitch, the whole area of the field of play behind the popping crease is the ground at that end for a batsman.
- 6.4 Original end** is the end where a batsman was when the ball came into play for that delivery.
- 6.5 Wicket he has left** is the wicket at the end where a batsman was at the start of the run in progress.
- 6.6 Guard position** is the position and posture adopted by the striker to receive a ball delivered by the bowler.
- 6.7** For the purposes of these Playing Conditions, waist height is defined as the point at which the top of the batsman's trousers would conventionally be when he is standing upright at the popping crease.

7 FIELDERS

- 7.1 Fielding side** is the side currently fielding, whether or not play is in progress.
- 7.2 Member of the fielding side** is one of the players nominated by the captain of the fielding side, or any authorised replacement or substitute for such nominated player.
- 7.3 Fielder** is one of the 11 or fewer players who together represent the fielding side on the field of play. This definition includes not only both the bowler and the wicket-keeper but also nominated players who are legitimately on the field of play, together with players legitimately acting as substitutes for absent nominated players. It excludes any nominated player who is absent from the field of play, or who has been absent from the field of play and who has not yet obtained the umpire's permission to return.

A player going briefly outside the boundary in the course of discharging his/her duties as a fielder is not absent from the field of play nor, for the purposes of clause 24.2 (Fielder absent or leaving the field of play), is he to be regarded as having left the field of play.

8 SUBSTITUTES AND CONCUSSION REPLACEMENTS

- 8.1 A Substitute** is a player who takes the place of a fielder on the field of play, but does not replace the player for whom he substitutes on that side's list of nominated players. A substitute's activities are limited to fielding.
- 8.2 A Concussion Replacement** is a player who takes the place of a player who has been replaced in accordance with the process set out in clause 12.7, and who for the remainder of the match replaces that player on that side's list of nominated players, being able to take a full part in the match (subject to such restrictions as may be imposed by the ICC Match Referee in accordance with clause 12.8).
- 8.3 A Concussion Replacement Request** is the notification made to the ICC Match Referee in accordance with the process set out in clause 12.7.3.
- 8.4 The Team Medical Representative** is the individual designated as having responsibility for the assessment of any head or neck injury sustained by a player as set out in clause 12.7.2.

9 BOWLERS

- 9.1 Over the wicket/round the wicket** – If, as the bowler runs up between the wicket and the return crease, the wicket is on the same side as his bowling arm, he is bowling over the wicket. If the return crease is on the same side as his bowling arm, he is bowling round the wicket.
- 9.2 Delivery swing** is the motion of the bowler's arm during which he normally releases the ball for a delivery.
- 9.3 Delivery stride** is the stride during which the delivery swing is made, whether the ball is released or not. It starts when the bowler's back foot lands for that stride and ends when the front foot lands in the same stride. The stride after the delivery stride is completed when the next foot lands, i.e. when the back foot of the delivery stride lands again.

- 9.4 The Illegal Bowling Regulations** are the ICC's regulations governing Illegal Bowling Actions.
- 9.5 An Illegal Bowling Action** is a bowling action where a bowler's Elbow Extension exceeds 15 degrees, measured from the point at which the bowling arm reaches the horizontal until the point at which the ball is released (any Elbow Hyperextension shall be discounted for the purposes of determining an Illegal Bowling Action).
- 9.6 Elbow Extension** means the motion that occurs when a bowler's arm moves from a flexed (bent) position at the elbow, to a more extended (straight) position (full Elbow Extension occurs when the arm is straight).
- 9.7 Elbow Hyperextension** is the motion that occurs when a bowler's elbow extends beyond the straight position.
- 9.8 The ICC Bowling Action Report Form** is the form provided for by Article 3 of the Illegal Bowling Regulations, by which an umpire and/or the ICC Match Referee may submit a report relating to a suspected Illegal Bowling Action.

10 THE BALL

- 10.1 The ball is struck/strikes the ball** unless specifically defined otherwise, mean 'the ball is struck by the bat'/'strikes the ball with the bat'.
- 10.2 Rebounds directly/strikes directly** and similar phrases mean 'without contact with any fielder' but do not exclude contact with the ground.
- 10.3 Full-pitch** describes a ball delivered by the bowler that reaches or passes the striker without having touched the ground. Sometimes described as non-pitching.

11 RUNS

- 11.1 A run to be disallowed** is one that in these Playing Conditions should not have been taken. It is not only to be cancelled but the batsmen are to be returned to their original ends.
- 11.2 A run not to be scored** is one that is not illegal, but is not recognised as a properly executed run. It is not a run that has been made, so the question of cancellation does not arise. The loss of the run so attempted is not a disallowance and the batsmen will not be returned to their original ends on that account.

12 THE PERSON

- 12.1 Person:** A player's person is his/her physical person (flesh and blood) together with any clothing or legitimate external protective equipment that he is wearing except, in the case of a batsman, his/her bat.

A hand, whether gloved or not, that is not holding the bat is part of the batsman's person.

No item of clothing or equipment is part of the player's person unless it is attached to him.

For a batsman, a glove being held but not worn is part of his/her person.

For a fielder, an item of clothing or equipment he is holding in his/her hand or hands is not part of his person.

- 12.2 **Clothing** – anything that a player is wearing, including such items as spectacles or jewellery, that is not classed as external protective equipment is classed as clothing, even though he may be wearing some items of apparel, which are not visible, for protection. A bat being carried by a batsman does not come within this definition of clothing.
- 12.3 **Hand** for batsman or wicket-keeper shall include both the hand itself and the whole of a glove worn on the hand.

13 OFF SIDE/ON SIDE; IN FRONT OF/ BEHIND THE POPPING CREASE

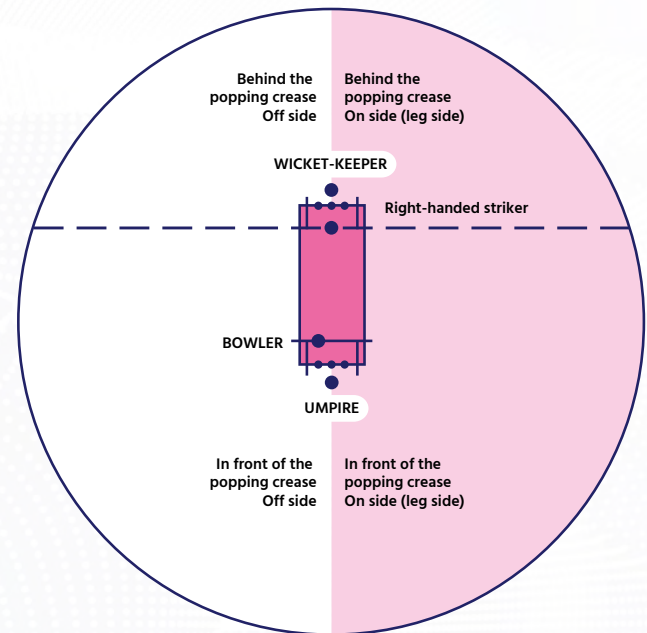

APPENDIX B

EQUIPMENT

1 THE BAT

1.1 General guidance

- 1.1.1 **Measurements** – All provisions in paragraphs 1.2 to 1.6 below are subject to the measurements and restrictions stated in the Playing Conditions and this Appendix.
- 1.1.2 **Adhesives** – Throughout, adhesives are permitted only where essential and only in minimal quantity.

1.2 Specifications for the Handle

- 1.2.1 One end of the handle is inserted into a recess in the blade as a means of joining the handle and the blade.
- This lower portion is used purely for joining the blade and the handle together. It is not part of the blade but, solely in interpreting paragraphs 1.3 and 1.4 below, references to the blade shall be considered to extend also to this lower portion of the handle where relevant.
- 1.2.2 The handle may be glued where necessary and bound with twine along the upper portion.
- Providing clause 5.5 is not contravened, the upper portion may be covered with materials solely to provide a surface suitable for gripping. Such covering is an addition and is not part of the bat, except in relation to clause 5.6. The bottom of this grip should not extend below the point defined in paragraph 1.2.4 below.
- Twine binding and the covering grip may extend beyond the junction of the upper and lower portions of the handle, to cover part of the shoulders of the bat as defined in paragraph 1.3.1.
- No material may be placed on or inserted into the lower portion of the handle other than as permitted above together with the minimal adhesives or adhesive tape used solely for fixing these items, or for fixing the handle to the blade.
- 1.2.3 **Materials in handle** – As a proportion of the total volume of the handle, materials other than cane, wood or twine are restricted to one-tenth. Such materials must not project more than 3.25 in/8.26 cm into the lower portion of the handle.
- 1.2.4 **Binding and covering of handle** – The permitted continuation beyond the junction of the upper and lower portions of the handle is restricted to a maximum, measured along the length of the handle, of
- 2.5 in/6.35 cm in for the twine binding.
 - 2.75 in/6.99 cm for the covering grip.

1.3 Specifications for the Blade

- 1.3.1 The blade has a face, a back, a toe, sides and shoulders
- 1.3.1.1 The face of the blade is its main striking surface and shall be flat or have a slight convex curve resulting from traditional pressing techniques. The back is the opposite surface.
- 1.3.1.2 The shoulders, sides and toe are the remaining surfaces, separating the face and the back.
- 1.3.1.3 The shoulders, one on each side of the handle, are along that portion of the blade between the first entry point of the handle and the point at which the blade first reaches its full width.
- 1.3.1.4 The toe is the surface opposite to the shoulders taken as a pair.
- 1.3.1.5 The sides, one each side of the blade, are along the rest of the blade, between the toe and the shoulders.
- 1.3.2 No material may be placed on or inserted into the blade other than as permitted in paragraph 1.2.4, paragraph 1.3.3, and clause 5.4 together with the minimal adhesives or adhesive tape used solely for fixing these items, or for fixing the handle to the blade.
- 1.3.3 **Covering the blade.** Bats shall have no covering on the blade except as permitted in clause 5.4.
- Any materials referred to above, in clause 5.4 and paragraph 1.4 below, are to be considered as part of the bat, which must still pass through the gauge as defined in paragraph 1.6.

1.4 Protection and repair

- 1.4.1 The surface of the blade may be treated with non-solid materials to improve resistance to moisture penetration and/or mask natural blemishes in the appearance of the wood. Save for the purpose of giving a homogeneous appearance by masking natural blemishes, such treatment shall not materially alter the colour of the blade.
- 1.4.2 Materials can be used for protection and repair as stated in clause 5.4 and are additional to the blade. Note however clause 5.6.
- Any such material shall not extend over any part of the back of the blade except in the case of clause 5.4.1 and then only when it is applied as a continuous wrapping covering the damaged area.
- The repair material shall not extend along the length of the blade more than 0.79 in/2.0 cm in each direction beyond the limits of the damaged area. Where used as a continuous binding, any overlapping shall not breach the maximum of 0.04 in/0.1 cm in total thickness.
- The use of non-solid material which when dry forms a hard layer more than 0.004 in/0.01 cm in thickness is not permitted.
- 1.4.3 Permitted coverings, repair material and toe guards, not exceeding their specified thicknesses, may be additional to the dimensions above, but the bat must still pass through the gauge as described in paragraph 1.6.

1.5 Commercial identifications

Such identifications shall comply with the restrictions set out in the Clothing and Equipment Regulations in relation to the size and position of marks and logos.

1.6 Bat Gauge

All bats must meet the specifications defined in clause 5.7. They must also, with or without protective coverings permitted in clause 5.4, be able to pass through a bat gauge, the dimensions and shape of which are shown in the following diagram:

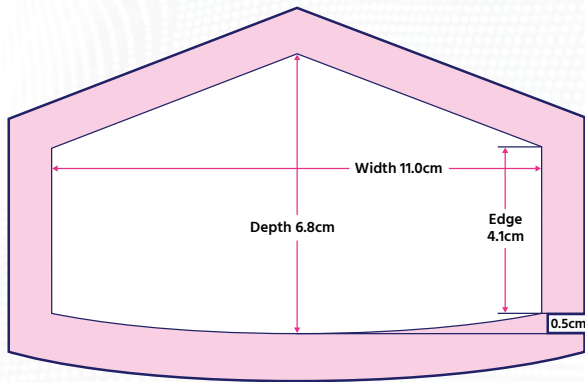
**DIMENSIONS OF APERTURE**

Total Depth: 2.68 in/6.8 cm

Width: 4.33 in/11.0 cm

Edge: 1.61 in/4.1 cm

Curve: 0.20 in/0.5 cm

Note: The curve of the lower edge of the aperture is an arc of a circle of radius 12.0 in/30.5 cm, whose centre is on the vertical centre line of the aperture.

2 THE WICKETS**2.1 Bails**

Overall 4.31 in/10.95 cm

a = 1.38 in/3.50 cm

b = 2.13 in/5.40 cm

c = 0.81 in/2.06 cm

2.2 Stumps

Height (d) = 28 in/71.1 cm

Diameter (e) - maximum = 1.5 in/3.81 cm; minimum = 1.38 in/3.50 cm

2.3 Overall

Width (f) of wicket 9 in/22.86 cm

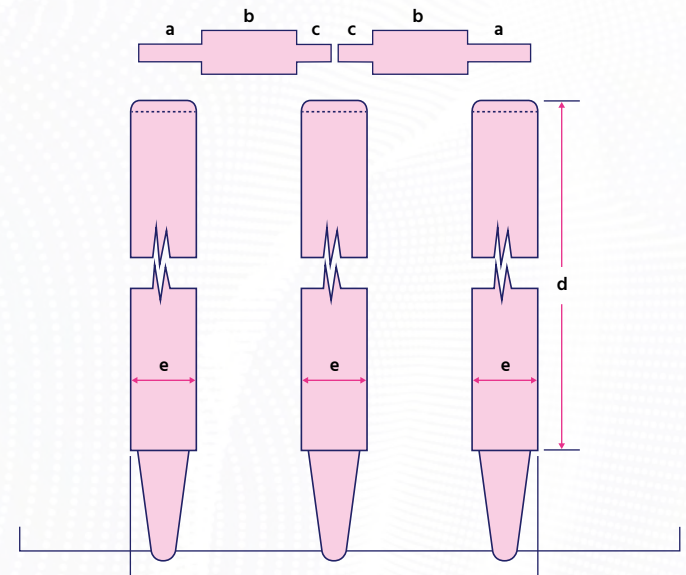

3 WICKET-KEEPING GLOVES

- 3.1 The images below illustrate the requirements of clause 27.2 in relation to:
- no webbing between the fingers;
 - a single piece of non-stretch material between finger and thumb as a means of support; and
 - when a hand wearing the glove has the thumb fully extended, the top edge being taut and not protruding beyond the straight line joining the top of the index finger to the top of the thumb.
- 3.2 Note also the requirement for wicket-keeping gloves to comply with the Clothing and Equipment Regulations in relation to the size and position of marks and logos.



APPENDIX C

THE VENUE

1 THE PITCH AND THE CREASES

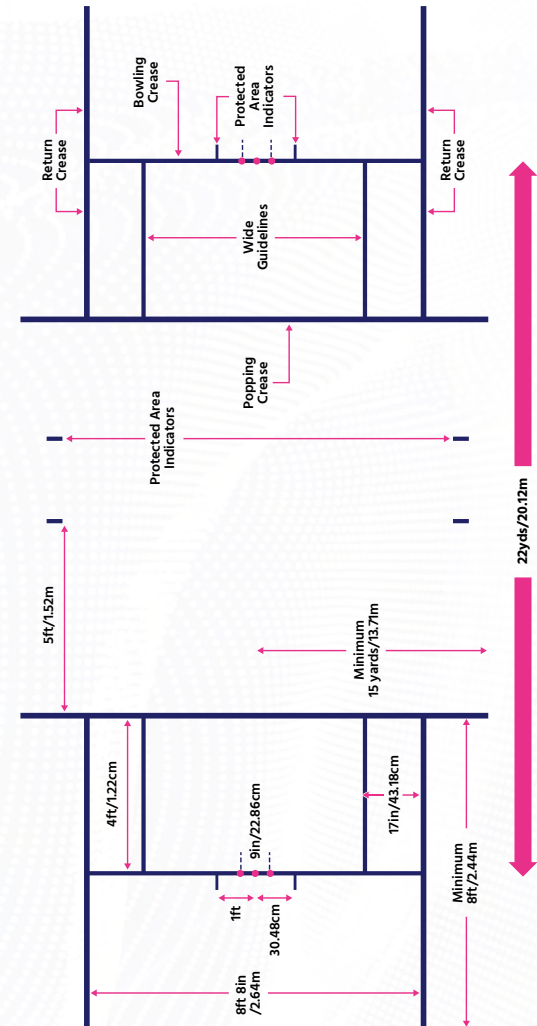

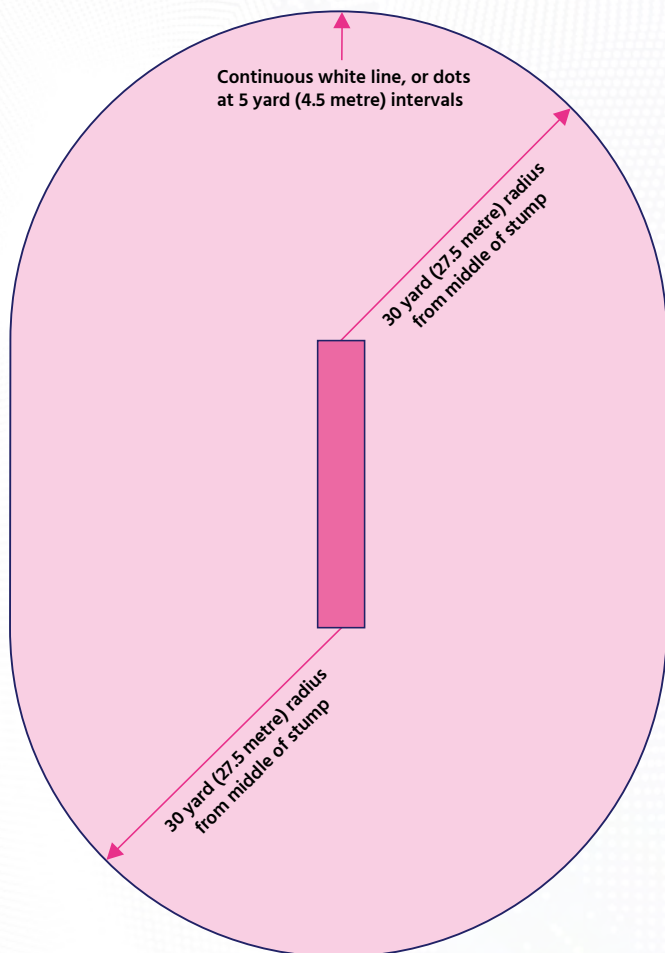
2 RESTRICTION ON THE PLACEMENT OF FIELDERS**3 ADVERTISING ON GROUNDS, PERIMETER BOARDS AND SIGHT-SCREENS****3.1 Advertising on grounds**

3.1.1 The logos on outfield are to be positioned as follows:

- a) Behind the stumps – a minimum of 25.15 yards (23 meters) from the stumps.
- b) Midwicket/cover area – no advertising to be positioned within 30 yards (27.50 meters) of the centre of the pitch being used for the match.

3.1.2 Note: Advertising closer to the stumps as set out above which is required to meet 3D requirements for broadcasters may be permitted, subject to prior ICC approval having been obtained.

3.2 Perimeter boards

3.2.1 Advertising on perimeter boards placed in front of the sight-screens is permitted save that the predominant colour of such advertising shall be of a contrasting colour to that of the ball.

3.2.2 Advertising on perimeter boards behind the stumps at both ends shall not contain moving, flashing or flickering images and operators should ensure that the images are only changed or moved at a time that will not be distracting to the players or the umpires.

3.2.3 The brightness of any electronic images shall be set at a level so that it is not a distraction to the players or umpires.

3.3 Sight-screens

3.3.1 Sight-screens shall be provided at both ends of all grounds.

3.3.2 Advertising shall be permitted on the sight-screen behind the striker, providing it is removed for the subsequent over from that end.

3.3.3 Such advertising shall not contain flashing or flickering images and particular care should be taken by the operators that the advertising is not changed at a time which is distracting to the umpire.

4 MARKINGS ON OUTFIELD

With the permission of the Ground Authority, a bowler may use paint to make a small marking on the outfield for the purposes of identifying their run-up. Paint used for this purpose shall be any colour other than white.

APPENDIX D

DECISION REVIEW SYSTEM (DRS) AND THIRD UMPIRE PROTOCOL

1 GENERAL

1.1 Minimum requirements for use of DRS and appointment of third umpire

- 1.1.1 Save with the express written consent of the ICC General Manager – Cricket, the Home Board shall ensure the live television broadcast of all T20I matches played in its country.
- 1.1.2 Where matches are broadcast, the camera specification set out below shall be mandatory as a minimum requirement.

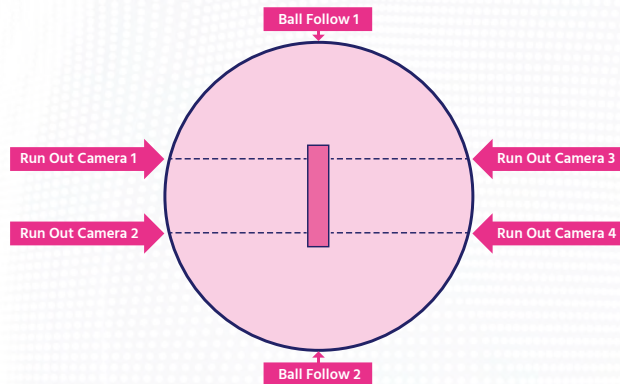

- 1.1.3 Where the camera specification set out above is provided, a third umpire shall be appointed to the match.
- 1.1.4 The provisions of paragraphs 1.1.1, 1.1.2, and 1.1.3 above shall not apply for matches between a Full Member country and Associate Member countries (whose matches have been granted T20I status) and for matches between such Associate Member countries.
- 1.1.5 If the minimum requirements for DRS to be used are satisfied, both participating Boards may agree to employ the DRS for a T20I match. Otherwise, the third umpire shall be appointed and empowered to use broadcast replays to make decisions that are referred to him/her in accordance with paragraph 2 (Umpire Reviews).

- 1.1.6 The table below summarises the minimum requirements for DRS to be used, and the regulations around the appointment of the third umpire:

	THIRD UMPIRE (NON-DRS)	DRS
Minimum Requirement	Cameras Specification detailed in paragraph 1.1.2.	Cameras – Specification detailed in paragraph 1.1.2. Technology. – Approved ball-tracking technology. – Approved sound-based edge detection technology.
Third Umpire Appointment	Appointed by Home Board. From the home country. From ICC Elite Panel or International Panel of umpires.	Appointed by the Home Board. From ICC Elite Panel or International Panel of umpires.
Third Umpire Jurisdiction	Umpire Reviews only.	Umpire Reviews and Player Reviews.
Replays that can be used	The third umpire shall only have access to replays of any camera images. Other technology which may be in use by the broadcaster for broadcast purposes (for example, ball-tracking technology, sound-based edge detection technology, and heat-based edge detection technology) shall not be used during Umpire Reviews.	Any replay, stump microphone audio or technology detailed in paragraph 3.8.1 below.
ICC Technical Officer	Not required.	The ICC shall appoint an independent technology expert (ICC Technical Officer) to be present at every series in which the DRS is used to assist the third umpire and to protect the integrity of the DRS process.

- 1.1.7 The Home Board shall ensure that a separate room is provided for the third umpire and that he/she has access to the television equipment and technology (where DRS is used) so as to be in the best position to facilitate the referral and/or consultation processes referred to in paragraphs 2 (Umpire Review) and 3 (Player Review) below.

2 UMPIRE REVIEW

In the circumstances detailed in paragraphs 2.1, 2.2, 2.3 and 2.4 below, the on-field umpire shall have the discretion to refer the decision to the third umpire or, in the case of paragraphs 2.2, and 2.4, to consult with the third umpire before making the decision.

Save for requesting the umpire to review his/her decision under paragraph 3 (Player Review) below, players may not appeal to the on-field umpires to use the Umpire Review. Breach of this provision may constitute dissent and the player may be subject to disciplinary action under the ICC Code of Conduct for Players and Player Support Personnel.

2.1 Run Out, Stumped, Bowled and Hit Wicket Decisions

- 2.1.1 The relevant on-field umpire shall be entitled to refer an appeal for run-out, stumped, bowled or hit wicket to the third umpire.
- 2.1.2 An on-field umpire wishing to refer a decision to the third umpire shall signal to the third umpire by making the shape of a TV screen with his/her hands.
- 2.1.3 In the case of a referral of a bowled, hit wicket or stumped decision, the third umpire shall first check the fairness of the delivery (all modes of No ball except for the bowler using an Illegal Bowling Action, subject to the proviso that the third umpire may review whether the bowler has used a prohibited Specific Variation under Article 6.2 of the Illegal Bowling Regulations). If the delivery was not a fair delivery the third umpire shall indicate that the batsman is Not out and advise the on-field umpire to signal No ball. See also paragraph 2.5 below.
- 2.1.4 Additionally, if the third umpire finds the batsman is Out by another mode of dismissal (excluding LBW), or Not out by any mode of dismissal (excluding LBW), he/she shall notify the on-field umpire so that the correct decision is made.
- 2.1.5 If the third umpire decides that the batsman is Out, a red light shall be displayed; if the third umpire decides that the batsman is Not out, a green light shall be displayed. Should the third umpire be temporarily unable to respond, a white light (where available) shall remain illuminated throughout the period of interruption to signify to the on-field umpires that Umpire Reviews are temporarily unavailable, in which case the decision shall be taken by the on-field umpire. As an alternative to the red/green light system, the replay screen (where available) may be used for the purpose of conveying the third umpire's decision, in line with the ICC Big Screen Policy.

2.2 Caught Decisions, Obstructing the Field

- 2.2.1 Where the bowler's end umpire is unable to decide upon a Fair Catch or a Bump Ball, or if, on appeal from the fielding side, the batsman obstructed the field, he/she shall first consult with the striker's end umpire.

- 2.2.2 Should both on-field umpires require assistance from the third umpire to make a decision, the bowler's end umpire shall firstly take a decision on-field after consulting with the striker's end umpire, before consulting by two-way radio with the third umpire. Such consultation shall be initiated by the bowler's end umpire to the third umpire by making the shape of a TV screen with his/her hands, followed by a Soft Signal of Out or Not out made with the hands close to the chest at chest height. If the third umpire advises that the replay evidence is inconclusive, the on-field decision communicated at the start of the consultation process shall stand.
- 2.2.3 The third umpire shall determine whether the batsman has been caught, whether the delivery was a Bump Ball, or if the batsman obstructed the field. However, in reviewing the television replay(s), the third umpire shall first check the fairness of the delivery for all decisions involving a catch (all modes of No ball except for the bowler using an Illegal Bowling Action, subject to the proviso that the third umpire may review whether the bowler has used a prohibited Specific Variation under Article 6.2 of the Illegal Bowling Regulations) and whether the batsman has hit the ball. If the delivery was not a fair delivery or if it is clear to the third umpire that the batsman did not hit the ball he/she shall indicate to the bowler's end umpire that the batsman is Not out caught, and in the case of an unfair delivery, advise the bowler's end umpire to signal No ball. See also paragraph 2.5 below. Additionally, if it is clear to the third umpire that the batsman is Out by another mode of dismissal (excluding LBW), or Not out by any mode of dismissal (excluding LBW), he/she shall notify the bowler's end umpire so that the correct decision can be made.
- 2.2.4 The third umpire shall communicate his/her decision as set out in paragraph 2.1.5.

2.3 Boundary Decisions

- 2.3.1 The bowler's end umpire shall be entitled to refer to the third umpire for a decision on:
 - 2.3.1.1 whether a four or six has been scored;
 - 2.3.1.2 whether a fielder had any part of his/her person in contact with the ball when he touched the boundary; or
 - 2.3.1.3 whether the fielder had any part of his/her person in contact with the ball when he had any part of his person grounded beyond the boundary.
- 2.3.2 A decision shall be made immediately and cannot be changed thereafter.
- 2.3.3 If the television evidence is inconclusive as to whether or not a boundary has been scored, the default presumption shall be in favour of no boundary being awarded.
- 2.3.4 Where the bowler's end umpire wishes to use the assistance of the third umpire in this circumstance, he/she shall communicate with the third umpire by use of a two-way radio and the third umpire shall convey his/her decision to the bowler's end umpire by the same method.

- 2.3.5 The third umpire may initiate contact with the on-field umpire by two-way radio if TV coverage shows a boundary line infringement or incident that appears not to have been acted upon by the on-field umpires.

2.4 Batsmen Running to the Same End

- 2.4.1 Where both batsmen have run to the same end and the on-field umpires are uncertain over which batsman made his/her ground first, the on-field umpires may consult with the third umpire.
- 2.4.2 The procedure set out in paragraph 2.3.4 shall apply.

2.5 No Balls

- 2.5.1 If the bowler's end umpire is uncertain as to the fairness of the delivery following a dismissal, either affecting the validity of the dismissal or which batsman is dismissed, he/she shall be entitled to request the batsman to delay leaving the field and to check the fairness of the delivery with the third umpire. Communication with the third umpire shall be by two-way radio.
- 2.5.2 The third umpire shall check all modes of No ball except for the bowler using an Illegal Bowling Action (subject to the proviso that the third umpire may review whether the bowler has used a prohibited Specific Variation under Article 6.2 of the Illegal Bowling Regulations). The third umpire shall apply clause 21.5 when deciding whether a No ball should have been called (and must therefore be satisfied that none of the three conditions in clause 21.5 have been met before calling a No ball).
- 2.5.3 If the delivery was not a fair delivery, the bowler's end umpire shall indicate that the batsman is Not out and signal No ball (except in the case of a dismissal for obstructing the field, which may still be effected despite a No ball being called, in which case the bowler's end umpire shall indicate that the relevant batsman is Out and additionally call a No ball).
- 2.5.4 If a No ball is called following the check by the third umpire, the batting side shall benefit from the reversal of the dismissal and the one run for the No ball, but shall not benefit from any runs that may subsequently have accrued from the delivery had the on-field umpire originally called a No ball. Where the batsmen crossed while the ball was in the air before being caught, the batsmen shall remain at the same ends as if the striker had been dismissed, but no runs shall be credited to the striker even if one (or more) runs were completed prior to the catch being taken.

2.6 Cameras On or Over the Field of Play

- 2.6.1 The on-field umpires shall be entitled to refer to the third umpire for a decision as to whether the ball has at any time during the normal course of play come into contact with any part of the camera, its apparatus or its cables above the playing area, as contemplated in clause 20.13.

- 2.6.2 Where an on-field umpire wishes to use the assistance of the third umpire in this circumstance, he/she shall communicate with the third umpire by use of a two-way radio and the third umpire shall convey his/her decision to the bowler's end umpire by the same method.
- 2.6.3 A decision shall be made immediately and cannot be changed thereafter. If the television evidence is inconclusive as to whether or not the ball has come into contact with any part of the camera, its apparatus or its cables above the playing area, the default presumption shall be in favour of no contact having been made.
- 2.6.4 The third umpire may initiate contact with the on-field umpire by two-way radio if TV coverage shows the ball to have been in contact with any part of the camera or its cables above the playing area as envisaged under this paragraph.

3 PLAYER REVIEW

The following paragraphs shall operate in addition to and in conjunction with paragraph 2 (Umpire Review).

3.1 Circumstances in which a Player Review may be requested

- 3.1.1 A player may request a review of any decision taken by the on-field umpires concerning whether or not a batsman is dismissed, with the exception of 'Timed Out' (Player Review).
- 3.1.2 No other decisions made by the umpires are eligible for a Player Review with the exception of Fair Catch/Bump Ball (even after the third umpire has been consulted and the decision communicated).
- 3.1.3 Only the batsman involved in a dismissal may request a Player Review of an Out decision and only the captain (or acting captain) of the fielding team may request a Player Review of a Not out decision.
- 3.1.4 A decision concerning whether or not a batsman is dismissed that could have been the subject of a Umpire Review under paragraph 2 is eligible for a Player Review as soon as it is clear that the on-field umpire has chosen not to initiate the Umpire Review.

3.2 The manner of requesting the Player Review

- 3.2.1 The request shall be made by the player making a 'T' sign with both forearms at head height.
- 3.2.2 The total time elapsed between the ball becoming dead and the review request being made shall be no more than 15 seconds. The only exception permitted shall be when an Umpire Review for Fair Catch or Bump Ball (as permitted in paragraph 2.2 above) is required to answer an appeal for a caught decision, in which case either team is able to request a Player Review of that caught decision within 15 seconds of the decision being communicated. The bowler's end umpire shall provide the relevant player with a prompt after 10 seconds if the request has not been made at that time and the player shall request the review immediately thereafter. If the on-field umpires believe that a request has not been made within the 15 second time limit, they shall decline the request for a Player Review.

- 3.2.3 The captain may consult with the bowler and other fielders, and the two batsmen may consult with each other prior to deciding whether to request a Player Review. Under no circumstances is any player permitted to query an umpire about any aspect of a decision before deciding on whether or not to request a Player Review. If the on-field umpires believe that the captain or either batsman has received direct or indirect input emanating other than from the players on the field, then they may at their discretion decline the request for a Player Review. In particular, signals from the dressing room must not be given.
- 3.2.4 No replays, either at normal speed or slow motion, shall be shown on a big screen to spectators until the 15 second time limit allowed for requesting a Player Review has elapsed. The only exception to this provision is where a Player Review of a caught decision is requested after the Umpire Review of a Fair Catch or Bump Ball has concluded, as detailed in paragraph 3.2.2 above (due to the fact that replays may have been shown on the big screen during that Umpire Review process).
- 3.2.5 Where either on-field umpire initiates an Umpire Review, this does not preclude a player seeking a Player Review of a separate incident from the same delivery. The request for a Player Review may be made after the Umpire Review, provided the request is still within the 15 second time limit described in paragraph 3.2.2 above. (See paragraphs 3.9.2 and 3.9.3 below for the process for addressing both an Umpire and Player Review).
- 3.2.6 A request for a Player Review cannot be withdrawn once it has been made.

3.3 The process of consultation

- 3.3.1 On receipt of an eligible and timely request for a Player Review, the relevant on-field umpire shall make the sign of a shape of a TV screen with his/her hands in the normal way.
- 3.3.2 The relevant on-field umpire shall initiate communication with the third umpire by confirming;
- 3.3.2.1 That a Player Review has been requested,
- 3.3.2.2 The mode of dismissal for which the relevant on-field umpire adjudicated the appeal,
- 3.3.2.3 The decision that has been made (Out or Not out), and;
- 3.3.2.4 For LBW appeals, where relevant, if the bowler's end umpire believed that the striker made no genuine attempt to play the ball with the bat (the default presumption of the third umpire in the absence of any information on this point from the bowler's end umpire shall be that a genuine attempt to play the ball with the bat was made).
- 3.3.3 A two-way consultation process shall begin to investigate whether there is anything that the third umpire can see or hear which would indicate that the on-field umpire should change his/her original decision.

- 3.3.4 The third umpire shall not withhold any factual information which may help in the decision making process. In particular, in reviewing a dismissal, if the third umpire believes that the batsman may instead be Out by any other mode of dismissal, he/she shall advise the on-field umpire accordingly. The process of consultation described in this paragraph in respect of such other mode of dismissal shall then be conducted as if the batsman has been given Not out.
- 3.3.5 The third umpire shall initially check all modes of No ball except for the bowler using an Illegal Bowling Action (subject to the proviso that the third umpire may review whether the bowler has used a prohibited Specific Variation under Article 6.2 of the Illegal Bowling Regulations), where appropriate advising the on-field umpire accordingly.
- 3.3.6 If despite the available technology, the third umpire is unable to decide with a high degree of confidence whether the original on-field decision should be changed, then he/she shall report that the replays are 'inconclusive', and that the on-field decision shall stand. The third umpire shall not give answers conveying likelihoods or probabilities.
- 3.3.7 In circumstances where the television technology (all or parts thereof) is not available to the third umpire or fails for whatever reason, the third umpire shall advise the on-field umpire of this fact but still provide any relevant factual information that may be ascertained from the available television replays and other technology.
- 3.3.8 The on-field umpire shall then make his/her decision based on the information provided by the third umpire, any other factual information offered by the third umpire and his/her recollection and opinion of the original incident.
- 3.3.9 The on-field umpire shall reverse his/her decision if the nature of the supplementary information received from the third umpire leads him/her to conclude that his/her original decision was incorrect.

3.4 Review of LBW Decisions

- 3.4.1 In assessing whether a batsman is Out LBW in accordance with clause 36, the third umpire shall first judge whether the delivery is fair (as set out in clause 36.1.1), and second, whether or not the ball has touched the bat before being intercepted by any part of the striker's person (as set out in clause 36.1.3).
- 3.4.2 If the batsman is still eligible to be Out, the ball-tracking technology shall then present three pieces of information to the third umpire relating to the path of the ball:
- 3.4.2.1 The point of pitching (where applicable) (PITCHING).
- 3.4.2.2 The position of the ball at the point of first interception (IMPACT).
- 3.4.2.3 Whether the ball would have hit the wicket (WICKET).

3.4.3 This Decision Review System (DRS) and Third Umpire Protocol includes a category of Umpire's Call, which shall be the conclusion reported where the technology indicates a marginal decision in respect of either the point of first interception or whether the ball would have hit the stumps.

3.4.4 PITCHING

3.4.4.1 The interpretation of "pitches in line between wicket and wicket" in clause 36.1.2 shall refer to the position of the centre of the ball at the point of pitching, in relation to the Pitching Zone.

3.4.4.2 The Pitching Zone is defined as a two dimensional area on the pitch between both sets of stumps with its boundaries consisting of the base of both sets of stumps and a line between the outside of the outer stumps at each end.

3.4.4.3 Where applicable, the ball-tracking technology shall report that the ball pitched in one of the following three areas in relation to the Pitching Zone:

In Line	The centre of the ball was inside the Pitching Zone.
Outside Off	The centre of the ball was outside, and to the off side of, the Pitching Zone.
Outside Leg	The centre of the ball was outside, and to the leg side of, the Pitching Zone.

3.4.4.4 Subject to the satisfaction of the other elements of clause 36.1, the batsman can be Out if the ball-tracking technology reports that the ball pitched Outside Off or In Line, but the batsman shall be Not out if the ball pitched Outside Leg.

3.4.5 IMPACT

3.4.5.1 The interpretation of "the (first) point of impact, even if in above the level of the bails, is between wicket and wicket" in clause 36.1.4 shall refer to position of the ball at the point of first interception, in relation to the Impact Zone.

3.4.5.2 The Impact Zone is defined as a three dimensional space extending between both wickets to an indefinite height and with its boundaries consisting of a line between the outside of the outer stumps at each end.

3.4.5.3 The ball-tracking technology shall report that the point of first interception was in one of the following categories in relation to the Impact Zone:

In Line	The centre of the ball was inside the Impact Zone.
Umpire's Call	Some part of the ball was inside the Impact Zone, but the centre of the ball was outside the Impact Zone, with the further sub-category of 'Umpire's Call (off side)' where the centre of the ball was to the off side of the Impact Zone and the bowler's end umpire communicates to the third umpire that no genuine attempt to play the ball was made by the batsman.
Outside	No part of the ball was inside the Impact Zone, with the further sub-categories of 'Outside (off)' and 'Outside (leg)' to indicate the location of the point of first interception in relation to the Impact Zone when the bowler's end umpire communicates to the third umpire that no genuine attempt to play the ball was made by the batsman.

3.4.5.4 Where a Not out decision is being reviewed, and it is judged that the batsman has made a genuine attempt to play the ball, the ball-tracking technology must report that the point of first interception was In Line for the batsman to be eligible to be given Out, otherwise the batsman shall remain Not out.

3.4.5.5 Where a Not out decision is being reviewed, and it is judged that the batsman has made no genuine attempt to play the ball, the ball-tracking technology must report that the point of impact was In Line, or Umpire's Call (off side), or Outside (off) for the batsman to be eligible to be given Out, otherwise the batsman shall remain Not out.

3.4.5.6 Where an Out decision is being reviewed, and it is judged that the batsman has made a genuine attempt to play the ball, the ball-tracking technology must report that the point of first interception was Outside for the decision to be reversed to Not out, otherwise the batsman shall remain eligible to be given Out.

3.4.5.7 Where an Out decision is being reviewed, and it is judged that the batsman has made no genuine attempt to play the ball, the ball-tracking technology must report that the point of first interception was Outside (leg) for the decision to be reversed to Not out, otherwise the batsman shall remain eligible to be given Out.

3.4.6 WICKET

3.4.6.1 The interpretation of whether “the ball would have hit the wicket” in clause 36.15 shall refer to the position of the ball as it either hits or passes the wicket, in relation to the Wicket Zone.

3.4.6.2 The Wicket Zone is defined as a two dimensional area whose boundaries are the outside of the outer stumps, the base of the stumps and the bottom of the bails.

3.4.6.3 The ball-tracking technology shall report whether the ball would have hit the wicket with reference to the following three categories:

Hitting	The ball was hitting the wicket, and the centre of the ball was inside the Wicket Zone.
Umpire's Call	The ball was hitting the wicket, but the centre of the ball was not inside the Wicket Zone.
Missing	The ball was missing the wicket.

3.4.6.4 Where a Not out decision is being reviewed, the ball-tracking technology must report that the ball was Hitting for the batsman to be eligible to be given Out, otherwise the batsman shall remain Not out.

However, where the evidence shows that the ball was Hitting, the point of first interception was In Line, and the ball pitched In Line or Outside Off, but that:

- The point of first interception was 300cm or more from the stumps; or
- The point of first interception was more than 250cm but less than 300cm from the stumps and the distance between the point of pitching and the point of first interception was less than 40cm,

the on-field decision shall stand (that is, Not out).

3.4.6.5 Where an Out decision is being reviewed, the ball-tracking technology must report that the ball was Missing for the on-field decision to be reversed to Not out, otherwise the batsman shall remain eligible to be given Out.

3.4.7 When the ball strikes the batsman on the full, and the evidence provided by the ball-tracking technology indicates that the ball would have pitched before striking or passing the wicket, there will be no information available from that delivery that will allow the ball-tracking technology to accurately predict the height of the ball after pitching.

3.4.8 With regard to determining whether the ball would have hit the wicket under these circumstances, the ball-tracking technology shall project the line of the ball in accordance with clause 36.2.3 (it is to be assumed that the path of the ball before interception would have continued after interception, irrespective of whether the ball might have pitched subsequently or not), and display the simulated path of the ball from directly above the wicket.

3.4.9 The third umpire shall advise the bowler's end umpire only on the point of first interception and whether the ball would have hit the stumps (in line with the process set out in paragraph 3.4 above), but shall make no comment on the predicted height of the ball after pitching, which shall remain a judgment of the bowler's end umpire.

3.5 The process for communicating the final decision

3.5.1 For Player Reviews concerning potential dismissals, the relevant on-field umpire shall indicate Out by raising his/her finger above his/her head in a normal yet prominent manner or indicate Not out by the call of 'not out' and by crossing his/her hands in a horizontal position side to side in front and above his/her waist three times. Where the decision is a reversal of the on-field umpire's previous decision, he/she shall make the 'revoke last signal' indication immediately prior to the above.

3.5.2 If the mode of dismissal is not obvious or not the same as that on which the original decision was based, then the umpire shall advise the scorers via the third umpire.

3.6 Number of Player Review requests permitted

3.6.1 In each innings, each team shall be allowed to make a maximum of one Player Review request that is categorised as 'Unsuccessful' (as set out in paragraph 3.6.3 below).

3.6.2 Where a request for a Player Review results in the original on-field decision being reversed, then the Player Review shall be categorised as 'Successful' and shall not count towards the innings limit.

3.6.3 Where a request for a Player Review results in the original on-field decision remaining unchanged (other than in the circumstances set out in paragraphs 3.6.4, 3.6.6 or 3.6.8), the Player Review shall be categorised as 'Unsuccessful'.

3.6.4 Where a request for a Player Review of an LBW decision results in the on-field decision remaining unchanged solely on the basis of an Umpire's Call, the Player Review shall be categorised as 'Unchanged – Umpire's Call'. A Player Review categorised as 'Unchanged – Umpire's Call' shall not count towards the innings limit set out in paragraph 3.6.1.

3.6.5 Where, following a request for a Player Review, the original on-field decision of Out is unchanged, but for a different mode of dismissal from the original on-field decision, then the Player Review shall still be categorised as 'Unsuccessful'.

3.6.6 Where, following a request for a Player Review, the original on-field decision of Not out is unchanged on account of the delivery being a No ball (for any reason), thereby not requiring any further evaluation, the Player Review shall not be counted as 'Unsuccessful' and accordingly shall not count towards the innings limit set out in paragraph 3.6.1.

- 3.6.7 Where a Player Review and an Umpire Review are requested from the same delivery and the decision of the third umpire from the Umpire Review renders the Player Review unnecessary (see paragraphs 3.9.2 and 3.9.3), the Player Review request shall be disregarded and accordingly shall not count towards the innings limit set out in paragraph 3.6.1.
- 3.6.8 A Player Review categorised as 'Unsuccessful' may be reinstated by the ICC Match Referee at his/her sole discretion (if appropriate after consultation with the ICC Technical Official and/or the television broadcast director) if the Player Review could not properly be concluded due to a failure of the technology. Any such decision shall be final and shall be taken as soon as possible, being communicated to both teams once all the relevant facts have been ascertained by the ICC Match Referee. A Player Review categorised as 'Unsuccessful' shall not be reinstated if, despite any technical failures, the correct decision could still have been made using the other available technology. Similarly, a Player Review categorised as 'Unsuccessful' shall not be reinstated where the technology worked as intended, but the evidence gleaned from its use was inconclusive.
- 3.6.9 The third umpire shall be responsible for counting the number Player Reviews categorised as 'Unsuccessful' and shall advise the on-field umpires once either team has exhausted their allowance for the innings.
- 3.6.10 The scoreboard shall display, for the innings in progress, the number of Player Reviews remaining available to each team.

CATEGORY OF PLAYER REVIEW	OUTCOME OF PLAYER REVIEW	CONSEQUENCE OF PLAYER REVIEW
Successful (paragraph 3.6.2)	On-field decision reversed	Does not count towards innings limit set out in paragraph 3.6.1
Unsuccessful (paragraphs 3.6.3 and 3.6.5)	On-field decision unchanged	Counts towards innings limit set out in paragraph 3.6.1
Unchanged – Umpire's Call (paragraph 3.6.4)	On-field decision unchanged	Does not count towards innings limit set out in paragraph 3.6.1
No ball – no evaluation required (paragraph 3.6.6)	On-field decision unchanged	Does not count towards innings limit set out in paragraph 3.6.1
Failure of technology (paragraph 3.6.8)	On-field decision unchanged	Does not count towards innings limit set out in paragraph 3.6.1

3.7 Dead ball

- 3.7.1 If following a Player Review request, an original decision of Out is changed to Not out, then the ball is still deemed to have become dead when the original decision was made (as per clause 20.1.1.3). The batting side, while benefiting from the reversal of the dismissal, shall not benefit from any runs that may subsequently have accrued from the delivery had the on-field umpire originally made a Not out decision, other than any No ball penalty that could arise under paragraph 3.3.5 above.
- 3.7.2 If an original decision of Not out is changed to Out, the ball shall retrospectively be deemed to have become dead from the moment of the dismissal event. All subsequent events, including any runs scored, shall be ignored.

3.8 Use of technology

- 3.8.1 The following technology may be used by the third umpire during a Player Review:
- 3.8.1.1 Replays, at any speed, from any available broadcast camera
- 3.8.1.2 Sound from the stump microphones with the replays at normal speed and slow motion
- 3.8.1.3 Approved ball-tracking technology:
- HawkEye (HawkEye Innovations), or;
 - VirtualEye (ARL)
- 3.8.1.4 Approved sound-based edge detection technology:
- Real-Time Snickometer (BBG Sports), or;
 - UltraEdge (HawkEye Innovations)
- 3.8.1.5 Approved heat-based edge detection technology:
- Hot Spot cameras (BBG Sports)
- 3.8.1.6 LED Wickets (using the lights to indicate if the wicket is broken, as set out in paragraph 4.2):
- Zing Bails and Stumps
- 3.8.2 In addition, other forms of technology may be used subject to the ICC being satisfied that the required standards of accuracy and time efficiency can be met.
- 3.8.3 Where practical usage or further testing indicates that any of the above forms of technology cannot reliably provide accurate and timely information, then it may be removed prior to or during a match. The final decision regarding the technology to be used in a given match shall be taken by the ICC Match Referee in consultation with the ICC Technical Official, ICC management and the competing teams' governing bodies.

3.9 Combining Umpire Review with Player Review

- 3.9.1 If an Umpire Review (under paragraph 2) and a request for a Player Review (under paragraph 3) are made following the same delivery but relating to separate modes of dismissal, the following process shall apply.
- 3.9.2 The Umpire Review shall be carried out prior to the Player Review if all of the following conditions apply:
- 3.9.2.1 The Player Review has been requested by the fielding side.
- 3.9.2.2 The Umpire Review and the Player Review both relate to the dismissal of the same batsman.
- 3.9.2.3 If the batsman is out, the number of runs scored from the delivery would be the same for both modes of dismissal.
- 3.9.2.4 If the batsman is out, the batsman on strike for the next delivery would be the same for both modes of dismissal.
- 3.9.3 If the Umpire Review leads the third umpire to make a decision of Out, then this shall be displayed in the usual manner and the Player Review shall not be undertaken. If the Umpire Review results in a Not out decision, then the third umpire shall make no public decision but shall proceed to address the request for a Player Review.
- 3.9.4 For illustration, following an LBW appeal which is given Not out by the bowler's end umpire, the striker sets off for a run, is sent back and there is an appeal for his/her run out. The players request that the LBW decision is reviewed and the umpires request that the run out be reviewed. The four criteria above are satisfied, so the run out referral is determined first. Should the appeal for run out be Out, then there is no requirement for the LBW review to take place.
- 3.9.5 In all other circumstances, the incidents shall be addressed in chronological order. If the conclusion from the first incident is that a batsman is dismissed, then the ball would be deemed to have become dead at that point, rendering investigation of the second incident unnecessary.

4 INTERPRETATION OF PLAYING CONDITIONS

- 4.1 When using a replay to determine the moment at which the wicket has been put down (as per clause 29.1), the third umpire shall deem this to be the first frame in which one of the bails is shown (or can be deduced) to have lost all contact with the top of the stumps and subsequent frames show the bail permanently removed from the top of the stumps.
- 4.2 Where LED Wickets are used (as provided for in paragraph 3.8.1.6) the moment at which the wicket has been put down (as per clause 29.1) shall be deemed to be the first frame in which the LED lights are illuminated and subsequent frames show the bail permanently removed from the top of the stumps.

APPENDIX E**CALCULATIONS****Table 1: Calculation sheet for use when a delay or interruptions occur in the First Innings**

Time	
Net playing time available at start of the match	170 minutes (A)
Time innings in progress	_____ (B)
Playing time lost	_____ (C)
Extra time available	_____ (D)
Time made up from reduced interval	_____ (E)
Effective playing time lost [C – (D + E)]	_____ (F)
Remaining playing time available (A – F)	_____ (G)
G divided by 4.25 (to 2 decimal places)	_____ (H)
Max overs per team [H/2] (round up fractions)	_____ (I)
Maximum overs per bowler [I/5]	_____
Number of Powerplay overs	_____
Rescheduled Playing Hours	
First session to commence or recommence	_____ (J)
Length of innings [I x 4.25] (round up fractions)	_____ (K)
Rescheduled first innings cessation time [J + (K – B)]	_____ (L)
Length of interval	_____ (M)
Second innings commencement time [L + M]	_____ (N)
Rescheduled second innings cessation time [N + K]	_____ *(O)

* Ensure that the match is not finishing earlier than the original or rescheduled cessation time by applying clause 13.7.2. If so, add at least one over to each team and recalculate (I) to (O) above to prevent this from happening.

Table 2: Calculation sheet to check whether an interruption during the First Innings should terminate the innings

Proposed re-start time	_____	(P)
Rescheduled cut-off time allowing for full use of any extra time provision	_____	(Q)
Minutes between P and Q	_____	(R)
Potential overs to be bowled $[R/4.25]$ (round up fractions)	_____	(S)
Number of complete overs faced to date in first innings	_____	(T)
If S is greater than T then revert to Table 1		
If S is less than or equal to T then the first innings is terminated – go to Table 3		

Table 3: Calculation sheet for the start of the Second Innings

Maximum overs to be bowled:

(If first innings was terminated, S from Table 2)	_____	(A)
Scheduled length of innings: $[A \times 4.25]$ (round up fractions)	_____	(B)
Start time	_____	(C)
Scheduled cessation time $[C + B]$	_____	(D)

Overs per bowler and fielding restrictions

Maximum overs per bowler $[A/5]$	_____	overs
Number of Powerplay overs	_____	overs

Table 4: Calculation sheet for use when interruption occurs after the start of the Second Innings

Time

Time at start of innings	_____	(A)
Time at start of interruption	_____	(B)
Time innings in progress	_____	(C)
Restart time	_____	(D)
Length of interruption $[D - B]$	_____	(E)
Additional time available:	_____	(F)
(Any unused provision for 'Extra Time' or for earlier than scheduled start of second innings)		
Total playing time lost $[E - F]$	_____	(G)

Overs

Maximum overs at start of innings	_____	(H)
Overs lost $[G/4.25]$ (rounded down)	_____	(I)
Adjusted maximum length of innings $[H - I]$	_____	(J)
Rescheduled length of innings $[J \times 4.25]$ rounded up]	_____	(K)
Amended cessation time of innings $[D + (K - C)]$	_____	(L)

Overs per bowler and Fielding Restrictions

Maximum overs per bowler $[J/5]$	_____	overs
Number of Powerplay overs	_____	overs

APPENDIX F

PROCEDURE FOR THE SUPER OVER

The following procedure shall apply if the playing conditions provide for a Super Over to decide the winner of a tied match.

- 1 If the match is tied a Super Over is played. If the Super Over is a tie, then subsequent Super Overs shall be played until there is a winner. Unless exceptional circumstances arise, there shall be an unlimited number of Super Overs played to achieve a result. (see Clause 24 below).
- 2 The Super Over involves each team facing one over (unless all out earlier), and the winner shall be the team that scores the most runs from its one over innings.
- 3 The loss of two wickets in the over ends the team's one over innings.
- 4 Each team shall be allowed to make one unsuccessful Player Review in each innings of the Super Over. This entitlement shall apply irrespective of the number of unsuccessful Player Review requests made during the match itself.
- 5 Subject to weather conditions the Super Over will take place on the scheduled day of the match at a time to be determined by the ICC Match Referee. In normal circumstances it shall commence 5 minutes after the conclusion of the match.
- 6 The Super Over will be played until completion, but if there are any delays or interruptions during the Super Over, Extra Time (taken from the start of the first Super Over) is allocated to complete the Super Over or any subsequent Super Overs. The amount of extra time allocated to the Super Over is the greater of;
 - a. the gap between the time at which the match ended and the time the original match would have been scheduled to finish had the entire extra time provision been utilized, or
 - b. 20 minutes.

Should play be delayed prior to or during the Super Over(s) once the playing time lost exceeds the Extra Time allocated, the Super Over(s) shall be abandoned.
- 7 The Super Over shall take place on the pitch allocated for the match (the designated pitch) unless otherwise determined by the umpires in consultation with the Ground Authority and the ICC Match Referee.
- 8 Only nominated players in the match (including activated concussion replacements) may participate in the Super Over. Should any player (including the batsmen and bowler) be unable to continue to participate in the Super Over due to injury, illness or other wholly acceptable reasons, the relevant Playing Conditions as they apply in the match shall also apply in the Super Over.
- 9 Any penalty time being served in the match shall be carried forward to the Super Over.

- 10 The umpires shall stand at the same end as that in which they finished the match.
- 11 The team batting second in the match shall bat first in the Super Over.
- 12 The captain of the fielding team (or his nominee) shall select the ball with which the fielding team shall bowl its over in the Super Over from the box of spare balls provided by the umpires (which shall include the balls used in the match, but no new balls). The team fielding first in the Super Over shall have first choice of ball. The team fielding second may choose to use the same ball as chosen by the team bowling first. If the ball needs to be changed, the Playing Conditions shall apply.
- 13 The fielding side shall choose the end from which it is to bowl its one over.
- 14 Each team's over is played with the same fielding restrictions as apply for the last over in a match played under the ICC Twenty20 International Playing Conditions.
- 15 The winners of the Super Over shall be the team which scored the most runs as per normal playing conditions and irrespective of the number of wickets lost. (See also Clause 3 above).

TIED SUPER OVER - REPEATING THE SUPER OVER PROCEDURE

- 16 If the Super Over is tied, then subsequent Super Overs will be played until there is a winner.
- 17 In normal circumstances any subsequent Super Over will start 5 minutes after the previous Super Over ends. The interval shall be 5 minutes.
- 18 The team batting second in the previous Super Over will bat first in the subsequent Super Over.
- 19 The balls selected for use by each team in the previous Super Over shall be used again by the same team in subsequent Super Overs.
- 20 The fielding side must bowl its over in a subsequent Super Over from the opposite end to which it bowled from in the previous Super Over.
- 21 Any batsman dismissed in any previous Super Over shall be ineligible to bat in the following Super Over.
- 22 The bowler who bowled the over in the previous Super Over shall be ineligible to bowl the over in the subsequent Super Over.
- 23 All other playing conditions will be the same as for the initial Super Over.
- 24 In circumstances where there are unavoidable time constraints, such as, but not limited to, double-header matches which do not allow the completion of multiple Super Over(s) the Home Board may, prior to the start of the series and by notification to the participating teams, limit the number of possible Super Overs.

EXAMPLES - EXTRA TIME AVAILABLE FOR THE SUPER OVER.

Example 1: The match is scheduled to finish at 10.20pm, with 60 minutes of extra time available to be used. The scheduled cut-off time if all the available extra time is used would be 11.20pm. The match runs over time and finishes in a tie at 10.35pm. The Super Over is scheduled to start 5 minutes later at 10.40pm. The extra time available to complete the Super Over would be 40 minutes (as per Clause 5a above).

- The Super Over starts on time but is interrupted at 10.50pm for 10 minutes (leaving 30 minutes of extra time still available).
- Play resumes at 11.00pm with a tied Super Over occurring.
- The second super over is being played but is interrupted at 11.15pm.
- Play does not resume within 30 minutes (being the amount of extra time still available), therefore the Super Over process is abandoned, and the match is a tie.

Example 2: The same match is scheduled to finish at 10.20pm, but with 30 minutes of extra time available to be used. The scheduled cut-off time if all the available extra time is used would be 10.50pm. The match runs over time and finishes in a tie at 10.35pm. The Super Over is scheduled to start 5 minutes later at 10.40pm. The extra time available to complete the Super Over would be 20 minutes (as per Clause 5b above).

APPENDIX G

USE OF ELECTRONIC COMMUNICATIONS EQUIPMENT

The use of electronic communication devices and equipment of any kind to communicate with players on the field of play shall not be permitted, except that broadcaster to player communication shall, with the prior consent of the participating countries, be allowed.

ICC WOMEN'S CHAMPIONSHIP PLAYING CONDITIONS

Effective from 1 September 2019

ICC WOMEN'S CHAMPIONSHIP PLAYING CONDITIONS

CONTENTS

1	THE PLAYERS	8.3
2	THE UMPIRES	8.6
3	THE SCORERS	8.11
4	THE BALL	8.12
5	THE BAT	8.12
6	THE PITCH	8.14
7	THE CREASES	8.16
8	THE WICKETS	8.17
9	PREPARATION AND MAINTENANCE OF THE PLAYING AREA	8.18
10	COVERING THE PITCH	8.20
11	INTERVALS	8.20
12	START OF PLAY; CESSATION OF PLAY	8.21
13	INNINGS	8.23
14	THE FOLLOW-ON	8.27
15	DECLARATION AND FORFEITURE	8.27
16	THE RESULT	8.27
17	THE OVER	8.31
18	SCORING RUNS	8.33
19	BOUNDARIES	8.36
20	DEAD BALL	8.38
21	NO BALL	8.41
22	WIDE BALL	8.44
23	BYE AND LEG BYE	8.46
24	FIELDER'S ABSENCE; SUBSTITUTES	8.47
25	BATTER'S INNINGS	8.49
26	PRACTICE ON THE FIELD	8.50
27	THE WICKET-KEEPER	8.51
28	THE FIELDER	8.53
29	THE WICKET IS DOWN	8.58
30	BATTER OUT OF HER GROUND	8.59
31	APPEALS	8.60
32	BOWLED	8.61
33	CAUGHT	8.62
34	HIT THE BALL TWICE	8.63
35	HIT WICKET	8.64
36	LEG BEFORE WICKET	8.64
37	OBSTRUCTING THE FIELD	8.65

38	RUN OUT	8.67
39	STUMPED	8.68
40	TIMED OUT	8.68
41	UNFAIR PLAY	8.69
42	PLAYERS' CONDUCT	8.81

APPENDIX A DEFINITIONS		8.85
1	The match	8.85
2	Implements and equipment	8.85
3	The playing area	8.86
4	Positioning	8.86
5	Umpires and decision-making	8.87
6	Batters	8.89
7	Fielders	8.89
8	Substitutes and Concussion Replacements	8.89
9	Bowlers	8.90
10	The ball	8.90
11	Runs	8.91
12	The person	8.91
13	Off side/on side; in front of/behind the popping crease.	8.92

APPENDIX B EQUIPMENT		8.93
1	The Bat	8.93
2	The wickets	8.96
3	Wicket-keeping gloves	8.97

APPENDIX C THE VENUE		8.98
1	The pitch and the creases	8.99
2	Restriction on the placement of fielders	8.99
3	Advertising on grounds, perimeter boards and sight-screens	8.100
4	Markings on outfield	8.100

APPENDIX D DECISION REVIEW SYSTEM (DRS) AND THIRD UMPIRE PROTOCOL		8.101
1	General	8.101
2	Umpire Review	8.103
3	Player Review	8.106
4	Interpretation of Playing Conditions	8.115

APPENDIX E CALCULATIONS		8.116
--------------------------------	--	-------

APPENDIX F USE OF ELECTRONIC COMMUNICATIONS EQUIPMENT		8.119
--------------------------------------------------------------	--	-------

PREAMBLE THE SPIRIT OF CRICKET

Cricket owes much of its appeal and enjoyment to the fact that it should be played not only according to the Laws (which are incorporated within these Playing Conditions), but also within the Spirit of Cricket.

The major responsibility for ensuring fair play rests with the captains, but extends to all players, umpires and, especially in junior cricket, teachers, coaches and parents.

Respect is central to the Spirit of Cricket.

Respect your captain, team-mates, opponents and the authority of the umpires.

Play hard and play fair.

Accept the umpire's decision.

Create a positive atmosphere by your own conduct, and encourage others to do likewise.

Show self-discipline, even when things go against you.

Congratulate the opposition on their successes, and enjoy those of your own team.

Thank the officials and your opposition at the end of the match, whatever the result.

Cricket is an exciting game that encourages leadership, friendship and teamwork, which brings together people from different nationalities, cultures and religions, especially when played within the Spirit of Cricket.

1 THE PLAYERS

1.1 Number of players

A match is played between two sides, each of eleven players, one of whom shall be captain.

1.2 Nomination and replacement of players

1.2.1 Each captain shall nominate 11 players plus a maximum of 4 substitute fielders in writing to the ICC Match Referee before the toss. Other than set out in clause 1.2.7, no player (member of the playing eleven) may be changed after the nomination without the consent of the opposing captain.

1.2.2 Only those nominated as substitute fielders shall be entitled to act as substitute fielders during the match, unless the ICC Match Referee, in exceptional circumstances, allows subsequent additions.

1.2.3 All those nominated including those nominated as substitute fielders, as well as any Concussion Replacements, must be eligible to play for that particular team and by such nomination the nominees shall warrant that they are so eligible.

1.2.4 In addition, by their nomination, the nominees shall be deemed to have agreed to abide by all the applicable ICC Regulations pertaining to international cricket and in particular, the Clothing and Equipment Regulations, the Code of Conduct for Players and Player Support Personnel (hereafter referred to as the ICC Code of Conduct), the Anti-Racism Code for Players and Player Support Personnel, the Anti-Doping Code and the Anti-Corruption Code.

- 1.2.5 A player or player support personnel who has been suspended from participating in a match shall not, from the toss of the coin and for the remainder of the match thereafter:
- 1.2.5.1 Be nominated as, or carry out any of the duties or responsibilities of a substitute fielder, or
- 1.2.5.2 Enter any part of the playing area (which shall include the field of play and the area between the boundary and the perimeter boards) at any time, including any scheduled or unscheduled breaks in play.
- A player who has been suspended from participating in a match shall be permitted from the toss of the coin and for the remainder of the match thereafter be permitted to enter the players' dressing room provided that the players' dressing room (or any part thereof) for the match is not within the playing area described in clause 1.2.5.2 above (for example, the player is not permitted to enter the on-field 'dug-out').
- 1.2.6 A player who has been suspended from participating in a match shall be permitted from the toss of the coin and for the remainder of the match thereafter be permitted to enter the players' dressing room provided that the players' dressing room (or any part thereof) for the match is not within the playing area described in clause 1.2.5.2 above (for example, the player is not permitted to enter the on-field 'dug-out').
- 1.2.7 If a player sustains a concussion or suspected concussion as a result of a head or neck injury during the course of the relevant match, a Concussion Replacement may be permitted in the following circumstances:
- 1.2.7.1 the head or neck injury must have been sustained during play and within the playing area described in clause 1.2.5.2 above;
- 1.2.7.2 a concussion or suspected concussion must have been formally diagnosed by the Team Medical Representative or in consultation with the Match Day Doctor;
- 1.2.7.3 the Team Medical Representative or Team Manager shall submit a Concussion Replacement Request to the ICC Match Referee on a standard form, which shall:
- 1.2.7.3.1 identify the player who has sustained the concussion or suspected concussion;
- 1.2.7.3.2 specify the incident in which the concussion or suspected concussion was sustained, including the time at which it occurred;
- 1.2.7.3.3 confirm that, following an examination, the Team Medical Representative, or in consultation with the Match Day Doctor, believes or suspects that the player has sustained a concussion as a result of the incident specified in 1.2.7.3.2 above; and
- 1.2.7.3.4 identify the requested Concussion Replacement, who shall be a like-for-like replacement for the player who has sustained the concussion or suspected concussion.

- 1.2.7.4 The Concussion Replacement Request must be submitted as soon as possible after the incident specified in 1.2.7.3.2 if a Concussion Replacement is to be permitted.
- 1.2.8 The ICC Match Referee should ordinarily approve a Concussion Replacement Request if the replacement is a like-for-like player whose inclusion will not excessively advantage her team for the remainder of the match.
- 1.2.8.1 In assessing whether the nominated Concussion Replacement should be considered a like-for-like player, the ICC Match Referee should consider the likely role the concussed player would have played during the remainder of the match, and the normal role that would be performed by the nominated Concussion Replacement.
- 1.2.8.2 If the ICC Match Referee believes that the inclusion of the nominated Concussion Replacement, when performing their normal role, would excessively advantage their team, the Match Referee may impose such conditions upon the identity and involvement of the Concussion Replacement as he/she sees fit, in line with the overriding objective of facilitating a like-for-like replacement for the concussed player.
- 1.2.8.3 The ICC Match Referee may, in reviewing a Concussion Replacement Request made in accordance with clause 1.2.7.3, request any such further information as may be required in order to make the determination required under clauses 1.2.8.1 and 1.2.8.2.
- 1.2.9 The decision of the ICC Match Referee in relation to any Concussion Replacement Request shall be final and neither team shall have any right of appeal.
- 1.2.10 Once the Concussion Replacement has been approved by the ICC Match Referee, the replaced player shall play no further part in the match.
- 1.2.11 Both the Concussion Replacement and the replaced player shall be considered to have played in the match for records and statistical purposes.

1.3 Captain

- 1.3.1 If at any time the captain is not available, a deputy shall act for her.
- 1.3.2 If a captain is not available to nominate the players, then any person associated with that team may act as her deputy to do so. See clause 1.2.
- 1.3.3 At any time after the nomination of the players, only a nominated player can act as deputy in discharging the duties and responsibilities of the captain as stated in these Playing Conditions, including at the toss. See clause 13.4 (The toss).

1.4 Responsibility of captains

The captains are responsible at all times for ensuring that play is conducted within The Spirit of Cricket as well as within these Playing Conditions.

2 THE UMPIRES

2.1 Appointment and attendance

The following rules for the selection and appointment of umpires shall be followed as far as it is practicable to do so:

- 2.1.1 The umpires shall control the game as required by these Playing Conditions, with absolute impartiality and shall be present at the ground at least 90 minutes before the scheduled start of play.
- 2.1.2 The Home Board shall appoint all umpires to stand in each match. For non-televised matches the Home Board shall appoint two on-field umpires and a reserve umpire. The responsibility of the reserve umpire will be to act as an emergency on-field umpire and carry out tasks as prescribed for the third and fourth umpires. For all televised matches, the Home Board shall appoint two on-field umpires, a third umpire and a reserve (fourth) umpire.
- 2.1.3 It's recommended that such umpires shall only be selected from its umpires on the 'Elite Panel', 'International Panel', 'First Class Panel' or female umpires on the 'ICC Development Panel'.
- 2.1.4 As early as possible before each match, the Home Board will advise the ICC of the names of its appointees and will advise the Manager of the visiting team of all umpires' names.
- 2.1.5 It's recommended that in matches the Home Board shall appoint match officials in the following manner:
 - 2.1.5.1 For all matches, only 'Elite Panel', 'International Panel', 'First Class Panel' or female umpires on the 'ICC Development Panel' shall be appointed as the on-field umpires or reserve umpire.
 - 2.1.5.2 For televised matches where DRS is not used, only 'Elite Panel', 'International Panel' or 'First Class Panel' umpires shall be appointed as the third umpire. The third umpire shall act as the emergency umpire and officiate with regards to TV replays. The fourth umpire shall act as the emergency third umpire.
 - 2.1.5.3 For televised matches where DRS is used, only 'Elite Panel' or 'International Panel' umpires shall be appointed to third umpire who shall officiate in regard to the DRS. The reserve (fourth) umpire shall act as the emergency on-field umpire (not the third umpire).
 - 2.1.5.4 The playing conditions governing the use of the DRS and the third umpire are included in Appendix D.
- 2.1.6 The Home Board shall appoint a local match referee for all matches (ICC Match Referee) from the International Panel of Referees.
- 2.1.7 Neither team will have a right of objection to the appointment of any umpire or ICC Match Referee.

2.2 Change of umpire

An umpire shall not be changed during the match, other than in exceptional circumstances, unless he/she is injured or ill.

2.3 Consultation with Home Board

Before the match the umpires shall consult with the Home Board to determine;

- 2.3.1 the balls to be used during the match. See clause 4 (The ball).
- 2.3.2 the hours of play and the times and durations of any agreed intervals.
- 2.3.3 which clock or watch and back-up time piece is to be used during the match.
- 2.3.4 the boundary of the field of play. See clause 19 (Boundaries).
- 2.3.5 the use of covers. See clause 10 (Covering the pitch).
- 2.3.6 any special conditions of play affecting the conduct of the match and inform the scorers of agreements in 2.3.2, 2.3.3, 2.3.4 and 2.3.6.

2.4 The wickets, creases and boundaries

Before the toss and during the match, the umpires shall satisfy themselves that

- 2.4.1 the wickets are properly pitched. See clause 8 (The wickets).
- 2.4.2 the creases are correctly marked. See clause 7 (The creases).
- 2.4.3 the boundary of the field of play complies with the requirements of clauses 19.1 (Determining the boundary of the field of play), 19.2 (Identifying and marking the boundary) and 19.3 (Restoring the boundary).

2.5 Conduct of the match, implements and equipment

Before the toss and during the match, the umpires shall satisfy themselves that

- 2.5.1 the conduct of the match is strictly in accordance with these Playing Conditions.
- 2.5.2 the implements used in the match conform to the following:
 - 2.5.2.1 clause 4 (The ball).
 - 2.5.2.2 externally visible requirements of clause 5 (The bat) and paragraph 1 of Appendix B.
 - 2.5.2.3 either clauses 8.2 (Size of stumps) and 8.3 (The bails).
- 2.5.3 no player uses equipment other than that permitted. See paragraph 2 of Appendix A. Note particularly therein the interpretation of 'protective helmet'.
- 2.5.4 the wicket-keeper's gloves comply with the requirements of clause 27.2 (Gloves).

2.6 Fair and unfair play

The umpires shall be the sole judges of fair and unfair play.

2.7 Fitness for play

- 2.7.1 It is solely for the umpires together to decide whether either conditions of ground, weather or light or exceptional circumstances mean that it would be dangerous or unreasonable for play to take place.
- Conditions shall not be regarded as either dangerous or unreasonable merely because they are not ideal.
- The fact that the grass and the ball are wet does not warrant the ground conditions being regarded as unreasonable or dangerous.
- 2.7.2 Conditions shall be regarded as dangerous if there is actual and foreseeable risk to the safety of any player or umpire.
- 2.7.3 Conditions shall be regarded as unreasonable if, although posing no risk to safety, it would not be sensible for play to proceed.
- 2.7.4 If the umpires consider the ground is so wet or slippery as to deprive the bowler of a reasonable foothold, the fielders of the power of free movement, or the batters of the ability to play their strokes or to run between the wickets, then these conditions shall be regarded as so bad that it would be dangerous and unreasonable for play to take place.

2.8 Suspension of play in dangerous or unreasonable circumstances

- 2.8.1 All references to ground include the pitch. See clause 6.1 (Area of pitch).
- 2.8.2 If at any time the umpires together agree that the conditions of ground, weather or light, or any other circumstances are dangerous or unreasonable, they shall immediately suspend play, or not allow play to start or to recommence. The decision as to whether conditions are so bad as to warrant such action is one for the umpires alone to make, following consultation with the ICC Match Referee.
- 2.8.3 If circumstances are warranted, the umpires shall stop play and instruct the Ground Authority to take whatever action they can and use whatever equipment is necessary to remove as much dew as possible from the outfield when conditions become unreasonable or dangerous. The umpires may also instruct the ground staff to take such action during scheduled and unscheduled breaks in play.
- 2.8.4 The umpires shall disregard any shadow on the pitch from the stadium or from any permanent object on the ground.
- 2.8.5 Light Meters
- It is the responsibility of each Home Board to supply light meters to the match officials to be used in accordance with these playing conditions.
- 2.8.5.1 All light meters shall be uniformly calibrated.
- 2.8.5.2 The umpires shall be entitled to use light meter readings as a guideline for determining whether the light is fit for play in accordance with the criteria set out in clause 2.8.2 above.

- 2.8.5.3 Light meter readings may accordingly be used by the umpires:
- 2.8.5.3.1 To determine whether there has been at any stage a deterioration or improvement in the light.
- 2.8.5.3.2 As benchmarks for the remainder of a match.
- 2.8.6 Use of artificial lights
- If in the opinion of the umpires, natural light is deteriorating to an unfit level, they shall authorize the Ground Authority to use the available artificial lighting so that the match can commence or continue in acceptable conditions.
- In the event of power failure or lights malfunction, the provisions relating to the delay or interruption of play due to bad weather or light shall apply.
- 2.8.7 When there is a suspension of play it is the responsibility of the umpires to monitor conditions. They shall make inspections as often as appropriate, unaccompanied by any players or officials. Immediately the umpires together agree that the conditions are no longer dangerous or unreasonable they shall call upon the players to resume play.
- 2.8.8 The safety of all persons within the ground is of paramount importance to the ICC. In the event that of any threatening circumstance, whether actual or perceived (including for example weather, pitch invasions, act of God, etc.), then the umpires, on the advice of the ICC Match Referee, should suspend play and all players and officials should immediately be asked to leave the field of play in a safe and orderly manner and to relocate to a secure and safe area (depending on each particular threat) pending the satisfactory passing or resolution of such threat or risk to the reasonable satisfaction of the umpires, the ICC Match Referee, the head of the relevant Ground Authority, the head of ground security and/or the police as the circumstances may require.
- 2.8.9 Where play is suspended under clause 2.8.8 above the decision to abandon or resume play shall be the responsibility of the ICC Match Referee who shall act only after consultation with the head of ground security and the police.

2.9 Position of umpires

The umpires shall stand where they can best see any act upon which their decision may be required.

Subject to this over-riding consideration, the bowler's end umpire shall stand in a position so as not to interfere with either the bowler's run-up or the striker's view.

The striker's end umpire may elect to stand on the off side instead of the on side of the pitch, provided he/she informs the captain of the fielding side, the striker and the other umpire.

2.10 Umpires changing ends

Shall not apply.

2.11 Disagreement and dispute

Where there is disagreement or dispute about any matter, the umpires together shall make the final decision. See also clause 31.6 (Consultation by umpires).

2.12 Umpire's decision

An umpire may alter any decision provided that such alteration is made promptly. This apart, an umpire's decision, once made, is final.

2.13 Signals

2.13.1 The following code of signals shall be used by umpires.

2.13.1.1 Signals made while the ball is in play

No ball – by extending one arm horizontally.

Out – by raising an index finger above the head.
(If not out, the umpire shall call Not out.)

Wide – by extending both arms horizontally.

Dead ball – by crossing and re-crossing the wrists below the waist.

2.13.1.2 When the ball is dead, the bowler's end umpire shall repeat the signals in clause 2.13.1.1, with the exception of the signal for Out, to the scorers.

2.13.1.3 The signals listed below shall be made to the scorers only when the ball is dead.

Boundary 4 – by waving an arm from side to side finishing with the arm across the chest.

Boundary 6 – by raising both arms above the head.

Bye – by raising an open hand above the head.

Five Penalty runs awarded to the batting side – by repeated tapping of one shoulder with the opposite hand.

Five Penalty runs awarded to the fielding side – by placing one hand on the opposite shoulder.

Leg bye – by touching a raised knee with the hand.

Revoke last signal – by touching both shoulders, each with the opposite hand.

Short run – by bending one arm upwards and touching the nearer shoulder with the tips of the fingers.

Free Hit – after signaling the No ball, the bowler's end umpire extends one arm straight upwards and moves it in a circular motion.

Powerplay Over – by rotating his/her arm in a large circle.

The following signal is for Level 4 player conduct offences. The signal has two parts, both of which should be acknowledged separately by the scorers.

Level 4 conduct

Part 1 – by putting one arm out to the side of the body and repeatedly raising it and lowering it.

Part 2 – by raising an index finger, held at shoulder height, to the side of the body.

2.13.1.4 All the signals in clause 2.13.1.3 are to be made by the bowler's end umpire except that for Short run, which is to be signalled by the umpire at the end where short running occurs. However, the bowler's end umpire shall be responsible both for the final signal of Short run to the scorers and, if more than one run is short, for informing them as to the number of runs to be recorded.

2.13.2 The umpire shall wait until each signal to the scorers has been separately acknowledged by a scorer before allowing play to proceed.

If several signals are to be used, they should be given in the order that the events occurred.

2.14 Informing the umpires

Wherever the umpires are to receive information from captains or other players under these Playing Conditions, it will be sufficient for one umpire to be so informed and for him/her to inform the other umpire.

2.15 Correctness of scores

Consultation between umpires and scorers on doubtful points is essential. The umpires shall, throughout the match, satisfy themselves as to the correctness of the number of runs scored, the wickets that have fallen and, where appropriate, the number of overs bowled.

The umpires shall ensure that they are able to contact the scorers at any time during the match and at its conclusion to address any issues relating to the correctness of scores.

3 THE SCORERS**3.1 Appointment of scorers**

Two scorers shall be appointed to record all runs scored, all wickets taken and, where appropriate, number of overs bowled.

3.2 Correctness of scores

The scorers shall frequently check to ensure that their records agree and consult with the umpires if necessary. See clause 2.15 (Correctness of scores).

3.3 Acknowledging signals

The scorers shall accept all instructions and signals given to them by the umpires and shall immediately acknowledge each separate signal.

4 THE BALL**4.1 Weight and size**

The ball, when new, shall weigh not less than 4.94 ounces/140 g, nor more than 5.31 ounces/151 g, and shall measure not less than 8.25 in/21.0 cm, nor more than 8.88 in/22.5 cm in circumference.

4.2 Approval and control of balls

- 4.2.1 The Home Board shall provide the best available high quality white cricket balls (e.g. Kookaburra 'Turf' or its equivalent) and spare used balls for changing during a match, which shall also be of the same brand. Note: The Home Board shall be required to advise the Visiting Board of the brand of ball to be used in the match(es) at least 30 days prior to the start of the match(es).
- 4.2.2 The fielding captain or her nominee may select the ball(s) with which she wishes to bowl from the supply provided by the Home Board. The reserve umpire shall take a box containing at least 6 new balls to the dressing room and supervise the selection of the ball(s).
- 4.2.3 The umpires shall retain possession of the match ball(s) throughout the duration of the match when play is not actually taking place.
- 4.2.4 During play umpires shall periodically and irregularly inspect the condition of the ball and shall retain possession of it at the fall of a wicket, a drinks interval, or any other disruption in play.

4.3 New ball

- 4.3.1 Each fielding team shall have two new balls for its innings, to be used in alternate overs i.e. one from each end.
- 4.3.2 In a match reduced to 25 overs or less per side before the first innings commences, each team shall have only one new ball for its Innings.

4.4 Ball lost or becoming unfit for play

If, during play, the ball cannot be found or recovered or the umpires agree that it has become unfit for play through normal use, the umpires shall replace it with a ball which has had wear comparable with that which the previous ball had received before the need for its replacement. When the ball is replaced, the umpire shall inform the batters and the fielding captain.

5 THE BAT**5.1 The bat**

- 5.1.1 The bat consists of two parts, a handle and a blade.
- 5.1.2 The basic requirements and measurements of the bat are set out in this clause with detailed specifications in paragraph 1 of Appendix B.

5.2 The handle

- 5.2.1 The handle is to be made principally of cane and/or wood.
- 5.2.2 The part of the handle that is wholly outside the blade is defined to be the upper portion of the handle. It is a straight shaft for holding the bat.
- 5.2.3 The upper portion of the handle may be covered with a grip as defined in paragraph 1.2.2 of Appendix B.

5.3 The blade

- 5.3.1 The blade comprises the whole of the bat apart from the handle as defined in clause 5.2 and in paragraph 1.3 of Appendix B.
- 5.3.2 The blade shall consist solely of wood.

5.4 Protection and repair

Subject to the specifications in paragraph 1.4 of Appendix B. and providing clause 5.5 is not contravened,

- 5.4.1 solely for the purposes of
either
protection from surface damage to the face, sides and shoulders of the blade
or
repair to the blade after surface damage,
material that is not rigid, either at the time of its application to the blade or subsequently, may be placed on these surfaces.
- 5.4.2 for repair of the blade after damage other than surface damage
- 5.4.2.1 solid material may be inserted into the blade.
- 5.4.2.2 The only material permitted for any insertion is wood with minimal essential adhesives.
- 5.4.3 to prevent damage to the toe, material may be placed on that part of the blade but shall not extend over any part of the face, back or sides of the blade.

5.5 Damage to the ball

- 5.5.1 For any part of the bat, covered or uncovered, the hardness of the constituent materials and the surface texture thereof shall not be such that either or both could cause unacceptable damage to the ball.
- 5.5.2 Any material placed on any part of the bat, for whatever purpose, shall similarly not be such that it could cause unacceptable damage to the ball.
- 5.5.3 For the purpose of this clause, unacceptable damage is any change that is greater than normal wear and tear caused by the ball striking the uncovered wooden surface of the blade.

5.6 Contact with the ball

In these clauses,

- 5.6.1 reference to the bat shall imply that the bat is held in the batter's hand or a glove worn on her hand, unless stated otherwise.
- 5.6.2 contact between the ball and any of 5.6.2.1 to 5.6.2.4
 - 5.6.2.1 the bat itself
 - 5.6.2.2 the batter's hand holding the bat
 - 5.6.2.3 any part of a glove worn on the batter's hand holding the bat
 - 5.6.2.4 any additional materials permitted under 5.4
 - shall be regarded as the ball striking or touching the bat or being struck by the bat.

5.7 Bat size limits

- 5.7.1 The overall length of the bat, when the lower portion of the handle is inserted, shall not be more than 38 in/96.52 cm.
- 5.7.2 The blade of the bat shall not exceed the following dimensions:
 - Width: 4.25 in/10.8 cm
 - Depth: 2.64 in/6.7 cm
 - Edges: 1.56 in/4.0 cm

Furthermore, it should also be able to pass through a bat gauge as described in paragraph 1.6 of Appendix B.
- 5.7.3 The handle shall not exceed 52% of the overall length of the bat.
- 5.7.4 The material permitted for covering the blade in clause 5.4.1 shall not exceed 0.04 in/0.1 cm in thickness.
- 5.7.5 The maximum permitted thickness of protective material placed on the toe of the blade is 0.12 in/0.3 cm.

5.8 Categories of bat

- 5.8.1 Type A bats conform to clauses 5.1 to 5.7 inclusive.
- 5.8.2 Only Type A bats may be used in ODI matches.

6 THE PITCH**6.1 Area of pitch**

The pitch is a rectangular area of the ground 22 yards/20.12 m in length and 10 ft/3.05 m in width. It is bounded at either end by the bowling creases and on either side by imaginary lines, one each side of the imaginary line joining the centres of the two middle stumps, each parallel to it and 5 ft/1.52 m from it. If the pitch is next to an artificial pitch which is closer than 5 ft/1.52 m from the middle stumps, the pitch on that side will extend only to the junction of the two surfaces. See clauses 8.1 (Description, width and pitching) and 7.2 (The bowling crease).

6.2 Fitness of pitch for play

The umpires shall be the sole judges of the fitness of the pitch for play. See clauses 2.7 (Fitness for play) and 2.8 (Suspension of play in dangerous or unreasonable conditions).

6.3 Selection and preparation

Before the match, the Ground Authority shall be responsible for the selection and preparation of the pitch. During the match, the umpires shall control its use and maintenance.

- 6.3.1 The Ground Authority shall ensure that during the period prior to the start of play and during intervals, the pitch area shall be roped off so as to prevent unauthorised access. (The pitch area shall include an area at least 2 metres beyond the rectangle made by the crease markings at both ends of the pitch).
- 6.3.2 The reserve umpire shall ensure that, prior to the start of play and during any intervals, only authorised staff, the match officials, players, team coaches and authorised television personnel shall be allowed access to the pitch area. Such access shall be subject to the following limitations:
 - 6.3.2.1 Only captains and team coaches may walk on the actual playing surface of the pitch area (outside of the crease markings).
 - 6.3.2.2 Access to the pitch area by television personnel shall be restricted to one camera crew (including one or two television commentators) of the official licensed television broadcaster(s) (but not news crews).
 - 6.3.2.3 No spiked footwear shall be permitted.
 - 6.3.2.4 No one shall be permitted to bounce a ball on the pitch, strike it with a bat or cause damage to the pitch in any other way.
 - 6.3.2.5 Access shall not interfere with pitch preparation.
- 6.3.3 In the event of any dispute, the ICC Match Referee will rule and his/her ruling will be final.

6.4 Changing the pitch

- 6.4.1 If the on-field umpires decide that it is dangerous or unreasonable for play to continue on the match pitch, they shall stop play and immediately advise the ICC Match Referee.
- 6.4.2 The on-field umpires and the ICC Match Referee shall then consult with both captains.
- 6.4.3 If the captains agree to continue, play shall resume.
- 6.4.4 If the decision is not to resume play, the on-field umpires together with the ICC Match Referee shall consider whether the existing pitch can be repaired and the match resumed from the point it was stopped. In considering whether to authorise such repairs, the ICC Match Referee must consider whether this would place either side at an unfair advantage, given the play that had already taken place on the dangerous pitch.

- 6.4.5 If the decision is that the existing pitch cannot be repaired, then the match is to be abandoned with the following consequences:
- 6.4.5.1 In the event of the required number of overs to constitute a match having been completed at the time the match is abandoned, the result shall be determined according to the provisions of clause 16.4.2.
- 6.4.5.2 In the event of the required number of overs to constitute a match not having been completed, the match will be abandoned as a no result.
- 6.4.6 If the abandonment occurs on the day of the match, the ICC Match Referee shall consult with the Home Board with the objective of finding a way for a new match (including a new nomination of teams and toss) to commence on the same date and venue. Such a match may be played either on the repaired pitch or on another pitch, subject to the ICC Match Referee and the relevant Ground Authority both being satisfied that the new pitch will be of the required ODI standard. The playing time lost between the scheduled start time of the original match and the actual start time of the new match will be covered by the provisions of clause 12.
- 6.4.7 If it is not possible to start a new match on the scheduled day of the match, the relevant officials from the participating Boards shall agree on whether the match can be replayed within the existing tour schedule.
- 6.4.8 Throughout the above decision making processes, the ICC Match Referee shall keep informed both captains and the head of the Ground Authority. The head of the Ground Authority shall ensure that suitable and prompt public announcements are made.

6.5 Non-turf pitches

- 6.5.1 ODI matches shall be played on natural turf pitches.
- Note:** Home Boards may, prior to the commencement of the series, seek the approval of ICC to use a hybrid pitch as an alternate to a natural turf pitch.
- 6.5.2 The use of PVA and other adhesives in the preparation of pitches is not permitted.

7 THE CREASES

7.1 The creases

The positions of a bowling crease, a popping crease and two return creases shall be marked by white lines, as set out in clauses 7.2, 7.3 and 7.4, at each end of the pitch. See paragraph 1 of Appendix C.

7.2 The bowling crease

The bowling crease, which is the back edge of the crease marking, is the line that marks the end of the pitch, as in clause 6.1 (Area of pitch). It shall be 8 ft 8 in/2.64 m in length.

7.3 The popping crease

The popping crease, which is the back edge of the crease marking, shall be in front of and parallel to the bowling crease and shall be 4 ft/1.22 m from it. The popping crease shall be marked to a minimum of 15 yards/13.71 m on either side of the imaginary line joining the centres of the two middle stumps and shall be considered to be unlimited in length.

7.4 The return creases

The return creases, which are the inside edges of the crease markings, shall be at right angles to the popping crease at a distance of 4 ft 4 in/1.32 m either side of the imaginary line joining the centres of the two middle stumps. Each return crease shall be marked from the popping crease to a minimum of 8 ft/2.44 m behind it and shall be considered to be unlimited in length.

7.5 Additional Crease Markings

As a guideline to the umpires for the calling of Wides on the offside, the crease markings detailed in paragraph 1 of Appendix C may be marked in white at each end of the pitch.

8 THE WICKETS

8.1 Description, width and pitching

Two sets of wickets shall be pitched opposite and parallel to each other in the centres of the bowling creases. Each set shall be 9 in/22.86 cm wide and shall consist of three wooden stumps with two wooden bails on top. See paragraph 2 of Appendix B.

8.2 Size of stumps

The tops of the stumps shall be 28 in/71.12 cm above the playing surface and shall be dome shaped except for the bail grooves. The portion of a stump above the playing surface shall be cylindrical apart from the domed top, with circular section of diameter not less than 1.38 in/3.50 cm nor more than 1.5 in/3.81 cm. See paragraph 2 of Appendix B.

For televised matches, the Home Board may provide a slightly larger cylindrical stump to accommodate the stump camera. When the larger stump is used, all three stumps must be exactly the same size.

8.3 The bails

- 8.3.1 The bails, when in position on top of the stumps,
- shall not project more than 0.5 in/1.27 cm above them.
 - shall fit between the stumps without forcing them out of the vertical.
- 8.3.2 Each bail shall conform to the following specifications. See paragraph 2 of Appendix B.
- Overall length 4.31 in/10.95 cm
 - Length of barrel 2.13 in /5.40 cm
 - Longer spigot 1.38 in/3.50 cm
 - Shorter spigot 0.81 in/2.06 cm.

- 8.3.3 The two spigots and the barrel shall have the same centre line.
- 8.3.4 Devices aimed at protecting player safety by limiting the distance that a bail can travel off the stumps will be allowed, subject to the approval of the Home Board and the ICC.

8.4 Dispensing with bails

The umpires may agree to dispense with the use of bails, if necessary. If they so agree then no bails shall be used at either end. The use of bails shall be resumed as soon as conditions permit. See clause 29.4 (Dispensing with bails).

8.5 LED Wickets

The use of approved LED Wickets is permitted. Refer also to paragraphs 3.8.1.6 and 4.2 of Appendix D.

9 PREPARATION AND MAINTENANCE OF THE PLAYING AREA

9.1 Rolling

The pitch shall not be rolled during the match except as permitted in clauses 9.1.1 and 9.1.2.

9.1.1 Frequency and duration of rolling

During the match the pitch may be rolled at the request of the captain of the side batting second, for a period of not more than 7 minutes, before the start of the second innings.

9.1.2 Rolling after a delayed start

In addition to the rolling permitted above, if, after the toss and before the first innings of the match, the start is delayed, the captain of the batting side may request that the pitch be rolled for not more than 7 minutes. However, if the umpires together agree that the delay has had no significant effect on the state of the pitch, they shall refuse such request for rolling of the pitch.

9.1.3 Choice of rollers

If there is more than one roller available the captain of the batting side shall choose which one is to be used.

The following shall apply in addition to clause 9.1:

- 9.1.4 Prior to the scheduled time for the toss, the artificial drying of the pitch and outfield shall be at the discretion of the Ground Authority. Thereafter and throughout the match the drying of the outfield may be undertaken at any time by the Ground Authority, but the drying of the affected area of the pitch shall be carried out only on the instructions and under the supervision of the umpires. The umpires shall be empowered to have the pitch dried without reference to the captains at any time they are of the opinion that it is unfit for play.
- 9.1.5 The umpires may instruct the Ground Authority to use any available equipment, including any roller for the purpose of drying the pitch and making it fit for play.
- 9.1.6 An absorbent roller may be used to remove water from the covers including the cover on the match pitch.

9.2 Clearing debris from the pitch

9.2.1 The pitch shall be cleared of any debris

9.2.1.1 between innings. This shall precede rolling if any is to take place.

9.2.1.2 at all intervals for meals.

9.2.2 The clearance of debris in clause 9.2.1 shall be done by sweeping, except where the umpires consider that this may be detrimental to the surface of the pitch. In this case the debris must be cleared from that area by hand, without sweeping.

9.2.3 In addition to 9.2.1, debris may be cleared from the pitch by hand, without sweeping, before mowing and whenever either umpire considers it necessary.

9.3 Mowing

9.3.1 Responsibility for mowing

9.3.1.1 All mowings which are carried out before the match shall be the sole responsibility of the Ground Authority.

9.4 Watering the pitch

The pitch shall not be watered during the match.

9.5 Re-marking creases

Creases shall be re-marked whenever either umpire considers it necessary.

9.6 Maintenance of footholes

The umpires shall ensure that the holes made by the bowlers and batters are cleaned out and dried whenever necessary to facilitate play.

The umpires shall allow, if necessary, the returfing of footholes made by the bowlers in their delivery strides, or the use of quick-setting fillings for the same purpose.

In addition, the umpires shall see that wherever possible and whenever it is considered necessary, action is taken during all intervals in play to do whatever is practicable to improve the bowler's footholes.

9.7 Securing of footholds and maintenance of pitch

During play, umpires shall allow the players to secure their footholds by the use of sawdust provided that no damage to the pitch is caused and that clause 41 (Unfair play) is not contravened.

9.8 Protection and preparation of adjacent pitches during matches

The protection (by way of an appropriate cover) and preparation of pitches which are adjacent to the match pitch will be permitted during the match subject to the following:

- 9.8.1 Such measures will only be possible if requested by the Ground Authority and approved by the umpires before the start of the match.
- 9.8.2 Approval should only be granted where such measures are unavoidable and will not compromise the safety of the players or their ability to execute their actions with complete freedom.

- 9.8.3 The preparation work shall be carried out under the supervision of the reserve umpire.
- 9.8.4 The consent of the captains is not required but the umpires shall advise both captains and the ICC Match Referee before the start of the match on what has been agreed.

10 COVERING THE PITCH

10.1 Before the match

The use of covers before the match is the responsibility of the Ground Authority and may include full covering if required.

The pitch shall be entirely protected against rain up to the commencement of play.

However, the Ground Authority shall grant suitable facility to the captains to inspect the pitch before the nomination of their players and to the umpires to discharge their duties as laid down in clauses 2 (The umpires), 6 (The pitch), 7 (The creases), 8 (The wickets), and 9 (Preparation and maintenance of the playing area).

10.2 During the match

The pitch shall be entirely protected against rain up to the commencement of play, and for the duration of the period of the match.

The covers must totally protect the pitch and also the pitch surroundings, to a minimum of 5 metres either side of the pitch, and any worn or soft areas in the outfield.

The bowlers' run-ups shall be covered during inclement weather, in order to keep them dry, to a distance of at least 10 x 10 metres.

10.3 Removal of covers

All covers (including "hessian" or "scrim" covers used to protect the pitch against the sun) shall be removed not later than 2 ½ hours before the scheduled start of play provided it is not raining at the time, but the pitch will be covered again if rain falls prior to the commencement of play.

11 INTERVALS

11.1 An interval

- 11.1.1 The following shall be classed as intervals.
- Intervals between innings.
 - Intervals for meals.
 - Intervals for drinks.
 - Any other agreed interval.
- 11.1.2 Only these intervals shall be considered as scheduled breaks for the purposes of clause 24.2.6.

11.2 Duration of interval

- 11.2.1 Except in circumstances provided for in clause 11.2.2 below, there shall be a 30 minute interval between innings, taken from the call of Time before the interval until the call of Play on resumption after the interval.
- 11.2.2 Home Boards may adjust the length of the interval between innings to suit their own requirements, provided that the scheduled length of the interval in an uninterrupted match is a minimum of 30 minutes and a maximum of 45 minutes

11.3 Allowance for interval between innings

Law 11.3 shall not apply.

11.4 Changing agreed times of intervals

- 11.4.1 If the innings of the team batting first is completed prior to the scheduled time for the interval, the interval shall take place immediately and the innings of the team batting second will commence after the interval.

Note: The prescribed interval timings above may be reduced by the ICC Match Referee taking into account the intention of not having a prolonged interval after a lengthy interruption close to the conclusion of the innings of the team batting first. However, the minimum interval shall not be less than 10 minutes.

11.5 Intervals for drinks

- 11.5.1 Two drinks breaks per session shall be permitted, each 1 hour apart. The provisions of Law 15.9 shall be strictly observed except that under conditions of extreme heat the umpires may permit extra intervals for drinks.
- 11.5.2 An individual player may be given a drink either on the boundary edge or at the fall of a wicket, on the field, provided that no playing time is wasted. No other drinks shall be taken onto the field without the permission of the umpires. Any player taking drinks onto the field shall be dressed in proper cricket attire (subject to the wearing of bibs – refer to the note in clause 24.1.4).

11.6 Scorers to be informed

The umpires shall ensure that the scorers are informed of all agreements about hours of play and intervals and of any changes made thereto as permitted under this clause.

12 START OF PLAY; CESSATION OF PLAY

12.1 Call of Play

The bowler's end umpire shall call Play before the first ball of the match and on the resumption of play after any interval or interruption.

12.2 Call of Time

The bowler's end umpire shall call Time, when the ball is dead, at the end of any session of play or as required by these Playing Conditions. See also clause 20.3 (Call of Over or Time).

12.3 Removal of bails

After the call of Time, the bails shall be removed from both wickets.

12.4 Starting a new over

Another over shall always be started at any time during the match, unless an interval is to be taken in the circumstances set out in clause 12.5.2, if the umpire, walking at normal pace, has arrived at the position behind the stumps at the bowler's end before the time agreed for the next interval has been reached.

12.5 Completion of an over

Other than at the end of the match,

12.5.1 if the agreed time for an interval is reached during an over, the over shall be completed before the interval is taken, except as provided for in clause 12.5.2.

12.5.2 when less than 3 minutes remains before the time agreed for the next interval, the interval shall be taken immediately if

either a batter is dismissed or retires or

the players have occasion to leave the field

whether this occurs during an over or at the end of an over.

Except at the end of an innings, if an over is thus interrupted it shall be completed on the resumption of play.

12.6 Conclusion of match

12.6.1 The match is concluded

12.6.1.1 as soon as a result as defined in clauses 16.1 to 16.5 (The result) is reached.

12.6.1.2 as soon as the prescribed number of overs have been completed.

12.6.2 The match is concluded if, without a conclusion having been reached under 12.6.1, the players leave the field for adverse conditions of ground, weather or light, or in exceptional circumstances, and no further play is possible.

12.7 Hours of Play; Minimum Overs Requirement

12.7.1 To be determined by the Home Board subject to there being 2 sessions of 3 hours 10 minutes each, separated by a 45 minute interval between innings.

Note: The playing hours of matches scheduled to take place at venues where dew is likely to be a factor should be determined so as to ensure that the effect of any dew is minimised.

12.8 Minimum Over Rates

12.8.1 The minimum over rate to be achieved in ODI Matches shall be 15.79 overs per hour.

12.8.2 The actual over rate shall be calculated at the end of each innings by the umpires.

12.8.3 In calculating the actual over rate for the match, allowances will be given as follows:

12.8.3.1 The time lost as a result of treatment given to a player by an authorised medical personnel on the field of play;

12.8.3.2 The time lost as a result of a player being required to leave the field as a result of a serious injury;

12.8.3.3 The time taken for all third umpire referrals and consultations and any umpire or player reviews;

12.8.3.4 The time lost as a result of time wasting by the batting side; and

12.8.3.5 The time lost due to all other circumstances that are beyond the control of the fielding side.

12.8.4 In the event of any time allowances being granted to the fielding team under clause 12.8.3.4 above (time wasting by batting team), then such time shall be deducted from the allowances granted to such batting team in the determination of its over rate.

12.8.5 If a batting team is bowled out within the time determined for that innings pursuant to these playing conditions (taking into account all of the time allowances set out above), the fielding side shall be deemed to have complied with the required minimum over rate.

12.8.6 The current over rate of the fielding team (+/- overs compared to the minimum rate required), shall be advised by the 3rd umpire every 30 minutes as a minimum.

13 INNINGS**13.1 Number of innings**

13.1.1 A match shall be one innings for each side.

13.2 Alternate innings

Each side shall take their innings alternately.

13.3 Completed innings

A side's innings is to be considered as completed if any of the following applies

13.3.1 the side is all out.

13.3.2 at the fall of a wicket or the retirement of a batter, further balls remain to be bowled but no further batter is available to come in.

13.3.3 the prescribed number of overs have been bowled to the batting side.

13.4 The toss

The captains shall toss a coin for the choice of innings, on the field of play and under the supervision of the ICC Match Referee, not earlier than 30 minutes, nor later than 15 minutes before the scheduled or any rescheduled time for the start of play. Note, however, the provisions of clause 1.3 (Captain).

13.5 Decision to be notified

As soon as the toss is completed, the captain of the side winning the toss shall decide whether to bat or to field and shall notify the opposing captain and the umpires of this decision. Once notified, the decision cannot be changed.

13.6 Duration of Match

- 13.6.1 All matches will consist of one innings per side, each innings being limited to a maximum of 50 overs. All matches shall be of one day's scheduled duration.
- 13.6.2 For clarity there are no reserve days for any match played under these playing conditions.

13.7 Length of Innings**13.7.1 Uninterrupted Matches.**

- 13.7.1.1 Each team shall bat for 50 overs unless all out earlier.
- 13.7.1.2 If the team fielding first fails to bowl the required number of overs by the scheduled time for cessation of the first innings, play shall continue until the required number of overs has been bowled. The interval shall be reduced to enable the second innings to commence at the scheduled time, subject to there being a minimum interval of 30 minutes. The team batting second shall receive its full quota of 50 overs irrespective of the number of overs it bowled in the scheduled time for the cessation of the first innings.
- 13.7.1.3 If the team batting first is dismissed in less than 50 overs, the team batting second shall be entitled to bat for 50 overs.
- 13.7.1.4 If the team fielding second fails to bowl 50 overs by the scheduled cessation time, the hours of play shall be extended until the required number of overs has been bowled or a result is achieved.
- 13.7.1.5 Penalties shall apply for slow over rates (refer ICC Code of Conduct).

13.7.2 Delayed or Interrupted Matches

- 13.7.2.1 Delay or Interruption to the Innings of the Team Batting First (see paragraph 1 of Appendix E)
- 13.7.2.1.1 When playing time has been lost the revised number of overs to be bowled in the match shall be based on a rate of 15.79 overs per hour, which is inclusive of the provision of drinks intervals, in the total remaining time available for play.

- 13.7.2.1.2 The revision of the number of overs should ensure, whenever possible, that both teams have the opportunity of batting for the same number of overs. The team batting second shall not bat for a greater number of overs than the first team unless the latter completed its innings in less than its allocated overs. To constitute a match, a minimum of 20 overs have to be bowled to the side batting second, subject to a result not being achieved earlier.
- 13.7.2.1.3 As soon as the total minutes of playing time remaining is less than the completed overs faced by Team 1 multiplied by 3.8, then the first innings is terminated and the provisions of 13.7.2.2 below take effect.
- 13.7.2.1.4 A fixed time will be specified for the commencement of the interval, and also the close of play for the match, by applying a rate of 15.79 overs per hour. When calculating the length of playing time available for the match, or the length of either innings, the timing and duration of all relative delays, extensions in playing hours, interruptions in play, and intervals, excluding those for drinks, will be taken into consideration. This calculation must not cause the match to finish earlier than the original or rescheduled time for cessation of play on the final scheduled day for play. If required the original time shall be extended to allow for one extra over for each team.
- 13.7.2.1.5 If the team fielding first fails to bowl the revised number of overs by the specified time, play shall continue until the required number of overs have been bowled or the innings is completed.
- 13.7.2.1.6 Penalties shall apply for slow over rates (refer to the ICC Code of Conduct).
- 13.7.2.2 Delay or Interruption to the Innings of the Team Batting Second (see paragraph 2 of Appendix E)
- 13.7.2.2.1 When playing time has been lost and, as a result, it is not possible for the team batting second to have the opportunity of receiving its allocated, or revised allocation of overs in the playing time available, the number of overs shall be reduced at a rate of 15.79 overs per hour, which is inclusive of the provision of drinks intervals, in respect of the lost playing time. Should the calculations result in a fraction of an over the fraction shall be ignored.

- 13.7.2.2.2 In addition, should the innings of the team batting first have been completed prior to the scheduled, or re-scheduled time for the commencement of the interval, then any calculation relating to the revision of overs shall not be effective until an amount of time equivalent to that by which the second innings started early has elapsed.
- 13.7.2.2.3 To constitute a match, a minimum of 20 overs have to be bowled to the team batting second subject to a result not being achieved earlier.
- 13.7.2.2.4 The team batting second shall not bat for a greater number of overs than the first team unless the latter completed its innings in less than its allocated overs.
- 13.7.2.2.5 A fixed time will be specified for the close of play by applying a rate of 15.79 overs per hour. With the exception of drinks intervals, the timing and duration of all relative delays, extensions in playing hours and interruptions in play, will be taken into consideration in specifying this time.
- 13.7.2.2.6 If the team fielding second fails to bowl the revised overs by the scheduled or re-scheduled close of play, the hours of play shall be extended until the overs have been bowled or a result achieved.
- 13.7.2.2.7 Penalties shall apply for slow over rates (refer to the ICC Code of Conduct).

13.8 Extra Time

The participating countries may agree to provide for extra time where the start of play is delayed or play is suspended.

13.9 Number of Overs per Bowler

- 13.9.1 No bowler shall bowl more than 10 overs in an innings.
- 13.9.2 In a delayed or interrupted match where the overs are reduced for both teams or for the team bowling second, no bowler may bowl more than one-fifth of the total overs allowed.
- 13.9.3 Where the total overs is not divisible by 5, one additional over shall be allowed to the maximum number per bowler necessary to make up the balance.
- 13.9.4 In the event of a bowler breaking down and being unable to complete an over, the remaining balls will be allowed by another bowler. Such part of an over will count as a full over only in so far as each bowler's limit is concerned.
- 13.9.5 The scoreboard shall show the total number of overs bowled and the number of overs bowled by each bowler.

14 THE FOLLOW-ON

Shall not apply.

15 DECLARATION AND FORFEITURE

Shall not apply.

16 THE RESULT

16.1 A Win – one-innings match

- 16.1.1 The side which has scored in its one innings a total of runs in excess of that scored by the opposing side in its one completed innings shall win the match. See clause 13.3 (Completed innings). Note also 16.4 (Winning hit or extras).
- 16.1.2 Save for circumstances where a match is awarded to a team as a consequence of the opposing team's refusal to play (clause 16.2), a result can be achieved only if both teams have had the opportunity of batting for at least 20 overs, unless one team has been all out in less than 20 overs or unless the team batting second scores enough runs to win in less than 20 overs.
- 16.1.3 Save for circumstances where a match is awarded to a team as a consequence of the opposing team's refusal to play (clause 16.2), all matches in which both teams have not had an opportunity of batting for a minimum of 20 overs, shall be declared a No Result.

16.2 ICC Match Referee awarding a match

- 16.2.1 A match shall be lost by a side which either
- 16.2.1.1 concedes defeat or
- 16.2.1.2 in the opinion of the ICC Match Referee refuses to play and the ICC Match Referee shall award the match to the other side.
- 16.2.2 If an umpire considers that an action by any player or players might constitute a refusal by either side to play then the umpires together shall inform the ICC Match Referee of this fact. The ICC Match Referee shall together with the umpires ascertain the cause of the action. If the ICC Match Referee, after due consultation with the umpires, then decides that this action does constitute a refusal to play by one side, he/she shall so inform the captain of that side. If the captain persists in the action the ICC Match Referee shall award the match in accordance with clause 16.2.1.2 above.
- 16.2.3 If action as in clause 16.2.2 above takes place after play has started and does not constitute a refusal to play the delay or interruption in play shall be dealt with in the same manner as provided for in clauses 13.7.2 (Delayed and Interrupted Matches) and 11.4 (Changing agreed times for intervals) above.

Note: In addition to the consequences of any refusal to play prescribed under this clause, any such refusal, whether temporary or final, may result in disciplinary action being taken against the captain and team responsible under the Code of Conduct.

16.3 All other matches – A Tie or No Result**16.3.1 A Tie**

The result of a match shall be a Tie when all innings have been completed and the scores are equal.

If the scores are equal, the result shall be a tie and no account shall be taken of the number of wickets that have fallen.

16.3.2 No Result

See 16.1.3 above.

16.4 Prematurely Terminated Matches – Calculation of the Target Score**16.4.1 Interrupted Matches – Calculation of the Target Score**

16.4.1.1 If, due to suspension of play after the start of the match, the number of overs in the innings of either team has to be revised to a lesser number than originally allotted (minimum of 20 overs), then a revised target score (to win) should be set for the number of overs which the team batting second will have the opportunity of facing. This revised target is to be calculated using the current Duckworth/Lewis/Stern method. The target set will always be a whole number and one run less will constitute a Tie. (Refer Duckworth/Lewis/Stern Regulations).

16.4.2 Prematurely Terminated Matches

16.4.2.1 If the innings of the side batting second is suspended (with at least 20 overs bowled) and it is not possible for the match to be resumed, the match will be decided by comparison with the DLS 'Par Score' determined at the instant of the suspension by the Duckworth/Lewis/Stern method (refer Duckworth/Lewis/Stern Regulations). If the score is equal to the par score, the match is a Tie. Otherwise the result is a victory, or defeat, by the margin of runs by which the score exceeds, or falls short of, the Par Score.

16.5 Winning hit or extras

16.5.1 As soon as a result is reached as defined in clauses 16.1, 16.2 or 16.3.1, the match is at an end. Nothing that happens thereafter, except as in clause 41.18.2 (Penalty runs), shall be regarded as part of it. Note also clause 16.8.

16.5.2 The side batting last will have scored enough runs to win only if its total of runs is sufficient without including any runs completed by the batters before the completion of a catch, or the obstruction of a catch, from which the striker could be dismissed.

16.5.3 If a boundary is scored before the batters have completed sufficient runs to win the match, the whole of the boundary allowance shall be credited to the side's total and, in the case of a hit by the bat, to the striker's score.

16.6 Statement of result

If the side batting last wins the match without losing all its wickets, the result shall be stated as a win by the number of wickets still then to fall.

If, without having scored a total of runs in excess of the total scored by the opposing side, the innings of the side batting last has been completed, but as the result of an award of 5 Penalty runs its total of runs is then sufficient to win, the result shall be stated as a win to that side by Penalty runs.

If the side fielding last wins the match, the result shall be stated as a win by runs.

If the match is decided by one side conceding defeat or refusing to play, the result shall be stated as Match Conceded or Match Awarded, as the case may be.

16.7 Correctness of result

Any decision as to the correctness of the scores shall be the responsibility of the umpires. See clause 2.15 (Correctness of scores).

16.8 Mistakes in scoring

If, after the players and umpires have left the field in the belief that the match has been concluded, the umpires discover that a mistake in scoring has occurred which affects the result then, subject to clause 16.9, they shall adopt the following procedure.

16.8.1 If, when the players leave the field, the side batting last has not completed its innings and

either the number of overs to be bowled in that innings has not been completed, or

the end of the innings has not been reached,

then, unless one side concedes defeat, the umpires shall order play to resume.

Unless a result is reached sooner, play will then continue, if conditions permit, until the prescribed number of overs has been completed. The number of overs shall be taken as they were at the call of Time for the supposed conclusion of the match. No account shall be taken of the time between that moment and the resumption of play.

16.8.2 If, at this call of Time, the overs have been completed and no Playing time remains, or if the side batting last has completed its innings, the umpires shall immediately inform both captains of the necessary corrections to the scores and to the result.

16.9 Result not to be changed

Once the umpires have agreed with the scorers the correctness of the scores at the conclusion of the match – see clauses 2.15 (Correctness of scores) and 3.2 (Correctness of scores) – the result cannot thereafter be changed.

16.10 Event Format

The ICC Women's Championship will be contested by the following eight teams who have been seeded according to their positions at the ICC Women's World Cup 2017:

- England (1)
- India (2)
- Australia (3)
- South Africa (4)
- New Zealand (5)
- West Indies (6)
- Sri Lanka (7)
- Pakistan (8)

At the conclusion of the ICC Women's Championship, the host (New Zealand) plus the top three ranked teams (other than New Zealand) will automatically qualify for the ICC Women's World Cup 2021. The remaining four teams will take part in the ICC Women's World Cup 2021 Qualifier.

Each team will play one series against the other seven teams in a round-robin format. There shall be a maximum of four home series and a minimum of three home series per team.

Points will be allocated for each match in accordance with the system described in clause 16.10.1 of these playing conditions.

Following the completion of the round-robin matches, each team's position in the league table will represent its final event ranking.

16.10.1 Round-Robin Matches

The following points system shall apply:

Win	2
Tie, No Result or Abandoned.....	1
Loss.....	0

In the event of teams finishing on equal points at the end of the round-robin matches, the final event rankings will be decided in the following order of priority:

- The team with the most number of wins
- If still equal, the team with the highest net run rate in all round robin matches
- The team which has earned more points in the head to head matches
- If still equal, the team with the highest net run rate in the head to head matches

If the above does not resolve the final event rankings, or if all matches produce no results, then any tied teams will be ordered as per their original seeding as above.

Please note in a match declared as no result, run rate is not applicable.

16.10.2 Net Run Rate

A team's net run rate is calculated by deducting from the average runs per over scored by that team throughout the competition, the average runs per over scored against that team throughout the competition.

In the event of a team being all out in less than its full quota of overs, the calculation of its net run rate of both teams shall be based on the full quota of overs to which the batting team would have been entitled and not on the number of overs in which the team was dismissed.

Only those matches where results are achieved will count for the purpose of net run rate calculations. Where a match is abandoned, but a result is achieved under Duckworth/Lewis/Stern, for net run rate purposes Team 1 will be accredited with Team 2's Par Score on abandonment off the same number of overs faced by Team 2. Where a match is concluded but with Duckworth/Lewis/Stern having been applied at an earlier point in the match, Team 1 will be accredited with 1 run less than the final target score for Team 2 off the total number of overs allocated to Team 2 to reach the target.

In circumstances where a match (and the points for such match) is awarded to a team as a result of the other team's refusal to play, either by the ICC Match Referee in accordance with clause 16.2 or in accordance with the provisions of the relevant event agreements signed by the participating teams, the net run rate of the defaulting team shall be affected in that the full 50 overs of the defaulting team's innings in such forfeited match shall be taken into account in calculating the average runs per over of the defaulting team over the course of the league. For the avoidance of doubt the runs scored and overs bowled in such forfeited match will not be taken into account when calculating the net run rate of the team to whom the match was awarded.

In the event of any dispute the ICC Event Technical Committee may be called on to make a ruling and its ruling will be final.

17 THE OVER**17.1 Number of balls**

The ball shall be bowled from each end alternately in overs of 6 balls.

17.2 Start of an over

An over has started when the bowler starts her run-up or, if there is no run-up, starts her action for the first delivery of that over.

17.3 Validity of balls

17.3.1 A ball shall not count as one of the 6 balls of the over unless it is delivered, even though, as in clause 41.16 (Non-striker leaving her ground early) a batter may be dismissed or some other incident occurs without the ball having been delivered.

17.3.2 A ball delivered by the bowler shall not count as one of the 6 balls of the over

- 17.3.2.1 if it is called dead, or is to be considered dead, before the striker has had an opportunity to play it. See clause 20.6 (Dead ball; ball counting as one of over).
 - 17.3.2.2 if it is called dead in the circumstances of clause 20.4.2.6. Note also the special provisions of clause 20.4.2.5 (Umpire calling and signaling Dead ball).
 - 17.3.2.3 if it is a No ball. See clause 21 (No ball).
 - 17.3.2.4 if it is a Wide. See clause 22 (Wide ball).
 - 17.3.2.5 when any of clauses 24.4 (Player returning without permission), 28.2 (Fielding the ball), 41.4 (Deliberate attempt to distract striker), or 41.5 (Deliberate distraction, deception or obstruction of batter) is applied.
- 17.3.3 Any deliveries other than those listed in clauses 17.3.1 and 17.3.2 shall be known as valid balls. Only valid balls shall count towards the 6 balls of the over.

17.4 Call of Over

When 6 valid balls have been bowled and when the ball becomes dead, the umpire shall call Over before leaving the wicket. See also clause 20.3 (Call of Over or Time).

17.5 Umpire miscounting

- 17.5.1 If the umpire miscounts the number of valid balls, the over as counted by the umpire shall stand.
- 17.5.2 If, having miscounted, the umpire allows an over to continue after 6 valid balls have been bowled, he/she may subsequently call Over when the ball becomes dead after any delivery, even if that delivery is not a valid ball.
- 17.5.3 Whenever possible, the third umpire shall liaise with the scorers and if possible inform the on-field umpires if the over has been miscounted.

17.6 Bowler changing ends

A bowler shall be allowed to change ends as often as desired, provided she does not bowl two overs consecutively, nor bowl parts of each of two consecutive overs, in the same innings.

17.7 Finishing an over

- 17.7.1 Other than at the end of an innings, a bowler shall finish an over in progress unless incapacitated or suspended under these Playing Conditions.
- 17.7.2 If for any reason, other than the end of an innings, an over is left uncompleted at the start of an interval or interruption, it shall be completed on resumption of play.

17.8 Bowler incapacitated or suspended during an over

If for any reason a bowler is incapacitated while running up to deliver the first ball of an over, or is incapacitated or suspended during an over, the umpire shall call and signal Dead ball. Another bowler shall complete the over from the same end, provided that she does not bowl two overs consecutively, nor bowl parts of each of two consecutive overs, in that innings.

18 SCORING RUNS

18.1 A run

The score shall be reckoned by runs. A run is scored

- 18.1.1 so often as the batters, at any time while the ball is in play, have crossed and made good their ground from end to end.
- 18.1.2 when a boundary is scored. See clause 19 (Boundaries).
- 18.1.3 when Penalty runs are awarded. See clause 18.6.

18.2 Runs disallowed

Wherever in these Playing Conditions provision is made for the scoring of runs or awarding of penalties, such runs and penalties will be subject to any provisions that may be applicable for the disallowance of runs or for the non-award of penalties.

When runs are disallowed, the one run penalty for No ball or Wide shall stand and 5 run penalties shall be allowed, except for Penalty runs under clause 28.3 (Protective helmets belonging to the fielding side).

18.3 Short runs

- 18.3.1 A run is short if a batter fails to make good her ground in turning for a further run.
- 18.3.2 Although a short run shortens the succeeding one, the latter if completed shall not be regarded as short. A striker setting off for the first run from in front of the popping crease may do so also without penalty.

18.4 Unintentional short runs

Except in the circumstances of clause 18.5,

- 18.4.1 if either batter runs a short run, the umpire concerned shall, unless a boundary is scored, call and signal Short run as soon as the ball becomes dead and that run shall not be scored.
- 18.4.2 if, after either or both batters run short, a boundary is scored the umpire concerned shall disregard the short running and shall not call or signal Short run.
- 18.4.3 if both batters run short in one and the same run, this shall be regarded as only one short run.
- 18.4.4 if more than one run is short then, subject to clauses 18.4.2 and 18.4.3, all runs called as short shall not be scored.
- 18.4.5 if there has been more than one short run, the umpire shall inform the scorers as to the number of runs to be recorded.

18.5 Deliberate short runs

- 18.5.1 If either umpire considers that one or both batters deliberately ran short at that umpire's end, the umpire concerned shall, when the ball is dead, call and signal Short run and inform the other umpire of what has occurred and apply clause 18.5.2.
- 18.5.2 The bowler's end umpire shall
- disallow all runs to the batting side
 - return any not out batter to her original end
 - signal No ball or Wide to the scorers, if applicable
 - award 5 Penalty runs to the fielding side
 - award any other 5-run Penalty that is applicable except for Penalty runs under clause 28.3 (Protective helmets belonging to the fielding side)
 - inform the scorers as to the number of runs to be recorded, and
 - inform the captain of the fielding side and, as soon as practicable, the captain of the batting side of the reason for this action.

18.6 Runs awarded for penalties

Runs shall be awarded for penalties under clause 18.5 (Deliberate short runs), 21 (No ball), 22 (Wide ball), 24.4 (Player returning without permission), 26.4 (Penalties for contravention), 28.2 (Fielding the ball), 28.3 (Protective helmets belonging to the fielding side) 41 (Unfair play) and 42 (Players' conduct). Note, however, the restrictions on the award of Penalty runs in clauses 23.3 (Leg byes not to be awarded), 28.3 (Protective helmets belonging to the fielding side) and 34 (Hit the ball twice).

18.7 Runs scored for boundaries

Runs shall be scored for boundary allowances under clause 19 (Boundaries).

18.8 Runs scored when a batter is dismissed

When a batter is dismissed, any runs for penalties awarded to either side shall stand.

No other runs shall be credited to the batting side, except as follows.

- 18.8.1 If a batter is dismissed Obstructing the field, the batting side shall also score any runs completed before the offence.
- If, however, the obstruction prevented a catch being made, no runs other than penalties shall be scored.
- 18.8.2 If a batter is dismissed Run out, the batting side shall also score any runs completed before the wicket was put down.

18.9 Runs scored when the ball becomes dead other than at the fall of a wicket

When the ball becomes dead for any reason other than the fall of a wicket, or is called dead by an umpire, unless there is specific provision otherwise in these Playing Conditions, any runs for penalties awarded to either side shall be scored. Note however the provisions of clauses 23.3 (Leg byes not to be awarded) and 28.3 (Protective helmets belonging to the fielding side).

Additionally the batting side shall be credited with all runs completed by the batters before the incident or call of Dead ball and the run in progress if the batters had already crossed at the instant of the incident or call of Dead ball. Note specifically, however, the provisions of clause 41.5.8 (Deliberate distraction, deception or obstruction of batter).

18.10 Crediting of runs scored

Unless stated otherwise in these Playing Conditions,

- 18.10.1 if the ball is struck by the bat, all runs scored by the batting side shall be credited to the striker, except for the following:
- an award of 5 Penalty runs, which shall be scored as Penalty runs
 - the one run penalty for a No ball, which shall be scored as a No ball extra.
- 18.10.2 if the ball is not struck by the bat, runs shall be scored as Penalty runs, Byes, Leg byes, No ball extras or Wides as the case may be. If Byes or Leg byes accrue from a No ball, only the one run penalty for No ball shall be scored as such, and the remainder as Byes or Leg byes as appropriate.
- 18.10.3 the bowler shall be debited with:
- all runs scored by the striker
 - all runs scored as No ball extras
 - all runs scored as Wides.

18.11 Batter returning to original end

- 18.11.1 When the striker is dismissed in any of the circumstances in clauses 18.11.1.1 to 18.11.1.5, the not out batter shall return to her original end.
- 18.11.1.1 Bowled.
 - 18.11.1.2 Stumped.
 - 18.11.1.3 Hit the ball twice.
 - 18.11.1.4 LBW.
 - 18.11.1.5 Hit wicket.
- 18.11.2 The batters shall return to their original ends in any of the cases of clauses 18.11.2.1 to 18.11.2.3.
- 18.11.2.1 A boundary is scored.
 - 18.11.2.2 Runs are disallowed for any reason.
 - 18.11.2.3 A decision by the batters at the wicket to do so, under clause 41.5 (Deliberate distraction, deception or obstruction of batter).

18.12 Batter returning to wicket she has left

- 18.12.1 When a batter is dismissed in any of the ways in clauses 18.12.1.1 to 18.12.1.3, the not out batter shall return to the wicket she has left but only if the batters had not already crossed at the instant of the incident causing the dismissal. If runs are to be disallowed, however, the not out batter shall return to her original end.
- 18.12.1.1 Caught
- 18.12.1.2 Obstructing the field
- 18.12.1.3 Run out.
- 18.12.2 If, while a run is in progress, the ball becomes dead for any reason other than the dismissal of a batter, the batters shall return to the wickets they had left, but only if they had not already crossed in running when the ball became dead. If, however, any of the circumstances of clauses 18.11.2.1 to 18.11.2.3 apply, the batters shall return to their original ends.

19 BOUNDARIES**19.1 Determining the boundary of the field of play**

- 19.1.1 Before the toss, the umpires shall determine the boundary of the field of play, which shall be fixed for the duration of the match. See clause 2.3.4 (Consultation with Home Board).
- 19.1.2 The boundary shall be determined such that no part of any sight-screen, will, at any stage of the match, be within the field of play.
- 19.1.3 With respect to the size of the boundaries, no boundary shall be longer than 65 yards (59.43 metres), and no boundary should be shorter than 55 yards (50.29 metres) from the centre of the pitch to be used.
- 19.1.4 Any ground on which a Test or ODI International has been played prior to 1 October 2005 which cannot conform with these minimum dimensions shall be exempt from this playing condition. Any new ground must conform to these minimum dimensions.

19.2 Identifying and marking the boundary

- 19.2.1 All boundaries must be designated by a rope, or similar object of a minimum standard as authorised by the ICC from time to time. The rope should be positioned a required minimum distance (3 yards (2.74 metres) minimum) inside the perimeter fencing or advertising signs, or from any solid object located between the rope and the fence/signs. For grounds with a large playing area, the maximum length of boundary should be used before applying the minimum 3 yards (2.74 metres) between the boundary and the fence.
- 19.2.2 If the boundary is marked by means of an object that is in contact with the ground the boundary will be the edge of the grounded part of the object which is nearest the pitch.
- 19.2.3 An obstacle within the field of play shall not be regarded as a boundary unless so determined by the umpires before the toss. See clause 2.3.4 (Consultation with Home Board).

- 19.2.4 If an unauthorized person enters the playing arena and handles the ball, the umpire at the bowler's end shall be the sole judge of whether the boundary allowance should be scored or the ball be treated as still in play or called dead ball if a batter is liable to be out as a result of the unauthorized person handling the ball.

19.3 Restoring the boundary

If a solid object used to mark the boundary is disturbed for any reason, then:

- 19.3.1 the boundary shall be considered to be in its original position.
- 19.3.2 the object shall be returned to its original position as soon as is practicable; if play is taking place, this shall be as soon as the ball is dead.
- 19.3.3 if some part of a fence or other marker has come within the field of play, that part shall be removed from the field of play as soon as is practicable; if play is taking place, this shall be as soon as the ball is dead.

19.4 Ball grounded beyond the boundary

- 19.4.1 The ball in play is grounded beyond the boundary if it touches
- the boundary or any part of an object used to mark the boundary;
 - the ground beyond the boundary;
 - any object that is grounded beyond the boundary.
- 19.4.2 The ball in play is to be regarded as being grounded beyond the boundary if
- a fielder, grounded beyond the boundary as in clause 19.5, touches the ball;
 - a fielder, after catching the ball within the boundary, becomes grounded beyond the boundary while in contact with the ball, before completing the catch.

19.5 Fielder grounded beyond the boundary

- 19.5.1 A fielder is grounded beyond the boundary if some part of her person is in contact with any of the following:
- the boundary or any part of an object used to mark the boundary;
 - the ground beyond the boundary;
 - any object that is in contact with the ground beyond the boundary;
 - another fielder who is grounded beyond the boundary.
- 19.5.2 A fielder who is not in contact with the ground is considered to be grounded beyond the boundary if her final contact with the ground, before her first contact with the ball after it has been delivered by the bowler, was not entirely within the boundary.

19.6 Boundary allowances

- 19.6.1 6 runs shall be allowed for a boundary 6; and 4 runs for a boundary 4. See also clause 19.7.

19.7 Runs scored from boundaries

- 19.7.1 A boundary 6 will be scored if and only if the ball has been struck by the bat and is first grounded beyond the boundary without having been in contact with the ground within the field of play. This shall apply even if the ball has previously touched a fielder.
- 19.7.2 A boundary 4 will be scored when a ball that is grounded beyond the boundary
- whether struck by the bat or not, was first grounded within the boundary, or
 - has not been struck by the bat.
- 19.7.3 When a boundary is scored, the batting side, except in the circumstances of clause 19.8, shall be awarded whichever is the greater of
- 19.7.3.1 the allowance for the boundary
 - 19.7.3.2 the runs completed by the batters together with the run in progress if they had already crossed at the instant the boundary is scored.
- 19.7.4 When the runs in clause 19.7.3.2 exceed the boundary allowance they shall replace the boundary allowance for the purposes of clause 18.12.2.
- 19.7.5 The scoring of Penalty runs by either side is not affected by the scoring of a boundary.

19.8 Overthrow or wilful act of fielder

If the boundary results from an overthrow or from the wilful act of a fielder, the runs scored shall be

any runs for penalties awarded to either side

and the allowance for the boundary

and the runs completed by the batters, together with the run in progress if they had already crossed at the instant of the throw or act.

Clause 18.12.2 (Batter returning to wicket she has left) shall apply as from the instant of the throw or act.

20 DEAD BALL**20.1 Ball is dead**

- 20.1.1 The ball becomes dead when
- 20.1.1.1 it is finally settled in the hands of the wicket-keeper or of the bowler.
 - 20.1.1.2 a boundary is scored. See clause 19.7 (Runs scored from boundaries).

- 20.1.1.3 a batter is dismissed. The ball will be deemed to be dead from the instant of the incident causing the dismissal.
 - 20.1.1.4 whether played or not it becomes trapped between the bat and person of a batter or between items of her clothing or equipment.
 - 20.1.1.5 whether played or not it lodges in the clothing or equipment of a batter or the clothing of an umpire.
 - 20.1.1.6 there is an award of Penalty runs under either of clauses 24.4 (Player returning without permission) or 28.3 (Fielding the ball). The ball shall not count as one of the over.
 - 20.1.1.7 there is a contravention of clause 28.3 (Protective helmets belonging to the fielding side).
 - 20.1.1.8 the match is concluded in any of the ways stated in clause 12.6 (Conclusion of match).
- 20.1.2 The ball shall be considered to be dead when it is clear to the bowler's end umpire that the fielding side and both batters at the wicket have ceased to regard it as in play.
- 20.1.3 In a match where cameras are being used on or over the field of play (e.g. Spydercam), should a ball that has been hit by the batter make contact, while still in play, with the camera, its apparatus or its cable, either umpire shall call and signal 'dead ball'. The ball shall not count as one of the over and no runs shall be scored. If the delivery was called a No ball it shall count and the No ball penalty shall be applied. No other runs (including penalty runs) apart from the No ball penalty shall be scored.
- 20.1.4 Should a ball thrown by a fielder make contact with a camera on or over the field of play, its apparatus or its cable, either umpire shall call and signal dead ball. Unless this was already a No ball or Wide, the ball shall count as one of the over. All runs scored to that point shall count, plus the run in progress if the batters have already crossed.
- 20.1.5 Refer also to paragraph 2.6 of Appendix D.

20.2 Ball finally settled

Whether the ball is finally settled or not is a matter for the umpire alone to decide.

20.3 Call of Over or Time

Neither the call of Over (see clause 17.4), nor the call of Time (see clause 12.2) is to be made until the ball is dead, either under clauses 20.1 or 20.4.

20.4 Umpire calling and signalling Dead ball

- 20.4.1 When the ball has become dead under clause 20.1, the bowler's end umpire may call and signal Dead ball if it is necessary to inform the players.
- 20.4.2 Either umpire shall call and signal Dead ball when
 - 20.4.2.1 intervening in a case of unfair play.

- 20.4.2.2 a possibly serious injury to a player or umpire occurs.
- 20.4.2.3 leaving his/her normal position for consultation.
- 20.4.2.4 one or both bails fall from the striker's wicket before the striker has had the opportunity of playing the ball.
- 20.4.2.5 the striker is not ready for the delivery of the ball and, if the ball is delivered, makes no attempt to play it. Provided the umpire is satisfied that the striker had adequate reason for not being ready, the ball shall not count as one of the over.
- 20.4.2.6 the striker is distracted by any noise or movement or in any other way while preparing to receive, or receiving a delivery. This shall apply whether the source of the distraction is within the match or outside it. Note also clause 20.4.2.7. The ball shall not count as one of the over.
- 20.4.2.7 there is an instance of a deliberate attempt to distract under either of clauses 41.4 (Deliberate attempt to distract striker) or 41.5 (Deliberate distraction, deception or obstruction of batter). The ball shall not count as one of the over.
- 20.4.2.8 the bowler drops the ball accidentally before delivery.
- 20.4.2.9 the ball does not leave the bowler's hand for any reason other than an attempt to run out the non-striker under clause 41.16 (Non-striker leaving her ground early).
- 20.4.2.10 satisfied that the ball in play cannot be recovered.
- 20.4.2.11 required to do so under any of the Playing Conditions not included above.

20.5 Ball ceases to be dead

The ball ceases to be dead – that is, it comes into play – when the bowler starts her run-up or, if there is no run-up, starts her bowling action.

20.6 Dead ball; ball counting as one of over

- 20.6.1 When a ball which has been delivered is called dead or is to be considered dead then, other than as in clause 20.6.2,
 - 20.6.1.1 it will not count in the over if the striker has not had an opportunity to play it.
 - 20.6.1.2 Unless No ball or Wide ball has been called, it will be a valid ball if the striker has had an opportunity to play it, except in the circumstances of clauses 20.4.2.6 and 24.4 (Player returning without permission), 28.2 (Fielding the ball), 41.4 (Deliberate attempt to distract striker) and 41.5 (Deliberate distraction, deception or obstruction of batter).
- 20.6.2 In clause 20.4.2.5, the ball will not count in the over only if both conditions of not attempting to play the ball and having an adequate reason for not being ready are met. Otherwise the delivery will be a valid ball.

21 NO BALL

21.1 Mode of delivery

- 21.1.1 The umpire shall ascertain whether the bowler intends to bowl right handed or left handed, over or round the wicket, and shall so inform the striker.

It is unfair if the bowler fails to notify the umpire of a change in her mode of delivery. In this case the umpire shall call and signal No ball.
- 21.1.2 Underarm bowling shall not be permitted.

21.2 Fair delivery – the arm

For a delivery to be fair in respect of the arm the ball must not be delivered with an Illegal Bowling Action.

An Illegal Bowling Action is defined as a bowling action where a bowler's Elbow Extension exceeds 15 degrees, measured from the point at which the bowling arm reaches the horizontal until the point at which the ball is released (any Elbow Hyperextension shall be discounted for the purposes of determining an Illegal Bowling Action).

Should either umpire or the ICC Match Referee suspect that a bowler has used an Illegal Bowling Action, they shall complete the ICC Bowling Action Report Form at the conclusion of the match, as set out in the Illegal Bowling Regulations.

21.3 Ball thrown or delivered underarm – action by umpires

- 21.3.1 If, in the opinion of either umpire, the ball has been thrown (where such mode of delivery does not correspond to the bowler's normal bowling action) or delivered underarm, he/she shall call and signal No ball and, when the ball is dead, inform the other umpire of the reason for the call.

The bowler's end umpire shall then

- warn the bowler, indicating that this is a first and final warning. This warning shall apply to that bowler throughout the innings.
- inform the captain of the fielding side of the reason for this action.
- inform the batters at the wicket of what has occurred.

- 21.3.2 If either umpire considers that, in that innings, a further delivery by the same bowler is thrown (where such mode of delivery does not correspond to the bowler's normal bowling action) or delivered underarm, he/she shall call and signal No ball and when the ball is dead inform the other umpire of the reason for the call.

The bowler's end umpire shall then

- direct the captain of the fielding side to suspend the bowler immediately from bowling. The over shall, if applicable, be completed by another bowler, who shall neither have bowled the previous over or part thereof nor be allowed to bowl any part of the next over. The bowler thus suspended shall not bowl again in that innings.

- inform the batters at the wicket and, as soon as practicable, the captain of the batting side of the reason for this action.

21.3.3 The umpires together shall report the occurrence as soon as possible after the match to the ICC Match Referee, who shall take such action as is considered appropriate against the bowler concerned.

21.4 Bowler throwing towards striker's end before delivery

If the bowler throws the ball towards the striker's end before entering the delivery stride, either umpire shall call and signal No ball. See clause 41.17 (Batters stealing a run).

However, the procedure stated in clause 21.3 of caution, informing, final warning, action against the bowler and reporting shall not apply.

21.5 Fair delivery – the feet

For a delivery to be fair in respect of the feet, in the delivery stride

- 21.5.1 the bowler's back foot must land within and not touching the return crease appertaining to her stated mode of delivery.
- 21.5.2 the bowler's front foot must land with some part of the foot, whether grounded or raised
- on the same side of the imaginary line joining the two middle stumps as the return crease described in clause 21.5.1, and
 - behind the popping crease.

If the bowler's end umpire is satisfied that any of these three conditions have not been met, he/she shall call and signal No ball. See clause 41.8 (Bowling of deliberate front foot No ball).

21.6 Bowler breaking wicket in delivering ball

Either umpire shall call and signal No ball if, other than in an attempt to run out the non-striker under clause 41.16, the bowler breaks the wicket at any time after the ball comes into play and before completion of the stride after the delivery stride. This shall include any clothing or other object that falls from her person and breaks the wicket.

21.7 Ball bouncing more than once, rolling along the ground or pitching off the pitch

The umpire shall call and signal No ball if a ball which he/she considers to have been delivered, without having previously touched bat or person of the striker,

- bounces more than once
- or rolls along the ground before it reaches the popping crease.
- or pitches wholly or partially off the pitch as defined in clause 6.1 (Area of pitch) before it reaches the line of the striker's wicket.

21.8 Ball coming to rest in front of striker's wicket

If a ball delivered by the bowler comes to rest in front of the line of the striker's wicket, without having previously touched the bat or person of the striker, the umpire shall call and signal No ball and immediately call and signal Dead ball.

21.9 Fielder intercepting a delivery

If except in the circumstances of clause 27.3 (Position of wicket-keeper) a ball, delivered by the bowler, makes contact with any part of a fielder's person before it either makes contact with the striker's bat or person, or it passes the striker's wicket, the umpire shall call and signal No ball and immediately call and signal Dead ball.

21.10 Ball bouncing over head height of striker

See clauses 22.1.1.2 and 41.6.1.7.

21.11 Call of No ball for infringement of other Playing Conditions

In addition to the instances above, No ball is to be called and signalled as required by the following clauses:

Clause 27.3 – Position of wicket-keeper

Clause 28.4 – Limitation of on side fielders

Clause 28.5 – Fielders not to encroach on pitch

Clause 41.6 – Bowling of dangerous and unfair short pitched deliveries

Clause 41.7 – Bowling of dangerous and unfair non-pitching deliveries

Clause 41.8 – Bowling of deliberate front foot No ball.

21.12 Revoking a call of No ball

An umpire shall revoke the call of No ball if Dead ball is called under any of clauses 20.4.2.4 to 20.4.2.9 (Umpire calling and signaling Dead ball). However, if a no ball is called in breach of clause 20.4.2.7 (41.4 - Deliberate attempt to distract striker before playing the ball or 41.5 - Deliberate attempt of Distraction, Deception or Obstruction of striker after the stroke) the No ball will stand.

21.13 No ball to over-ride Wide

A call of No ball shall over-ride the call of Wide ball at any time. See clauses 22.1 (Judging a Wide) and 22.2 (Call and signal of Wide ball).

21.14 Ball not dead

The ball does not become dead on the call of No ball.

21.15 Penalty for a No ball

A penalty of one run shall be awarded instantly on the call of No ball. Unless the call is revoked, the penalty shall stand even if a batter is dismissed. It shall be in addition to any other runs scored, any boundary allowance and any other runs awarded for penalties.

21.16 Runs resulting from a No ball – how scored

The one run penalty shall be scored as a No ball extra and shall be debited against the bowler. If other Penalty runs have been awarded to either side these shall be scored as stated in clause 41.18 (Penalty runs). Any runs completed by the batters or any boundary allowance shall be credited to the striker if the ball has been struck by the bat; otherwise they shall also be scored as Byes or Leg byes as appropriate.

21.17 No ball not to count

A No ball shall not count as one of the over. See clause 17.3 (Validity of balls).

21.18 Out from a No ball

When No ball has been called, neither batter shall be out under any of the Playing Conditions except clause 34 (Hit the ball twice), clause 37 (Obstructing the field) or clause 38 (Run out).

21.19 Free Hit

- 21.19.1 In addition to the above, the delivery following a No ball called (all modes of No ball) shall be a free hit for whichever batter is facing it. If the delivery for the free hit is not a legitimate delivery (any kind of No ball or a Wide ball) then the next delivery will become a free hit for whichever batter is facing it.
- 21.19.2 For any free hit, the striker can be dismissed only under the circumstances that apply for a No ball, even if the delivery for the free hit is called Wide ball.
- 21.19.3 Neither field changes nor the exchange of individuals between fielding positions are permitted for free hit deliveries unless:
- 21.19.3.1 There is a change of striker (the provisions of clause 41.2 shall apply), or
- 21.19.3.2 The No Ball was the result of a fielding restriction breach, in which case the field may be changed to the extent of correcting the breach.
- 21.19.4 For clarity, the bowler can change her mode of delivery for the free hit delivery. In such circumstances clause 21.1 shall apply.
- 21.19.5 The umpires will signal a free hit by (after the normal No Ball signal) extending one arm straight upwards and moving it in a circular motion.

22 WIDE BALL**22.1 Judging a Wide**

- 22.1.1 If the bowler bowls a ball, not being a No ball, the umpire shall adjudge it a Wide if, according to the definition in clause 22.1.2
- 22.1.1.1 the ball passes wide of where the striker is standing and which also would have passed wide of the striker standing in a normal guard position.
- 22.1.1.2 the ball passes above the head height of the striker standing upright at the popping crease.
- 22.1.2 The ball will be considered as passing wide of the striker unless it is sufficiently within reach for her to be able to hit it with the bat by means of a normal cricket stroke.
- 22.1.3 Umpires are instructed to apply very strict and consistent interpretation in regard to this clause in order to prevent negative bowling wide of the wicket.

22.2 Call and signal of Wide ball

If the umpire adjudges a delivery to be a Wide he/she shall call and signal Wide ball as soon as the ball passes the striker's wicket. It shall, however, be considered to have been a Wide from the instant that the bowler entered her delivery stride, even though it cannot be called Wide until it passes the striker's wicket.

22.3 Revoking a call of Wide ball

- 22.3.1 The umpire shall revoke the call of Wide ball if there is then any contact between the ball and the striker's bat or person before the ball comes into contact with any fielder.
- 22.3.2 The umpire shall revoke the call of Wide ball if a delivery is called a No ball. See clause 21.13 (No ball to over-ride Wide).

22.4 Delivery not a Wide

- 22.4.1 The umpire shall not adjudge a delivery as being a Wide, if the striker, by moving, either causes the ball to pass wide of her, as defined in clause 22.1.2 or brings the ball sufficiently within reach to be able to hit it by means of a normal cricket stroke.
- 22.4.2 The umpire shall not adjudge a delivery as being a Wide if the ball touches the striker's bat or person, but only as the ball passes the striker.

22.5 Ball not dead

The ball does not become dead on the call of Wide ball.

22.6 Penalty for a Wide

A penalty of one run shall be awarded instantly on the call of Wide ball. Unless the call is revoked, see clause 22.3, this penalty shall stand even if a batter is dismissed, and shall be in addition to any other runs scored, any boundary allowance and any other runs awarded for penalties.

22.7 Runs resulting from a Wide – how scored

All runs completed by the batters or a boundary allowance, together with the penalty for the Wide, shall be scored as Wide balls. Apart from any award of 5 Penalty runs, all runs resulting from a Wide shall be debited against the bowler.

22.8 Wide not to count

A Wide shall not count as one of the over. See clause 17.3 (Validity of balls).

22.9 Out from a Wide

When Wide ball has been called, neither batter shall be out under any of the Playing Conditions except clause 35 (Hit wicket), clause 37 (Obstructing the field), clause 38 (Run out) or clause 39 (Stumped).

23 BYE AND LEG BYE**23.1 Byes**

If the ball, delivered by the bowler, not being a Wide, passes the striker without touching her bat or person, any runs completed by the batters from that delivery, or a boundary allowance, shall be credited as Byes to the batting side. Additionally, if the delivery is a No ball, the one run penalty for such a delivery shall be incurred.

23.2 Leg byes

23.2.1 If a ball delivered by the bowler first strikes the person of the striker, runs shall be scored only if the umpire is satisfied that the striker has

either attempted to play the ball with the bat; or
tried to avoid being hit by the ball.

23.2.2 If the umpire is satisfied that either of these conditions has been met runs shall be scored as follows.

23.2.2.1 If there is

either no subsequent contact with the striker's bat or person, or

only inadvertent contact with the striker's bat or person
any runs completed by the batters or a boundary allowance shall be credited to the striker in the case of subsequent contact with her bat but otherwise to the batting side as in clause 23.2.3.

23.2.2.2 If the striker wilfully makes a lawful second strike, clause 34.3 (Ball lawfully struck more than once) and clause 34.4 (Runs permitted from ball lawfully struck more than once) shall apply.

23.2.3 The runs in clause 23.2.2.1, unless credited to the striker, shall be scored as Leg byes.

Additionally, if the delivery is a No ball, the one run penalty for the No ball shall be incurred.

23.3 Leg byes not to be awarded

If in the circumstance of clause 23.2.1 the umpire considers that neither of the conditions therein has been met, then Leg byes shall not be awarded.

If the ball does not become dead for any other reason, the umpire shall call and signal Dead ball as soon as the ball reaches the boundary or at the completion of the first run.

The umpire shall then:

- disallow all runs to the batting side;
- return any not out batter to her original end;
- signal No ball to the scorers if applicable;
- award any 5-run Penalty that is applicable except for Penalty runs under clause 28.3 (Protective helmets belonging to the fielding side).

24 FIELDER'S ABSENCE; SUBSTITUTES**24.1 Substitute fielders**

24.1.1 The umpires shall allow a substitute fielder

24.1.1.1 if they are satisfied that a fielder has been injured or become ill and that this occurred during the match, or

24.1.1.2 for any other wholly acceptable reason.

In all other circumstances, a substitute is not allowed.

24.1.2 A substitute shall not bowl or act as captain but may act as wicket-keeper only with the consent of the umpires. Note, however, clause 42.4.1.

24.1.3 A nominated player may bowl or field even though a substitute has previously acted for her, subject to 24.2 and 24.3.

24.1.4 Squad members of the fielding or batting team who are not playing in the match and who are not acting as substitute fielders shall be required to wear a team training bib whilst on the playing area (including the area between the boundary and the perimeter fencing).

24.2 Fielder absent or leaving the field of play

24.2.1 A player going briefly outside the boundary while carrying out any duties as a fielder is not absent from the field of play nor, for the purposes of this clause, is she to be regarded as having left the field of play.

24.2.2 If a fielder fails to take the field at the start of play or at any later time, or leaves the field during play,

24.2.2.1 an umpire shall be informed of the reason for this absence.

24.2.2.2 she shall not thereafter come on to the field of play during a session of play without the consent of the umpire. See clause 24.4. The umpire shall give such consent as soon as it is practicable.

24.2.3 If a player is absent from the field for longer than 8 minutes, the following restrictions shall apply to their future participation in the match:

24.2.3.1 The player shall not be permitted to bowl in the match until she has either been able to field, or her team has subsequently been batting, for the total length of playing time for which the player was absent (hereafter referred to as Penalty time). A player's unexpired Penalty time shall be limited to a maximum of 110 minutes. If any unexpired Penalty time remains at the end of an innings, it is carried forward to the next and subsequent innings of the match.

- 24.2.3.2 The player shall not be permitted to bat in the match until her team's batting innings has been in progress for the length of playing time that is equal to the unexpired Penalty time carried forward from the previous innings. However, once her side has lost five wickets in its batting innings, she may bat immediately. If any unexpired penalty time remains at the end of that batting innings, it is carried forward to the next and subsequent innings of the match.
- 24.2.4 If the player leaves the field before having served all of her Penalty time, the balance is carried forward as unserved Penalty time.
- 24.2.5 On any occasion of absence, the amount of playing time for which the player is off the field shall be added to any Penalty time that remains unserved, subject to a maximum cumulative Penalty time of 110 minutes, and that player shall not bowl until all of her Penalty time has been served.
- 24.2.6 For the purposes of clauses 24.2.3.1 and 24.2.3.2, playing time shall comprise the time play is in progress excluding intervals, intervals between innings and official drinks intervals. For clarity, a player's Penalty time will continue to expire after she is dismissed, for the remainder of her team's batting innings.
- 24.2.7 If there is an unscheduled break in play, the stoppage time shall count as Penalty time served, provided that,
- 24.2.7.1 the fielder who was on the field of play at the start of the break either takes the field on the resumption of play, or her side is now batting.
- 24.2.7.2 the fielder who was already off the field at the start of the break notifies an umpire in person as soon as she is able to participate, and either takes the field on the resumption of play, or her side is now batting. Stoppage time before an umpire has been so notified shall not count towards unserved Penalty time.
- 24.2.8 Any unserved Penalty time shall be carried forward into the next innings of the match, as applicable.
- 24.3 Penalty time not incurred**
- A nominated player's absence will not incur Penalty time if,
- 24.3.1 she has suffered an external blow during the match and, as a result, has justifiably left the field or is unable to take the field.
- 24.3.2 in the opinion of the umpires, the player has been absent or has left the field for other wholly acceptable reasons, which shall not include illness or internal injury.
- 24.3.3 the player is absent from the field for a period of 8 minutes or less.

24.4 Player returning without permission

If a player comes on to the field of play in contravention of clause 24.2.2 and comes into contact with the ball while it is in play, the ball shall immediately become dead.

- The umpire shall award 5 Penalty runs to the batting side.
- Runs completed by the batters shall be scored together with the run in progress if they had already crossed at the instant of the offence.
- The ball shall not count as one of the over.
- The umpire shall inform the other umpire, the captain of the fielding side, the batters and, as soon as practicable, the captain of the batting side of the reason for this action.

25 BATTER'S INNINGS**25.1 Eligibility to act as a batter**

Only a nominated player may bat and, subject to clause 25.3, may do so even though a substitute fielder has previously acted for her.

25.2 Commencement of a batter's innings

The innings of the first two batters, and that of any new batter on the resumption of play after a call of Time, shall commence at the call of Play. At any other time, a batter's innings shall be considered to have commenced when that batter first steps onto the field of play.

25.3 Restriction on batter commencing an innings

- 25.3.1 If a member of the batting side has unserved Penalty time, see clause 24.2.7, that player shall not be permitted to bat until that Penalty time has been served. However, even if the unserved Penalty time has not expired, that player may bat after her side has lost 5 wickets.
- 25.3.2 A member of the batting side's Penalty time is served during Playing time, in the event of an unscheduled stoppage, the stoppage time after the batter notifies an umpire in person that she is able to participate shall count as Penalty time served.
- 25.3.3 If any unserved Penalty time remains at the end of a team's innings, it shall be carried forward to the next innings of the match if appropriate.

25.4 Batter retiring

- 25.4.1 A batter may retire at any time during her innings when the ball is dead. The umpires, before allowing play to proceed, shall be informed of the reason for a batter retiring.
- 25.4.2 If a batter retires because of illness, injury or any other unavoidable cause, that batter is entitled to resume her innings. If for any reason this does not happen, that batter is to be recorded as 'Retired – not out'.
- 25.4.3 If a batter retires for any reason other than as in clause 25.4.2, the innings of that batter may be resumed only with the consent of the opposing captain. If for any reason her innings is not resumed, that batter is to be recorded as 'Retired – out'.

- 25.4.4 If after retiring a batter resumes her innings, subject to the requirements of clauses 25.4.2 and 25.4.3, it shall be only at the fall of a wicket or the retirement of another batter.

25.5 Runners

Runners shall not be permitted.

26 PRACTICE ON THE FIELD

26.1 Practice on the pitch or the rest of the square

- 26.1.1 There shall not be any practice on the pitch at any time.
- 26.1.2 There shall not be any practice on the rest of the square at any time except with the approval of the umpires.
- 26.1.2.1 If approved by the umpires, the use of the square for practice on any day of any match will be restricted to any netted practice area or bowling strips specifically prepared on the edge of the square for that purpose.
- 26.1.2.2 Bowling practice on the bowling strips referred to above shall also be permitted during the interval (and change of innings if not the interval) unless the umpires consider that, in the prevailing conditions of ground and weather, it will be detrimental to the surface of the square.

26.2 Practice on the outfield

- 26.2.1 On any day of the match, all forms of practice are permitted on the outfield
- before the start of play
 - after the close of play, and
 - during the interval or between innings
- providing the umpires are satisfied that such practice will not cause significant deterioration in the condition of the outfield.
- 26.2.2 Between the call of Play and the call of Time, practice shall be permitted on the outfield, providing that all of the following conditions are met:
- only the fielders as defined in paragraph 7 of Appendix A participate in such practice.
 - no ball other than the match ball is used for this practice.
 - no bowling practice takes place in the area between the square and the boundary in a direction parallel to the match pitch.
 - the umpires are satisfied that it will not contravene either of clauses 41.3 (The match ball changing its condition) or 41.9 (Time wasting by the fielding side).
- Bowling a ball, using a short run up to a player in the outfield is not to be regarded as bowling practice but shall be subject to the other conditions in this clause.

26.3 Trial run-up

A bowler is permitted to have a trial run-up provided the umpire is satisfied that it will not contravene either of clauses 41.9 (Time wasting by the fielding side) or 41.12 (Fielder damaging the pitch).

26.4 Penalties for contravention

All forms of practice are subject to the provisions of clauses 41.3 (The match ball – changing its condition), 41.9 (Time wasting by the fielding side) and 41.12 (Fielder damaging the pitch).

- 26.4.1 If there is a contravention of any of the provisions of clause 26.1 or 26.2, the umpire shall
- warn the player that the practice is not permitted;
 - inform the other umpire and, as soon as practicable, both captains of the reason for this action.
- 26.4.1.1 If the contravention is by a batter at the wicket, the umpire shall inform the other batter and each incoming batter that the warning has been issued. The warning shall apply to the team of that player throughout the match.
- 26.4.2 If during the match there is any further contravention by any player of that team, the umpire shall
- award 5 Penalty runs to the opposing side;
 - inform the other umpire, the scorers and, as soon as practicable, both captains, and, if the contravention is during play, the batters at the wicket.

27 THE WICKET-KEEPER

27.1 Protective equipment

The wicket-keeper is the only fielder permitted to wear gloves and external leg guards. If these are worn, they are to be regarded as part of her person for the purposes of clause 28.2 (Fielding the ball). If by the wicket-keeper's actions and positioning when the ball comes into play it is apparent to the umpires that she will not be able to carry out the normal duties of a wicket-keeper, she shall forfeit this right and also the right to be recognised as a wicket-keeper for the purposes of clauses 33.2 (A fair catch), 39 (Stumped), 28.1 (Protective equipment), 28.4 (Limitation of on-side fielders) and 28.5 (Fielders not to encroach on pitch).

27.2 Gloves

- 27.2.1 If, as permitted under clause 27.1, the wicket-keeper wears gloves, they shall have no webbing between the fingers except joining index finger and thumb, where webbing may be inserted as a means of support.
- 27.2.2 If used, the webbing shall be a single piece of non-stretch material which, although it may have facing material attached, shall have no reinforcements or tucks.

- 27.2.3 The top edge of the webbing shall not protrude beyond the straight line joining the top of the index finger to the top of the thumb and shall be taut when a hand wearing the glove has the thumb fully extended. See paragraph 3 of Appendix B.

27.3 Position of wicket-keeper

- 27.3.1 The wicket-keeper shall remain wholly behind the wicket at the striker's end from the moment the ball comes into play until a ball delivered by the bowler touches the bat or person of the striker, or passes the wicket at the striker's end, or the striker attempts a run.
- 27.3.2 In the event of the wicket-keeper contravening this clause, the striker's end umpire shall call and signal No ball as soon as applicable after the delivery of the ball.

27.4 Movement by wicket-keeper

- 27.4.1 After the ball comes into play and before it reaches the striker, it is unfair if the wicket-keeper significantly alters her position in relation to the striker's wicket, except for the following:
- 27.4.1.1 movement of a few paces forward for a slower delivery, unless in so doing it brings her within reach of the wicket.
- 27.4.1.2 lateral movement in response to the direction in which the ball has been delivered.
- 27.4.1.3 movement in response to the stroke that the striker is playing or that her actions suggest she intends to play. However the provisions of clause 27.3 shall apply.
- 27.4.2 In the event of unfair movement by the wicket-keeper, either umpire shall call and signal Dead ball.

27.5 Restriction on actions of wicket-keeper

If, in the opinion of either umpire, the wicket-keeper interferes with the striker's right to play the ball and to guard her wicket, clause 20.4.2.6 (Umpire calling and signalling Dead ball) shall apply.

If, however, either umpire considers that the interference by the wicket-keeper was wilful, then clause 41.4 (Deliberate attempt to distract striker) shall also apply.

27.6 Interference with wicket-keeper by striker

If, in playing at the ball or in the legitimate defence of her wicket, the striker interferes with the wicket-keeper, she shall not be out except as provided for in clause 37.3 (Obstructing a ball from being caught).

28 THE FIELDER

28.1 Protective equipment

No fielder other than the wicket-keeper shall be permitted to wear gloves or external leg guards. In addition, protection for the hand or fingers may be worn only with the consent of the umpires.

28.2 Fielding the ball

- 28.2.1 A fielder may field the ball with any part of her person (see paragraph 12 of Appendix A), except as in clause 28.2.1.2. However, she will be deemed to have fielded the ball illegally if, while the ball is in play she wilfully
- 28.2.1.1 uses anything other than part of her person to field the ball.
- 28.2.1.2 extends her clothing with her hands and uses this to field the ball.
- 28.2.1.3 discards a piece of clothing, equipment or any other object which subsequently makes contact with the ball.
- 28.2.2 It is not illegal fielding if the ball in play makes contact with a piece of clothing, equipment or any other object which has accidentally fallen from the fielder's person.
- 28.2.3 If a fielder illegally fields the ball, the ball shall immediately become dead and
- the penalty for a No ball or a Wide shall stand.
 - any runs completed by the batters shall be credited to the batting side, together with the run in progress if the batters had already crossed at the instant of the offence.
 - the ball shall not count as one of the over.
- In addition the umpire shall:
- award 5 Penalty runs to the batting side.
 - inform the other umpire and the captain of the fielding side of the reason for this action.
 - inform the batters and, as soon as practicable, the captain of the batting side of what has occurred.

28.3 Protective helmets belonging to the fielding side

- 28.3.1 Protective helmets, when not in use by fielders, may not be placed on the ground, above the surface except behind the wicket-keeper and in line with both sets of stumps.
- 28.3.2 If the ball while in play strikes a helmet, placed as described in clause 28.3.1,
- 28.3.2.1 the ball shall become dead and, subject to clause 28.3.3,
- 28.3.2.2 an award of 5 Penalty runs shall be made to the batting side;

28.3.2.3 any runs completed by the batters before the ball strikes the protective helmet shall be scored, together with the run in progress if the batters had already crossed at the instant of the ball striking the protective helmet.

28.3.3 If the ball while in play strikes a helmet, placed as described in clause 28.3.1, unless the circumstances of clause 23.3 (Leg byes not to be awarded) or clause 34 (Hit the ball twice), apply, the umpire shall:

- permit the batters's runs as in clause 28.3.2.3 to be scored
- signal No ball or Wide ball to the scorers if applicable
- award 5 Penalty runs as in clause 28.3.2.2
- award any other Penalty runs due to the batting side.

28.3.4 If the ball while in play strikes a helmet, placed as described in clause 28.3.1, and the circumstances of clause 23.3 (Leg byes not to be awarded) or clause 34 (Hit the ball twice) apply, the umpire shall:

- disallow all runs to the batting side
- return any not out batter to her original end
- signal No ball or Wide ball to the scorers if applicable
- award any 5-run Penalty that is applicable except for Penalty runs under clause 28.3.2.

28.4 Limitation of on side fielders

- 28.4.1 At the instant of delivery, there may not be more than 5 fielders on the leg side.
- 28.4.2 At the instant of the bowler's delivery there shall not be more than two fielders, other than the wicket-keeper, behind the popping crease on the on side. A fielder will be considered to be behind the popping crease unless the whole of her person whether grounded or in the air is in front of this line.
- 28.4.3 In the event of infringement of this clause by any fielder, the striker's end umpire shall call and signal No ball.

28.5 Fielders not to encroach on pitch

While the ball is in play and until the ball has made contact with the striker's bat or person, or has passed the striker's bat, no fielder, other than the bowler, may have any part of her person grounded on or extended over the pitch.

In the event of infringement of this clause by any fielder other than the wicket-keeper, the bowler's end umpire shall call and signal No ball as soon as possible after delivery of the ball. Note, however, clause 27.3 (Position of wicket-keeper).

28.6 Movement by any fielder other than the wicket-keeper

- 28.6.1 Any movement by any fielder, excluding the wicket-keeper, after the ball comes into play and before the ball reaches the striker, is unfair except for the following:
- 28.6.1.1 minor adjustments to stance or position in relation to the striker's wicket.
- 28.6.1.2 movement by any fielder, other than a close fielder, towards the striker or the striker's wicket that does not significantly alter the position of the fielder.
- 28.6.1.3 movement by any fielder in response to the stroke that the striker is playing or that her actions suggest she intends to play.
- 28.6.2 In all circumstances clause 28.4 (Limitation of on side fielders) shall apply.
- 28.6.3 In the event of such unfair movement, either umpire shall call and signal Dead ball.
- 28.6.4 Note also the provisions of clause 41.4 (Deliberate attempt to distract striker). See also clause 27.4 (Movement by wicket-keeper).

28.7 Restrictions on the placement of fielders

- 28.7.1 In addition to the restrictions contained in clause 28.4 above, further fielding restrictions shall apply to certain overs in each innings. The nature of such fielding restrictions and the overs during which they shall apply are set out in the following paragraphs.
- 28.7.2 The following fielding restrictions shall apply:
- 28.7.2.1 Two semi-circles shall be drawn on the field of play. The semi-circles shall have as their centre the middle stump at either end of the pitch. The radius of each of the semi-circles shall be 25.15 yards (23 metres). The semi-circles shall be linked by two parallel straight lines drawn on the field. (Refer to paragraph 2 of Appendix C). The fielding restriction areas should be marked by continuous painted white lines or 'dots' at 5 yard (4.57 metres) intervals, each 'dot' to be covered by a white plastic or rubber (but not metal) disc measuring 7 inches (18 cm) in diameter.
- 28.7.2.2 Subject to the provisions of 28.7.2.4 below, the Powerplay Overs shall apply for 15 overs per innings to be taken as follows:
- 28.7.2.2.1 Powerplay 1 – (block of 10 overs for an uninterrupted match) no more than two (2) fielders shall be permitted outside this fielding restriction area. In an innings of 50 overs, these are overs 1 to 10 inclusive.

- 28.7.2.2.2 Powerplay 2 – (block of 5 overs for an uninterrupted match) no more than three (3) fielders shall be permitted outside this fielding restriction area. It shall be taken at the discretion of either of the batters at the wicket.
- 28.7.2.2.3 In an innings of scheduled duration of between 41 and 50 overs, it may not be completed later than the 40th over. (No equivalent restriction applies to innings of shorter scheduled duration.)
- 28.7.2.2.4 A batter must nominate her team's Powerplay no later than the moment at which the umpire reaches the stumps at the bowler's end for the start of the next over.
- 28.7.2.2.5 Once a batter has nominated a Powerplay, the decision cannot be reversed.
- 28.7.2.2.6 Should the batting side choose not to exercise their discretion, their Powerplay Overs will automatically commence at the latest available point in the innings (e.g. in a 50 over innings with one unclaimed Powerplay, this will begin at the start of the 36th over).
- 28.7.2.3 During non Powerplay overs, no more than four (4) fielders shall be permitted outside this fielding restriction area.
- 28.7.2.4 In circumstances when the number of overs of the batting team is reduced, the number of overs within each phase of the innings shall be reduced in accordance with the table below. For the sake of clarity, it should be noted that the table shall apply to both the 1st and 2nd innings of the match.

INNINGS DURATION	POWER PLAY 1	POWER PLAY 2	POWER PLAY 2
20 – 21	4	2	6
22 – 24	5	2	7
25 – 28	5	3	8
29 – 31	6	3	9
32 – 34	7	3	10
35 – 38	7	4	11
39 – 41	8	4	12
42 – 44	9	4	13
45 – 48	9	5	14
49	10	5	15

- 28.7.2.5 Each block of Powerplay Overs must commence at the start of an over.

Illustrations:

- a) If play is interrupted during an innings and the table above applies, the Powerplay takes immediate effect. For the avoidance of doubt this applies even if the interruption has occurred mid-over.

A match starts as 50 overs, is interrupted after 12 overs and reduced to 43 overs. (The first 10 overs have been Powerplays (PP); the next two were not.) The new PP allocation is 9+4, so there are 3 overs left for the batting side. These must start no later than the 38th over in order to be completed by the 40th over.

- b) If play is interrupted during the first Powerplay and on resumption the overs required to be bowled in that Powerplay have already been exceeded, then the second Powerplay will be assumed to have been taken immediately and will continue until it is completed.

A 50 over innings is interrupted after 9.3 overs, and on resumption has been reduced to 43 overs. Powerplay overs are 9+4. 2nd Powerplay is in progress with 0.3 out of the 4 overs completed, i.e. it covers overs 10 to 13. The fielding restrictions relating to the second Powerplay take immediate effect on resumption.

- c) If following an interruption, on resumption the total number of Powerplay Overs for the innings has already been exceeded, then there will be no further Powerplay deliveries bowled in the innings. Note that this is the only circumstance under which the Powerplay status can be changed during an over.

A 45 over innings is interrupted after 8.3 overs, and on resumption has been reduced to 28 overs. Powerplay overs are 5+3. All Powerplay overs have been completed. Non-Powerplay restrictions take effect immediately and do not need to wait until the end of the over.

- d) If following an interruption while a Powerplay is not in progress, it is found on resumption that the recalculated number of Powerplay Overs remaining exceeds the number of overs to be bowled in the innings, then the Powerplays will commence at the start of the next over, with fewer than the scheduled number of Powerplay Overs being bowled in the innings.

- A 41 over innings in which only the 1st Powerplay has been taken is interrupted after 35.1 overs and reduced to 39 overs. Powerplay overs are still 8+4. Powerplays automatically resume for the start of the next over, but only 11 of the 12 scheduled Powerplay overs can be bowled in the innings.
- e) If following an interruption while a Powerplay is not in progress, it is found on resumption that the recalculated number of Powerplay overs remaining exceeds the number of overs to be bowled in the innings, then the Powerplays will commence at the start of the next over, with fewer than the scheduled number of Powerplay overs being bowled in the innings.
- A 50 over innings in which only the 1st Powerplay has been taken is interrupted after 29.1 overs and reduced to 32 overs. Powerplay overs are 7+3+3. Powerplays automatically resume for the start of the next over, but only 12 of the 13 scheduled Powerplay overs can be bowled in the innings.
- 28.7.2.6 At the commencement of the second block of Powerplay overs, the umpire shall signal such commencement to the scorers by rotating his/her arm in a large circle.
- 28.7.2.7 The scoreboard shall indicate the whenever Powerplay overs are being bowled, along with the number of overs remaining in the current block of Powerplay overs.
- 28.7.2.8 In the event of an infringement of any of the above fielding restrictions, the square leg umpire shall call and signal 'No Ball'.

29 THE WICKET IS DOWN

29.1 Wicket put down

- 29.1.1 The wicket is put down if a bail is completely removed from the top of the stumps, or a stump is struck out of the ground,
- 29.1.1.1 by the ball,
- 29.1.1.2 by the striker's bat if held or by any part of the bat that she is holding,
- 29.1.1.3 for the purpose of this clause only, by the striker's bat not in hand, or by any part of the bat which has become detached,
- 29.1.1.4 by the striker's person or by any part of her clothing or equipment becoming detached from her person,
- 29.1.1.5 by a fielder with her hand or arm, providing that the ball is held in the hand or hands so used, or in the hand of the arm so used.

- 29.1.1.6 The wicket is also put down if a fielder strikes or pulls a stump out of the ground as clause 29.1.1.5.
- 29.1.2 The disturbance of a bail, whether temporary or not, shall not constitute its complete removal from the top of the stumps, but if a bail in falling lodges between two of the stumps this shall be regarded as complete removal.

29.2 One bail off

If one bail is off, it shall be sufficient for the purpose of putting the wicket down to remove the remaining bail or to strike or pull any of the three stumps out of the ground, in any of the ways stated in clause 29.1.

29.3 Remaking wicket

If a wicket is broken or put down while the ball is in play, it shall not be remade by an umpire until the ball is dead. See clause 20 (Dead ball). Any fielder may, however, while the ball is in play,

- replace a bail or bails on top of the stumps.
- put back one or more stumps into the ground where the wicket originally stood.

29.4 Dispensing with bails

If the umpires have agreed to dispense with bails in accordance with clause 8.4 (Dispensing with bails), it is for the umpire concerned to decide whether or not the wicket has been put down.

- 29.4.1 After a decision to play without bails, the wicket has been put down if the umpire concerned is satisfied that the wicket has been struck by the ball, by the striker's bat, person or items of her clothing or equipment as described in clauses 29.1.1.2, 29.1.1.3 or 29.1.1.4, or by a fielder in the manner described in clause 29.1.1.5.
- 29.4.2 If the wicket has already been broken or put down, clause 29.4.1 shall apply to any stump or stumps still in the ground. Any fielder may replace a stump or stumps, in accordance with clause 29.3, in order to have an opportunity of putting the wicket down.

30 BATTER OUT OF HER GROUND

30.1 When out of her ground

- 30.1.1 A batter shall be considered to be out of her ground unless some part of her person or bat is grounded behind the popping crease at that end.
- 30.1.2 However, a batter shall not be considered to be out of her ground if, in running or diving towards her ground and beyond, and having grounded some part of her person or bat beyond the popping crease, there is subsequent loss of contact between the ground and any part of her person or bat, or between the bat and person.

30.2 Which is a batter's ground

- 30.2.1 If only one batter is within a ground, it is her ground and will remain so even if she is later joined there by the other batter.
- 30.2.2 If both batters are in the same ground and one of them subsequently leaves it, the ground belongs to the batter who remains in it.
- 30.2.3 If there is no batter in either ground, then each ground belongs to whichever batter is nearer to it, or, if the batters are level, to whichever batter was nearer to it immediately prior to their drawing level.
- 30.2.4 If a ground belongs to one batter then the other ground belongs to the other batter, irrespective of her position.

30.3 Position of non-striker

The non-striker, when standing at the bowler's end, should be positioned on the opposite side of the wicket to that from which the ball is being delivered, unless a request to do otherwise is granted by the umpire.

31 APPEALS**31.1 Umpire not to give batter out without an appeal**

Neither umpire shall give a batter out, even though she may be out under these Playing Conditions, unless appealed to by a fielder. This shall not debar a batter who is out under these Playing Conditions from leaving the wicket without an appeal having been made. Note, however, the provisions of clause 31.7.

31.2 Batter dismissed

A batter is dismissed if she is either given out by an umpire, on appeal or out under these Playing Conditions and leaves the wicket as in clause 31.1.

31.3 Timing of appeals

For an appeal to be valid, it must be made before the bowler begins her run-up or, if there is no run-up, her bowling action to deliver the next ball, and before Time has been called.

The call of Over does not invalidate an appeal made prior to the start of the following over, provided Time has not been called. See clauses 12.2 (Call of Time) and 17.2 (Start of an over).

31.4 Appeal "How's That?"

An appeal "How's That?" covers all ways of being out.

31.5 Answering appeals

The striker's end umpire shall answer all appeals arising out of any of clauses 35 (Hit wicket), 39 (Stumped) or 38 (Run out) when this occurs at the wicket-keeper's end. The bowler's end umpire shall answer all other appeals.

When an appeal is made, each umpire shall answer on any matter that falls within his/her jurisdiction.

When a batter has been given Not out, either umpire may answer an appeal, made in accordance with clause 31.3, if it is on a further matter and is within his/her jurisdiction.

31.6 Consultation by umpires

Each umpire shall answer appeals on matters within his/her own jurisdiction. If an umpire is doubtful about any point that the other umpire may have been in a better position to see, he/she shall consult the latter on this point of fact and shall then give the decision. If, after consultation, there is still doubt remaining, the decision shall be Not out.

31.7 Batter leaving the wicket under a misapprehension

An umpire shall intervene if satisfied that a batter, not having been given out, has left the wicket under a misapprehension of being out. The umpire intervening shall call and signal Dead ball to prevent any further action by the fielding side and shall recall the batter.

A batter may be recalled at any time up to the instant when the ball comes into play for the next delivery, unless it is the final wicket of the innings, in which case it should be up to the instant when the umpires leave the field.

31.8 Withdrawal of an appeal

The captain of the fielding side may withdraw an appeal only after obtaining the consent of the umpire within whose jurisdiction the appeal falls. If such consent is given, the umpire concerned shall, if applicable, revoke the decision and recall the batter.

The withdrawal of an appeal must be before the instant when the ball comes into play for the next delivery or, if the innings has been completed, the instant when the umpires leave the field.

32 BOWLED**32.1 Out Bowled**

32.1.1 The striker is out Bowled if her wicket is put down by a ball delivered by the bowler, not being a No ball, even if it first touches the striker's bat or person.

32.1.2 However, the striker shall not be out Bowled if before striking the wicket the ball has been in contact with any other player or an umpire. The striker will, however, be subject to clauses 37 (Obstructing the field), 38 (Run out) and 39 (Stumped).

32.2 Bowled to take precedence

The striker is out Bowled if her wicket is put down as in clause 32.1, even though a decision against her for any other method of dismissal would be justified.

33 CAUGHT**33.1 Out Caught**

The striker is out Caught if a ball delivered by the bowler, not being a No ball, touches her bat without having previously been in contact with any fielder, and is subsequently held by a fielder as a fair catch, as described in clauses 33.2 and 33.3, before it touches the ground.

33.2 A fair catch

33.2.1 A catch will be fair only if, in every case

either the ball, at any time

or any fielder in contact with the ball,

is not grounded beyond the boundary before the catch is completed. Note clauses 19.4 (Ball grounded beyond the boundary) and 19.5 (Fielder grounded beyond the boundary).

33.2.2 Furthermore, a catch will be fair if any of the following conditions applies:

33.2.2.1 the ball is held in the hand or hands of a fielder, even if the hand holding the ball is touching the ground, or is hugged to the body, or lodges in the external protective equipment worn by a fielder, or lodges accidentally in a fielder's clothing.

33.2.2.2 a fielder catches the ball after it has been lawfully struck more than once by the striker, but only if it has not been grounded since it was first struck. See clause 34 (Hit the ball twice).

33.2.2.3 a fielder catches the ball after it has touched the wicket, an umpire, another fielder or the other batter.

33.2.2.4 a fielder catches the ball after it has crossed the boundary in the air, provided that the conditions in clause 33.2.1 are met.

33.2.2.5 the ball is caught off an obstruction within the boundary that is not designated a boundary by the umpires.

33.3 Making a catch

The act of making a catch shall start from the time when the ball first comes into contact with a fielder's person and shall end when a fielder obtains complete control over both the ball and her own movement.

33.4 No runs to be scored

If the striker is dismissed Caught, runs from that delivery completed by the batters before the completion of the catch shall not be scored but any runs for penalties awarded to either side shall stand. Clause 18.12 (Batter returning to the wicket she has left) shall apply from the instant of the completion of the catch.

33.5 Caught to take precedence

If the criteria of clause 33.1 are met and the striker is not out Bowled, then she is out Caught, even though a decision against either batter for another method of dismissal would be justified.

34 HIT THE BALL TWICE**34.1 Out Hit the ball twice**

34.1.1 The striker is out Hit the ball twice if, while the ball is in play, it strikes any part of her person or is struck by her bat and, before the ball has been touched by a fielder, the striker wilfully strikes it again with her bat or person, other than a hand not holding the bat, except for the sole purpose of guarding her wicket. See clause 34.3 and clause 37 (Obstructing the field).

34.1.2 For the purpose of this clause 'struck' or 'strike' shall include contact with the person of the striker.

34.2 Not out Hit the ball twice

The striker will not be out under this clause if she

34.2.1 strikes the ball a second or subsequent time in order to return the ball to any fielder.

Note, however, the provisions of clause 37.4 (Returning the ball to a fielder).

34.2.2 wilfully strikes the ball after it has touched a fielder. Note, however the provisions of clause 37.1 (Out Obstructing the field).

34.3 Ball lawfully struck more than once

The striker may, solely in order to guard her wicket and before the ball has been touched by a fielder, lawfully strike the ball a second or subsequent time with the bat, or with any part of her person other than a hand not holding the bat. The striker may guard her wicket even if the delivery is a No ball.

However, the striker may not prevent the ball from being caught by striking the ball more than once in defence of her wicket. See clause 37.3 (Obstructing a ball from being caught).

34.4 Runs permitted from ball lawfully struck more than once

When the ball is lawfully struck more than once, as permitted in clause 34.3, if the ball does not become dead for any reason, the umpire shall call and signal Dead ball as soon as the ball reaches the boundary or at the completion of the first run. However, the umpire shall delay the call of Dead ball to allow the opportunity for a catch to be completed.

The umpire shall

- disallow all runs to the batting side
- return any not out batter to her original end
- signal No ball to the scorers if applicable, and
- award any 5-run Penalty that is applicable except for Penalty runs under clause 28.3 (Protective helmets belonging to the fielding side).

34.5 Bowler does not get credit

The bowler does not get credit for the wicket.

35 HIT WICKET**35.1 Out Hit wicket**

- 35.1.1 The striker is out Hit wicket if, after the bowler has entered the delivery stride and while the ball is in play, her wicket is put down by either the striker's bat or person as described in clauses 29.1.1.2 to 29.1.1.4 (Wicket put down) in any of the following circumstances:
- 35.1.1.1 in the course of any action taken by her in preparing to receive or in receiving a delivery,
 - 35.1.1.2 in setting off for the first run immediately after playing or playing at the ball,
 - 35.1.1.3 if no attempt is made to play the ball, in setting off for the first run, providing that in the opinion of the umpire this is immediately after the striker has had the opportunity of playing the ball,
 - 35.1.1.4 in lawfully making a second or further stroke for the purpose of guarding her wicket within the provisions of clause 34.3 (Ball lawfully struck more than once).
- 35.1.2 If the striker puts her wicket down in any of the ways described in clauses 29.1.1.2 to 29.1.1.4 before the bowler has entered the delivery stride, either umpire shall call and signal Dead ball.

35.2 Not out Hit wicket

The striker is not out under this clause should her wicket be put down in any of the ways referred to in clause 35.1 if any of the following applies:

- it occurs after the striker has completed any action in receiving the delivery, other than in clauses 35.1.1.2 to 35.1.1.4.
- it occurs when the striker is in the act of running, other than setting off immediately for the first run.
- it occurs when the striker is trying to avoid being run out or stumped.
- it occurs when the striker is trying to avoid a throw in at any time.
- the bowler after entering the delivery stride does not deliver the ball. In this case either umpire shall immediately call and signal Dead ball. See clause 20.4 (Umpire calling and signalling Dead ball).
- the delivery is a No ball.

36 LEG BEFORE WICKET**36.1 Out LBW**

The striker is out LBW if all the circumstances set out in clauses 36.1.1 to 36.1.5 apply.

- 36.1.1 The bowler delivers a ball, not being a No ball
- 36.1.2 the ball, if it is not intercepted full-pitch, pitches in line between wicket and wicket or on the off side of the striker's wicket

- 36.1.3 the ball not having previously touched her bat, the striker intercepts the ball, either full-pitch or after pitching, with any part of her person
- 36.1.4 the point of impact, even if above the level of the bails, either is between wicket and wicket or if the striker has made no genuine attempt to play the ball with the bat, is between wicket and wicket or outside the line of the off stump.
- 36.1.5 but for the interception, the ball would have hit the wicket.

36.2 Interception of the ball

- 36.2.1 In assessing points of impact in clauses 36.1.3, 36.1.4 and 36.1.5, only the first interception is to be considered.
- 36.2.2 In assessing clause 36.1.3, if the bowler's end umpire is not satisfied that the ball intercepted the batter's person before it touched the bat, the batter shall be given Not out.
- 36.2.3 In assessing clause 36.1.5, it is to be assumed that the path of the ball before interception would have continued after interception, irrespective of whether the ball might have pitched subsequently or not.

36.3 Off side of wicket

The off side of the striker's wicket shall be determined by the striker's stance at the moment the ball comes into play for that delivery. See paragraph 13 of Appendix A.

37 OBSTRUCTING THE FIELD**37.1 Out Obstructing the field**

- 37.1.1 Either batter is out Obstructing the field if, except in the circumstances of clause 37.2, and while the ball is in play, she wilfully attempts to obstruct or distract the fielding side by word or action. See also clause 34 (Hit the ball twice).
- 37.1.2 The striker is out Obstructing the field if, except in the circumstances of clause 37.2, in the act of receiving a ball delivered by the bowler, she wilfully strikes the ball with a hand not holding the bat. This will apply whether it is the first strike or a second or subsequent strike. The act of receiving the ball shall extend both to playing at the ball and to striking the ball more than once in defence of her wicket.
- 37.1.3 This clause will apply whether or not No ball is called.
- 37.1.4 For the avoidance of doubt, if an umpire feels that a batter, in running between the wickets, has significantly changed her direction without probable cause and thereby obstructed a fielder's attempt to effect a run out, the batter should, on appeal, be given out, obstructing the field. It shall not be relevant whether a run out would have occurred or not.

If the change of direction involves the batter crossing the pitch, clause 41.14 shall also apply.

See also paragraph 2.2 of Appendix D.

37.2 Not out Obstructing the field

A batter shall not be out Obstructing the field if

obstruction or distraction is accidental, or

obstruction is in order to avoid injury, or

in the case of the striker, she makes a second or subsequent strike to guard her wicket lawfully as in clause 34.3 (Ball lawfully struck more than once). However, see clause 37.3.

37.3 Obstructing a ball from being caught

37.3.1 If the delivery is not a No ball, the striker is out Obstructing the field if wilful obstruction or distraction by either batter prevents the striker being out caught .

37.3.2 Clause 37.3.1 shall apply even if an obstruction is caused by the striker in lawfully guarding her wicket under the provision of Clause 34.3 (Ball lawfully struck more than once).

37.3.3 If an obstruction or distraction takes place from a No ball then the batter who caused the obstruction or distraction will be out Obstructing the field.

37.3.4 Clause 37.3.3 shall not apply if the striker obstructs while instinctively defending her wicket with a lawful second strike

37.4 Returning the ball to a fielder

Either batter is out Obstructing the field if, at any time while the ball is in play and, without the consent of a fielder, she uses the bat or any part of her person to return the ball to any fielder.

37.5 Runs scored

When either batter is dismissed Obstructing the field,

37.5.1 unless the obstruction prevents a catch from being made, any runs completed by the batters before the offence shall be scored, together with any runs awarded for penalties to either side. See clauses 18.6 (Runs awarded for penalties) and 18.8 (Runs scored when a batter is dismissed).

37.5.2 if the obstruction prevents a catch from being made, any runs completed by the batters shall not be scored but any penalties awarded to either side shall stand.

37.6 Bowler does not get credit

The bowler does not get credit for the wicket.

38 RUN OUT**38.1 Out Run out**

Either batter is out Run out, except as in clause 38.2, if, at any time while the ball is in play,

she is out of her ground

and her wicket is fairly put down by the action of a fielder

even though No ball has been called, except in the circumstances of clause 38.2.2.2, and whether or not a run is being attempted.

38.2 Batter not out Run out

38.2.1 A batter is not out Run out in the circumstances of clauses 38.2.1.1 or 38.2.1.2.

38.2.1.1 She has been within her ground and has subsequently left it to avoid injury, when the wicket is put down.

Note also the provisions of clause 30.1.2 (When out of her ground).

38.2.1.2 The ball delivered by the bowler has not made contact with a fielder, before the wicket is put down.

38.2.2 The striker is not out Run out in any of the circumstances in clauses 38.2.2.1 and 38.2.2.2.

38.2.2.1 She is out Stumped. See clause 39.1.2 (Out Stumped).

38.2.2.2 No ball has been called and she is out of her ground not attempting a run and the wicket is fairly put down by the wicket-keeper without the intervention of another fielder.

38.3 Which batter is out

The batter out in the circumstances of clause 38.1 is the one whose ground is at the end where the wicket is put down. See clause 30.2 (Which is a batter's ground).

38.4 Runs scored

If either batter is dismissed Run out, the run in progress when the wicket is put down shall not be scored, but any runs completed by the batters shall stand, together with any runs for penalties awarded to either side. See clauses 18.6 (Runs awarded for penalties) and 18.8 (Runs scored when a batter is dismissed).

38.5 Bowler does not get credit

The bowler does not get credit for the wicket.

39 STUMPED**39.1 Out Stumped**

- 39.1.1 The striker is out Stumped, except as in clause 39.3, if a ball which is delivered is not called No ball and she is out of her ground, other than as in clause 39.3.1 and she has not attempted a run when her wicket is fairly put down by the wicket-keeper without the intervention of another fielder. Note, however clause 27.3 (Position of wicket-keeper).
- 39.1.2 The striker is out Stumped if all the conditions of clause 39.1.1 are satisfied, even though a decision of Run out would be justified.

39.2 Ball rebounding from wicket-keeper's person

If the wicket is put down by the ball, it shall be regarded as having been put down by the wicket-keeper if the ball rebounds on to the stumps from any part of the wicket-keeper's person or equipment or has been kicked or thrown on to the stumps by the wicket-keeper.

39.3 Not out Stumped

- 39.3.1 The striker will not be out Stumped if, after having received the delivery, she has left her ground in order to avoid injury.
- 39.3.2 If the striker is not out Stumped she may, except in the circumstances of clause 38.2.2.2 (Batter not out run out) be out Run out if the conditions of clause 38.1 (Out Run out) apply.

40 TIMED OUT**40.1 Out Timed out**

- 40.1.1 After the fall of a wicket or the retirement of a batter, the incoming batter must, unless Time has been called, be in position to take guard or for the other batter to be ready to receive the next ball within 3 minutes of the dismissal or retirement. If this requirement is not met, the incoming batter will be out, Timed out.
- 40.1.2 In the event of an extended delay in which no batter comes to the wicket, the umpires shall adopt the procedure of clause 16.2 (ICC Match Referee awarding a match). For the purposes of that clause the start of the action shall be taken as the expiry of the 3 minutes referred to above.

40.2 Bowler does not get credit

The bowler does not get credit for the wicket.

41 UNFAIR PLAY**41.1 Fair and unfair play – responsibility of captains**

The captains are responsible for ensuring that play is conducted within the Spirit of Cricket, as well as within these Playing Conditions.

41.2 Fair and unfair play – responsibility of umpires

41.2.1 The umpires shall be the sole judges of fair and unfair play. If either umpire considers that any action by a player, not covered by these Playing Conditions, is unfair, he/she shall call and signal Dead ball, if appropriate, as soon as it becomes clear that the call will not disadvantage the non-offending side, and report the matter to the other umpire.

41.2.1.1 If this is a first offence by that side, the bowler's end umpire shall then

- summon the offending player's captain and issue a first and final warning which shall apply to all members of the team for the remainder of the match.
- warn the offending player's captain that any further such offence by any member of her team shall result in the award of 5 Penalty runs to the opposing team.

41.2.1.2 If this is a second or subsequent offence by that side the bowler's end umpire shall then

- summon the offending player's captain and inform her that there has been a further such offence.
- award 5 Penalty runs to the opposing side.

41.2.1.3 The umpires shall may then report the matter to the ICC Match Referee who shall take such action as is considered appropriate against the player concerned.

41.3 The match ball – changing its condition

41.3.1 The umpires shall make frequent and irregular inspections of the ball. In addition, they shall immediately inspect the ball if they suspect anyone of attempting to change the condition of the ball, except as permitted in clause 41.3.2.

41.3.2 It is an offence for any player to take any action which changes the condition of the ball.

Except in carrying out her normal duties, a batter is not allowed to wilfully damage the ball other than, when the ball is in play, in striking it with the bat. See also clause 5.5 (Damage to the ball).

- A fielder may, however:
- 41.3.2.1 polish the ball on her clothing provided that no artificial substance is used and that such polishing wastes no time.
- 41.3.2.2 remove mud from the ball under the supervision of an umpire.
- 41.3.2.3 dry a wet ball on a piece of cloth that has been approved by the umpires.
- 41.3.3 The umpires shall consider the condition of the ball to have been unfairly changed if any action by any player does not comply with the conditions in clause 41.3.2.
- 41.3.4 If the umpires together agree that the condition of the ball has been unfairly changed by a member or members of either side, or that its condition is inconsistent with the use it has received, they shall consider that there has been a contravention of this clause and decide together whether they can identify the player(s) responsible for such conduct.
- 41.3.5 If it is possible to identify the player(s) responsible for changing the condition of the ball, the umpires shall;
- 41.3.5.1 Change the ball forthwith.
- 41.3.5.1.1 If the umpires together agree that the condition of the ball has been unfairly changed by a member or members of the fielding side, the batter at the wicket shall choose the replacement ball from a selection of six other balls of various degrees of usage (including a new ball) and of the same brand as the ball in use prior to the contravention.
- 41.3.5.1.2 If the umpires together agree that the condition of the ball has been unfairly changed by a member or members of the batting side, the umpires shall select and bring into use immediately, a ball which shall have wear comparable to that of the previous ball immediately prior to the contravention.
- 41.3.5.2 Additionally, the bowler's end umpire shall
- award 5 Penalty runs to the opposing side.
 - if appropriate, inform the batters at the wicket and the captain of the fielding side that the ball has been changed and the reason for their action.
 - inform the captain of the batting side as soon as practicable of what has occurred.
- The umpires shall then report the matter to the ICC Match Referee who shall take such action as is considered appropriate against the player(s) concerned.

- 41.3.6 If it is not possible to identify the player(s) responsible for changing the condition of the ball, the umpires shall;
- 41.3.6.1 Change the ball forthwith. The umpires shall choose the replacement ball for one of similar wear and of the same brand as the ball in use prior to the contravention.
- 41.3.6.2 The bowler's end umpire shall issue the captain with a first and final warning, and
- 41.3.6.3 Advise the captain that should there be any further instances of changing the condition of the ball by that team during the remainder of the series, clause 41.3.5.2 above will be adopted, with the captain deemed to be the player responsible for the contravention.

41.4 Deliberate attempt to distract striker

- 41.4.1 It is unfair for any fielder deliberately to attempt to distract the striker while she is preparing to receive or receiving a delivery.
- 41.4.2 If either umpire considers that any action by a fielder is such an attempt, he/she shall immediately call and signal Dead ball and inform the other umpire of the reason for the call. The bowler's end umpire shall
- award 5 Penalty runs to the batting side.
 - inform the captain of the fielding side, the batters and, as soon as practicable, the captain of the batting side of the reason for the action.
- Neither batter shall be dismissed from that delivery and the ball shall not count as one of the over.
- The umpires may then report the matter to the ICC Match Referee who shall take such action as is considered appropriate against the fielder concerned.

41.5 Deliberate distraction, deception or obstruction of batter

- 41.5.1 In addition to clause 41.4, it is unfair for any fielder wilfully to attempt, by word or action, to distract, deceive or obstruct either batter after the striker has received the ball.
- 41.5.2 It is for either one of the umpires to decide whether any distraction, deception or obstruction is wilful or not.
- 41.5.3 If either umpire considers that a fielder has caused or attempted to cause such a distraction, deception or obstruction, he/she shall immediately call and signal Dead ball and inform the other umpire of the reason for the call.
- 41.5.4 Neither batter shall be dismissed from that delivery.

- 41.5.5 If an obstruction involves physical contact, the umpires together shall decide whether or not an offence under clause 42 (Players' conduct) has been committed.
- 41.5.5.1 If an offence under clause 42 (Players' conduct) has been committed, they shall apply the relevant procedures in clause 42 and shall also apply each of clauses 41.5.7 to 41.5.9.
- 41.5.5.2 If they consider that there has been no offence under clause 42 (Players' conduct), they shall apply each of clauses 41.5.6 to 41.5.10.
- 41.5.6 The bowler's end umpire shall;
- award 5 Penalty runs to the batting side.
 - inform the captain of the fielding side of the reason for this action and as soon as practicable inform the captain of the batting side.
- 41.5.7 The ball shall not count as one of the over.
- 41.5.8 Any runs completed by the batters before the offence shall be scored, together with any runs for penalties awarded to either side. Additionally, the run in progress shall be scored whether or not the batters had already crossed at the instant of the offence.
- 41.5.9 The batters at the wicket shall decide which of them is to face the next delivery.
- 41.5.10 The umpires may then report the matter to the ICC Match Referee who shall take such action as is considered appropriate against the fielder concerned.

41.6 Bowling of dangerous and unfair short pitched deliveries

- 41.6.1 Notwithstanding clause 41.6.2, the bowling of short pitched deliveries is dangerous if the bowler's end umpire considers that, taking into consideration the skill of the striker, by their speed, length, height and direction they are likely to inflict physical injury on her. The fact that the striker is wearing protective equipment shall be disregarded.
- In the first instance the umpire decides that the bowling of short pitched deliveries has become dangerous under 41.6.1
- 41.6.1.1 The umpire shall call and signal No ball, and when the ball is dead, caution the bowler and inform the other umpire, the captain of the fielding side and the batters of what has occurred. This caution shall apply to that bowler throughout the innings.
- 41.6.1.2 If there is a second instance, the umpire shall repeat the above procedure and indicate to the bowler that this is a final warning, which shall apply to that bowler throughout the innings.

- 41.6.13 Should there be any further instance by the same bowler in that innings, the umpire shall
- call and signal No ball
 - when the ball is dead, direct the captain of the fielding side to suspend the bowler immediately from bowling
 - inform the other umpire for the reason for this action.
- The bowler thus suspended shall not be allowed to bowl again in that innings.
- If applicable, the over shall be completed by another bowler, who shall neither have bowled any part of the previous over, nor be allowed to bowl any part of the next over.
- The umpire shall report the occurrence to the batters and, as soon as practicable, to the captain of the batting side.
- The umpires may then report the matter to the ICC Match Referee who shall take such action as is considered appropriate against the bowler concerned.
- 41.6.14 A bowler shall be limited to two fast short-pitched deliveries per over.
- 41.6.15 A fast short-pitched delivery is defined as a ball, which passes or would have passed above the shoulder height of the striker standing upright at the popping crease.
- 41.6.16 The umpire at the bowler's end shall advise the bowler and the batter on strike when each fast short pitched delivery has been bowled.
- 41.6.17 In addition, a ball that passes above head height of the batter, standing upright at the popping crease, that prevents her from being able to hit it with her bat by means of a normal cricket stroke shall be called a Wide. See also clause 22.1.1.2
- 41.6.17.1 For the avoidance of doubt any fast short pitched delivery that is called a Wide under this playing condition shall also count as one of the allowable short pitched deliveries in that over.
- 41.6.18 In the event of a bowler bowling more than two fast short-pitched deliveries in an over as defined in clause 41.6.15 above, the umpire at the bowler's end shall call and signal No ball on each occasion. A differential signal shall be used to signify a fast short pitched delivery. The umpire shall call and signal 'No ball' and then tap the head with the other hand.

- 41.6.1.9 If a bowler delivers a third fast short pitched ball in an over, the umpire, after the call of No ball and when the ball is dead, shall caution the bowler, inform the other umpire, the captain of the fielding side and the batters at the wicket of what has occurred. This caution shall apply throughout the innings.
- 41.6.1.10 If there is a second instance of the bowler being No balled in the innings for bowling more than two fast short pitched deliveries in an over, the umpire shall advise the bowler that this is her final warning for the innings.
- 41.6.1.11 Should there be any further instance by the same bowler in that innings, the umpire shall
- call and signal No ball
 - when the ball is dead, direct the captain of the fielding side to suspend the bowler immediately from bowling
 - inform the other umpire for the reason for this action.
- The bowler thus suspended shall not be allowed to bowl again in that innings.
- If applicable, the over shall be completed by another bowler, who shall neither have bowled any part of the previous over, nor be allowed to bowl any part of the next over.
- The umpire shall report the occurrence to the batters and, as soon as practicable, to the captain of the batting side.
- The umpires may then report the matter to the ICC Match Referee who shall take such action as is considered appropriate against the bowler concerned.
- 41.6.2 Should the umpires initiate the caution and warning procedures set out in clauses 41.6.1.3 and 41.7 such cautions and warnings are not to be cumulative.

41.7 Bowling of dangerous and unfair non-pitching deliveries

- 41.7.1 Any delivery, which passes or would have passed, without pitching, above waist height of the striker standing upright at the popping crease, is to be deemed to be unfair, whether or not it is likely to inflict physical injury on the striker. If the bowler bowls such a delivery the umpire shall immediately call and signal No ball.
- If, in the opinion of the umpire, such a delivery is considered likely to inflict physical injury on the batter by its speed and direction, it shall be considered dangerous. When the ball is dead the umpire shall caution the bowler, indicating that this is a first and final warning. The umpire shall also inform the other umpire, the captain of the fielding side and the batters of what has occurred. This caution shall apply to that bowler throughout the innings.

- 41.7.2 Should there be any further instance (where a dangerous non-pitching delivery is bowled and is considered likely to inflict physical injury on the batter) by the same bowler in that innings, the umpire shall
- call and signal No ball
 - when the ball is dead, direct the captain of the fielding side to suspend the bowler immediately from bowling
 - inform the other umpire for the reason for this action.
- The bowler thus suspended shall not be allowed to bowl again in that innings.
- If applicable, the over shall be completed by another bowler, who shall neither have bowled any part of the previous over, nor be allowed to bowl any part of the next over.
- Additionally the umpire shall
- report the occurrence to the batters and, as soon as practicable, to the captain of the batting side.
- The umpires may then report the matter to the ICC Match Referee who shall take such action as is considered appropriate against the bowler concerned.
- 41.7.3 The warning sequence in clauses 41.7.1 and 41.7.2 is independent of the warning and action sequence in clause 41.6.
- 41.7.4 If the umpire considers that a bowler deliberately bowled a high full-pitched delivery, deemed to be dangerous and unfair as defined in clause 41.7.1, then the caution and warning in clause 41.7.1 shall be dispensed with. The umpire shall
- immediately call and signal No ball.
 - when the ball is dead, direct the captain of the fielding side to suspend the bowler immediately from bowling and inform the other umpire for the reason for this action.
- The bowler thus suspended shall not be allowed to bowl again in that innings.
- If applicable, the over shall be completed by another bowler, who shall neither have bowled any part of the previous over, nor be allowed to bowl any part of the next over.
- report the occurrence to the batters and, as soon as practicable, to the captain of the batting side.
- The umpires together shall report the occurrence to the ICC Match Referee who shall take such action as is considered appropriate against the bowler concerned.

41.8 Bowling of deliberate front-foot No ball

If the umpire considers that the bowler has delivered a deliberate front-foot No ball, he/she shall

- immediately call and signal No ball.
- when the ball is dead, direct the captain of the fielding side to suspend the bowler immediately from bowling.
- inform the other umpire for the reason for this action.

The bowler thus suspended shall not be allowed to bowl again in that innings.

If applicable, the over shall be completed by another bowler, who shall neither have bowled any part of the previous over, nor be allowed to bowl any part of the next over.

- report the occurrence to the batters and, as soon as practicable, to the captain of the batting side.

The umpires together shall report the occurrence to the ICC Match Referee who shall take such action as is considered appropriate against the bowler concerned.

41.9 Time wasting by the fielding side

41.9.1 It is unfair for any fielder to waste time.

41.9.2 If either umpire considers that the progress of an over is unnecessarily slow, or time is being wasted in any other way, by the captain of the fielding side or by any other fielder, at the first instance the umpire concerned shall

- if the ball is in play, call and signal Dead ball.
- inform the other umpire of what has occurred.

The bowler's end umpire shall then

- warn the captain of the fielding side, indicating that this is a first and final warning.
- inform the batters of what has occurred.

41.9.3 If either umpire considers that there is any further waste of time in that innings by any fielder, the umpire concerned shall

- if the ball is in play, call and signal Dead ball.
- inform the other umpire of what has occurred.

The bowler's end umpire shall then award 5 Penalty runs to the batting side and inform the captain of the fielding side of the reason for this action.

Additionally the umpire shall inform the batters and, as soon as is practicable, the captain of the batting side of what has occurred.

If the umpires believe that the act of time wasting was deliberate or repetitive, they may lodge a report under the Code of Conduct. In such circumstances the Captain and/or any individual members of the fielding team responsible for the time wasting will be charged.

41.10 Batter wasting time

41.10.1 It is unfair for a batter to waste time. In normal circumstances, the striker should always be ready to take strike when the bowler is ready to start her run-up.

In addition, an incoming batter should be in position to take guard or her partner ready to receive the next ball within 2 minutes of the fall of the previous wicket.

41.10.2 Should either batter waste time by failing to meet this requirement, or in any other way, the following procedure shall be adopted. At the first instance, either before the bowler starts her run-up or when the ball becomes dead, as appropriate, the umpire shall

- warn both batters and indicate that this is a first and final warning. This warning shall apply throughout the innings. The umpire shall so inform each incoming batter.
- inform the other umpire of what has occurred.
- inform the captain of the fielding side and, as soon as practicable, the captain of the batting side of what has occurred.

41.10.3 If there is any further time wasting by any batter in that innings, the umpire shall, at the appropriate time while the ball is dead

- award 5 Penalty runs to the fielding side.
- inform the other umpire of the reason for this action.
- inform the other batter, the captain of the fielding side and, as soon as practicable, the captain of the batting side of what has occurred.

If the umpires believe that the act of time wasting was deemed to be deliberate or repetitive, they may lodge a report under the Code of Conduct. In such circumstances the batter concerned will be charged.

41.11 The protected area

The protected area is defined as that area of the pitch contained within a rectangle bounded at each end by imaginary lines parallel to the popping creases and 5 ft/1.52 m in front of each, and on the sides by imaginary lines, one each side of the imaginary line joining the centres of the two middle stumps, each parallel to it and 1 ft/30.48 cm from it.

41.12 Fielder damaging the pitch

41.12.1 It is unfair to cause deliberate or avoidable damage to the pitch. A fielder will be deemed to be causing avoidable damage if either umpire considers that her presence on the pitch is without reasonable cause.

41.12.2 If a fielder causes avoidable damage to the pitch, other than as in clause 41.13.1, at the first instance the umpire seeing the contravention shall, when the ball is dead, inform the other umpire. The bowler's end umpire shall then

- caution the captain of the fielding side and indicate that this is a first and final warning. This warning shall apply throughout the innings.
- inform the batters of what has occurred.

- 41.12.3 If, in that innings, there is any further instance of avoidable damage to the pitch, by any fielder, the umpire seeing the contravention shall, when the ball is dead, inform the other umpire. The bowler's end umpire shall then
- award 5 Penalty runs to the batting side.
- Additionally the umpire shall
- inform the fielding captain of the reason for this action.
 - inform the batters and, as soon as practicable, the captain of the batting side of what has occurred.
- The umpires together shall report the occurrence to the ICC Match Referee who shall take such action as is considered appropriate against the fielder concerned.

41.13 Bowler running on protected area

- 41.13.1 It is unfair for a bowler to enter the protected area in her follow-through without reasonable cause, whether or not the ball is delivered.
- 41.13.2 If a bowler contravenes this clause, at the first instance and when the ball is dead, the umpire shall
- caution the bowler and inform the other umpire of what has occurred. This caution shall apply to that bowler throughout the innings.
 - inform the captain of the fielding side and the batters of what has occurred.
- 41.13.3 If, in that innings, the same bowler again contravenes this clause, the umpire shall repeat the above procedure indicating that this is a final warning. This warning shall also apply throughout the innings.
- 41.13.4 If, in that innings, the same bowler contravenes this clause a third time, when the ball is dead, the umpire shall,
- direct the captain of the fielding side to suspend the bowler immediately from bowling. If applicable, the over shall be completed by another bowler, who shall neither have bowled any part of the previous over, nor be allowed to bowl any part of the next over. The bowler taken off shall not be allowed to bowl again in that innings.
 - inform the other umpire of the reason for this action.
 - inform the batters and, as soon as practicable, the captain of the batting side of what has occurred.
- The umpires may then report the matter to the ICC Match Referee who shall take such action as is considered appropriate against the bowler concerned.

41.14 Batter damaging the pitch

- 41.14.1 It is unfair to cause deliberate or avoidable damage to the pitch. If the striker enters the protected area in playing or playing at the ball, she must move from it immediately thereafter. A batter will be deemed to be causing avoidable damage if either umpire considers that her presence on the pitch is without reasonable cause.
- 41.14.2 If either batter causes deliberate or avoidable damage to the pitch, other than as in clause 41.15, at the first instance the umpire seeing the contravention shall, when the ball is dead, inform the other umpire of the occurrence. The bowler's end umpire shall then
- warn both batters that the practice is unfair and indicate that this is a first and final warning. This warning shall apply throughout the innings. The umpire shall so inform each incoming batter.
 - inform the captain of the fielding side and, as soon as practicable, the captain of the batting side of what has occurred.
- 41.14.3 If there is any further instance of avoidable damage to the pitch by any batter in that innings, the umpire seeing the contravention shall, when the ball is dead, inform the other umpire of the occurrence.
- The bowler's end umpire shall
- disallow all runs to the batting side.
 - return any not out batter to her original end.
 - signal No ball or Wide to the scorers if applicable.
 - award 5 Penalty runs to the fielding side.
 - award any other 5-run Penalty that is applicable except for Penalty runs under clause 28.3 (Protective helmets belonging to the fielding side).
 - Inform the captain of the fielding side and, as soon as practicable, the captain of the batting side of the reason for this action.
- The umpires together shall report the occurrence to the ICC Match Referee who shall take such action as is considered appropriate against the batter concerned.

41.15 Striker in protected area

- 41.15.1 The striker shall not adopt a stance in the protected area or so close to it that frequent encroachment is inevitable.
- The striker may mark a guard on the pitch provided that no mark is unreasonably close to the protected area.
- 41.15.2 If either umpire considers that the striker is in breach of any of the conditions in clause 41.15.1, if the bowler has not entered the delivery stride, he/she shall immediately call Dead ball, otherwise, wait until the ball is dead; he/she shall then inform the other umpire of the occurrence.

The bowler's end umpire shall then

- warn the striker that the practice is unfair and indicate that this is a first and final warning. This warning shall apply throughout the innings. The umpire shall so inform the non-striker and each incoming batter.
- inform the captain of the fielding side and, as soon as practicable, the captain of the batting side of what has occurred.

41.15.3 If there is any further breach of any of the conditions in clause 41.15.1 by any batter in that innings, the umpire seeing the contravention shall, if the bowler has not entered her delivery stride, immediately call and signal Dead ball, otherwise, he/she shall wait until the ball is dead and then inform the other umpire of the occurrence.

The bowler's end umpire shall

- disallow all runs to the batting side.
- return any not out batter to her original end.
- signal No ball or Wide to the scorers if applicable.
- award 5 Penalty runs to the fielding side.
- award any other 5-run Penalty that is applicable except for Penalty runs under clause 28.3 (Protective helmets belonging to the fielding side).
- inform the captain of the fielding side and, as soon as practicable, the captain of the batting side of the reason for this action.

The umpires together shall report the occurrence to the ICC Match Referee who shall take such action as is considered appropriate against the batter concerned.

41.16 Non-striker leaving her ground early

If the non-striker is out of her ground from the moment the ball comes into play to the instant when the bowler would normally have been expected to release the ball, the bowler is permitted to attempt to run her out. Whether the attempt is successful or not, the ball shall not count as one in the over.

If the bowler fails in an attempt to run out the non-striker, the umpire shall call and signal Dead ball as soon as possible.

41.17 Batters stealing a run

41.17.1 It is unfair for the batters to attempt to steal a run during the bowler's run-up.

Unless the bowler attempts to run out either batter – see clauses 41.16 and 21.4 (Bowler throwing towards striker's end before delivery) – the umpire shall

- call and signal Dead ball as soon as the batters cross in such an attempt.
- inform the other umpire of the reason for this action.

The bowler's end umpire shall then

- return the batters to their original ends.
- award 5 Penalty runs to the fielding side.
- inform the batters, the captain of the fielding side and, as soon as practicable, the captain of the batting side, of the reason for this action.

The umpires may then report the matter to the ICC Match Referee who shall take such action as is considered appropriate against the batter concerned.

41.18 Penalty runs

41.18.1 When Penalty runs are awarded to either side, when the ball is dead the umpire shall signal the Penalty runs to the scorers. See clause 2.13 (Signals).

41.18.2 Penalty runs shall be awarded in each case where these Playing Conditions require the award, even if a result has already been achieved. See clause 16.6 (Winning hit or extras).

Note, however, that the restrictions on awarding Penalty runs, in clauses 23.3 (Leg byes not to be awarded), 34.4 (Runs scored from ball lawfully struck more than once) and 28.3 (Protective helmets belonging to the fielding side), will apply.

41.18.3 When 5 Penalty runs are awarded to the batting side under any of clauses 24.4 (Player returning without permission), 28.2 (Fielding the ball), 28.3 (Protective helmets belonging to the fielding side) or under 41.3, 41.4, 41.5, 41.9 or 41.12, then

- they shall be scored as Penalty extras and shall be in addition to any other penalties.
- they are awarded when the ball is dead and shall not be regarded as runs scored from either the immediately preceding delivery or the immediately following delivery, and shall be in addition to any runs from those deliveries.
- the batters shall not change ends solely by reason of the 5 run penalty.

41.18.4 When 5 Penalty runs are awarded to the fielding side, under clause 18.5.2 (Deliberate short runs), or under 41.10, 41.14, 41.15 or 41.17, they shall be added as Penalty extras to that side's total of runs in its most recently completed innings. If the fielding side has not completed an innings, the 5 Penalty runs shall be added to the score in its next innings.

42 PLAYERS' CONDUCT

42.1 Serious misconduct

42.1.1 The umpires shall act upon any serious misconduct. The relevant offences and the corresponding actions by the umpires are identified in clause 42.2.1. These offences correspond with Level 4 offences in the ICC Code of Conduct. Level 1 to Level 3 offences continue to be dealt with separately under the ICC Code of Conduct.

- 42.12 If either umpire considers that a player has committed one of these offences at any time during the match, the umpire concerned shall call and signal Dead ball. This call may be delayed until the umpire is satisfied that it will not disadvantage the non-offending side.
- 42.13 The umpire concerned shall report the matter to the other umpire and together they shall decide whether an offence has been committed. The umpires may also consult with the third umpire and the match referee, who may review any audio or video replays to confirm whether an offence has been committed. If so, the umpires shall then apply the related sanctions.
- 42.14 If the offence is committed by a batter, the umpires shall summon the offending player's captain to the field. Solely for the purpose of this clause, the batters at the wicket may not deputise for their captain.

42.2 Level 4 offences and action by umpires

- 42.2.1 Any of the following actions by a player shall constitute a Level 4 offence:
- threatening to assault an umpire
 - making inappropriate and deliberate physical contact with an umpire
 - physically assaulting a player or any other person
 - committing any other act of violence.
- 42.2.2 If such an offence is committed, 42.2.2.1 to 42.2.2.5 shall be implemented.
- 42.2.2.1 The umpire shall call Time.
- 42.2.2.2 Together the umpires shall summon and inform the offending player's captain that an offence at this Level has occurred.
- 42.2.2.3 The umpires shall instruct the captain to remove the offending player immediately from the field of play for the remainder of the match and shall apply the following:
- 42.2.2.3.1 If the offending player is a fielder, no substitute shall be allowed for her. She is to be recorded as Retired – out at the commencement of any subsequent innings in which her team is the batting side.
- 42.2.2.3.2 If a bowler is suspended mid-over, then that over must be completed by a different bowler, who shall not have bowled the previous over nor shall be permitted to bowl the next over.

- 42.2.2.3.3 If the offending player is a batter she is to be recorded as Retired – out in the current innings, unless she has been dismissed under any of clauses 32 to 39, and at the commencement of any subsequent innings in which her team is the batting side. If no further batter is available to bat, the innings is completed.
- 42.2.2.4 As soon as practicable, the umpire shall:
- award 5 Penalty runs to the opposing team
 - signal the Level 4 penalty to the scorers
 - call Play.
- 42.2.2.5 The umpires shall then report the matter to the ICC Match Referee under the ICC Code of Conduct.

42.3 Captain refusing to remove a player from the field

- 42.3.1 If a captain refuses to carry out an instruction under 42.2.2.3, the umpires shall invoke clause 16.2 (ICC Match Referee awarding a match).
- 42.3.2 If both captains refuse to carry out instructions under 42.2.2.3 in respect of the same incident, the umpires shall instruct the players to leave the field. The match is not concluded as in clause 12.6 and there shall be no result under clause 16.

42.4 Additional points relating to Level 4 offences

- 42.4.1 If a player, while acting as wicket-keeper, commits a Level 4 offence, clause 24.1.2 shall not apply, meaning that only a nominated player may keep wicket, even if another fielder becomes injured or ill and is replaced by a substitute.
- 42.4.2 A nominated player who has a substitute will also suffer the penalty for any Level 4 offence committed by the substitute. However, only the substitute will be reported under clause 42.2.2.5.

APPENDICES TO ICC WOMEN'S CHAMPIONSHIP PLAYING CONDITIONS

(INCORPORATING THE 2017 CODE OF THE MCC LAWS OF CRICKET)

A. Definitions

B. Equipment

1. The bat
2. The wickets
3. Wicket-keeping gloves

C. The venue

1. The pitch and the creases
2. Advertising on grounds, perimeter boards and sight-screens
3. Markings on outfield

D. Decision Review System (DRS) and Third Umpire Protocol

E. Calculations

APPENDIX A

DEFINITIONS

1 THE MATCH

- 1.1 **The game** is used in these Playing Conditions as a general term meaning the Game of Cricket.
- 1.2 **A match** is a single One Day International between two teams, played under these Playing Conditions.
- 1.3 **ODI** is an abbreviation for One Day International.
- 1.4 **The toss** is the toss for choice of innings.
- 1.5 **Before the toss** is at any time before the toss on the day the match is expected to start.
- 1.6 **Before the match** is at any time before the toss, not restricted to the day of the match.
- 1.7 **During the match** is at any time after the toss until the conclusion of the match, whether play is in progress or not.
- 1.8 **Playing time** is any time between the call of Play and the call of Time. See clauses 12.1 (Call of Play) and 12.2 (Call of Time).
- 1.9 **Conduct of the match** includes any action relevant to the match at any time.
- 1.10 **Ground Authority** is the entity responsible for the selection and preparation of the pitch and other functions relating to the hosting and management of the match, including any agents acting on their behalf (including but not limited to the curator or other ground staff).
- 1.11 **Home Board** is the ICC member responsible for the home team and the hosting of the match.
- 1.12 **Visiting Board** is the ICC member responsible for the visiting team.
- 1.13 **The Spirit of Cricket** refers to the values of respect and fair play that underpin the game of cricket, as set out in the Preamble to these Playing Conditions.
- 1.14 **The ICC Code of Conduct** is the ICC Code of Conduct for Players and Player Support Personnel, as amended from time to time.

2 IMPLEMENTS AND EQUIPMENT

- 2.1 **Implements used in the match** are the bat, the ball, the stumps and bats.
- 2.2 **External protective equipment** is any visible item of apparel worn for protection against external blows.

For a batter, items permitted are a protective helmet, external leg guards (batting pads), batting gloves and, if visible, forearm guards.

For a fielder, only a protective helmet is permitted, except in the case of a wicket-keeper, for whom wicket-keeping pads and gloves are also permitted.

- 2.3 A protective helmet** is headwear made of hard material and designed to protect the head or the face or both, which shall (in line with the Clothing and Equipment Regulations) be certified to BS7928:2013. For the purposes of interpreting these Playing Conditions, such a description will include faceguards.
- 2.4 Equipment** – a batter's equipment is her bat as defined above, together with any external protective equipment she is wearing.
A fielder's equipment is any external protective equipment that she is wearing.
- 2.5 The bat** – the following are to be considered as part of the bat:
- the whole of the bat itself.
 - the whole of a glove (or gloves) worn on the hand (or hands) holding the bat.
 - the hand (or hands) holding the bat, if the batter is not wearing a glove on that hand or on those hands.
- 2.6 Held in batter's hand.** Contact between a batter's hand, or glove worn on her hand, and any part of the bat shall constitute the bat being held in that hand.

3 THE PLAYING AREA

- 3.1 The field of play** is the area contained within the boundary.
- 3.2 The square** is a specially prepared area of the field of play within which the match pitch is situated.
- 3.3 The outfield** is that part of the field of play between the square and the boundary.

4 POSITIONING

- 4.1 Behind the popping crease** at one end of the pitch is that area of the field of play, including any other marking, objects and persons therein, that is on that side of the popping crease that does not include the creases at the opposite end of the pitch. Behind, in relation to any other marking, object or person, follows the same principle. See the diagram in paragraph 13.
- 4.2 In front of the popping crease** at one end of the pitch is that area of the field of play, including any other marking, objects and persons therein, that is on that side of the popping crease that includes the creases at the opposite end of the pitch. In front of, in relation to any other marking, object or person, follows the same principle. See the diagram in paragraph 13.
- 4.3 The striker's end** is the place where the striker stands to receive a delivery from the bowler only insofar as it identifies, independently of where the striker may subsequently move, one end of the pitch.
- 4.4 The bowler's end** is the end from which the bowler delivers the ball. It is the other end of the pitch from the striker's end and identifies that end of the pitch that is not the striker's end as described in paragraph 4.3.

- 4.5 The wicket-keeper's end** is the same as the striker's end as described in paragraph 4.3.
- 4.6 In front of the line of the striker's wicket** is in the area of the field of play in front of the imaginary line joining the fronts of the stumps at the striker's end; this line to be considered extended in both directions to the boundary. See paragraph 4.2.
- 4.7 Behind the wicket** is in the area of the field of play behind the imaginary line joining the backs of the stumps at the appropriate end; this line to be considered extended in both directions to the boundary. See paragraph 4.1.
- 4.8 Behind the wicket-keeper** is behind the wicket at the striker's end, as defined above, but in line with both sets of stumps and further from the stumps than the wicket-keeper.
- 4.9 Off side/on (leg) side** – see diagram in paragraph 13.
- 4.10 Inside edge** is the edge on the same side as the nearer wicket.

5 UMPIRES AND DECISION-MAKING

- 5.1 Umpire** – where the description the umpire is used on its own, it always means 'the bowler's end umpire' though this full description is sometimes used for emphasis or clarity. Similarly the umpires always means both umpires and the third umpire. **An umpire** and **umpires** are generalised terms. Otherwise, a fuller description indicates which one of the umpires is specifically intended. Each umpire will be bowler's end umpire and striker's end umpire in alternate overs.
- 5.2 Bowler's end umpire** is the umpire who is standing at the bowler's end (see paragraph 4.4) for the current delivery.
- 5.3 Striker's end umpire** is the umpire who is standing at the striker's end (see paragraph 4.3), to one side of the pitch or the other, depending on his/her choice, for the current delivery.
- 5.4 On-field umpires** shall mean, collectively, the bowler's end umpire and the striker's end umpire.
- 5.5 Third umpire** is the umpire who may use television evidence and other available technology in order review a decision of the on-field umpires, either by way of an Umpire Review or a Player Review under the protocol set out in Appendix D.
- 5.6 Umpires together agree** applies to decisions which the umpires are to make jointly, independently of the players.
- 5.7 Decision Review System** or **DRS** is the process covered by the Decision Review System and Third Umpire Protocol set out in Appendix D, under which the third umpire may be consulted in relation to a decision of the on-field umpires, either by way of an Umpire Review or a Player Review.
- 5.8 Player Review** is the process set out in Appendix D by which a player may request a review of any decision taken by the on-field umpires concerning whether or not a batter is dismissed (with the exception of 'Timed out').
- 5.9 Umpire Review** is the process set out in Appendix D by which an on-field umpire has the discretion to refer a decision to the third umpire or, under certain circumstances, to consult with the third umpire before making a decision.

- 5.10 Soft Signal** is the visual communication by the bowler's end umpire to the third umpire (accompanied by additional information via two-way radio where necessary) of his/her initial on-field decision prior to initiating an Umpire Review.
- 5.11 Umpire's Call** is the concept within the DRS under which the on-field decision of the bowler's end umpire shall stand, which shall apply under the specific circumstances set out in paragraphs 3.4.5 and 3.4.6 of Appendix D, where the ball-tracking technology indicates a marginal decision in respect of either the Impact Zone or the Wicket Zone.
- 5.12 The Pitching Zone** as used in the DRS is a two dimensional area on the pitch between both sets of stumps with its boundaries consisting of the base of both sets of stumps and a line between the outside of the outer stumps at each end.
- 5.13 The Impact Zone** as used in the DRS is a three dimensional space extending between both sets of stumps to an indefinite height vertically and with its boundaries consisting of the base of the stumps and the outside of the outer stumps at each end.
- 5.14 The Wicket Zone** as used in the DRS is a two dimensional area with its boundaries consisting of the outside of the outer stumps, the base of the stumps, and the lower edge of the bails.
- 5.15 A Fair Catch** is a catch that has been taken cleanly by the fielder in accordance with clause 33.
- 5.16 A Bump Ball** is where the ball has made contact with the ground shortly after making contact with the striker's bat.
- 5.17 The Elite Panel** is the group of umpires contracted to the ICC to officiate in international cricket.
- 5.18 The International Panel** is the group of umpires nominated by the ICC's full members in accordance with clause Error! Reference source not found. of the Playing Conditions.
- 5.19 The First-Class Panel** is the group of umpires nominated by the ICC's full members in accordance with clause 2.1.3 of the Playing Conditions.
- 5.20 The ICC Development Panel** is the group of umpires nominated by the ICC's full and associate members in accordance with clause 2.1.3 of the Playing Conditions.
- 5.21 The International Panel of Referees** is the group of referees nominated by the ICC's full members in accordance with clause 2.1.6 of the Playing Conditions.

6 BATTERS

- 6.1 Batting side** is the side currently batting, whether or not play is in progress.
- 6.2 Member of the batting side** is one of the players nominated by the captain of the batting side, or any authorised replacement for such nominated player.
- 6.3 A batter's ground** – at each end of the pitch, the whole area of the field of play behind the popping crease is the ground at that end for a batter.
- 6.4 Original end** is the end where a batter was when the ball came into play for that delivery.
- 6.5 Wicket she has left** is the wicket at the end where a batter was at the start of the run in progress.
- 6.6 Guard position** is the position and posture adopted by the striker to receive a ball delivered by the bowler.
- 6.7** For the purposes of these Playing Conditions, waist height is defined as the point at which the top of the batter's trousers would conventionally be when she is standing upright at the popping crease.

7 FIELDERS

- 7.1 Fielding side** is the side currently fielding, whether or not play is in progress.
- 7.2 Member of the fielding side** is one of the players nominated by the captain of the fielding side, or any authorised replacement or substitute for such nominated player.
- 7.3 Fielder** is one of the 11 or fewer players who together represent the fielding side on the field of play. This definition includes not only both the bowler and the wicket-keeper but also nominated players who are legitimately on the field of play, together with players legitimately acting as substitutes for absent nominated players. It excludes any nominated player who is absent from the field of play, or who has been absent from the field of play and who has not yet obtained the umpire's permission to return.

A player going briefly outside the boundary in the course of discharging her duties as a fielder is not absent from the field of play nor, for the purposes of clause 24.2 (Fielder absent or leaving the field of play), is she to be regarded as having left the field of play.

8 SUBSTITUTES AND CONCUSSION REPLACEMENTS

- 8.1 A Substitute** is a player who takes the place of a fielder on the field of play, but does not replace the player for whom she substitutes on that side's list of nominated players. A substitute's activities are limited to fielding.
- 8.2 A Concussion Replacement** is a player who takes the place of a player who has been replaced in accordance with the process set out in clause 12.7, and who for the remainder of the match replaces that player on that side's list of nominated players, being able to take a full part in the match (subject to such restrictions as may be imposed by the ICC Match Referee in accordance with clause 12.8
- 8.3 A Concussion Replacement Request** is the notification made to the ICC Match Referee in accordance with the process set out in clause 12.7.3

- 8.4 The **Team Medical Representative** is the individual designated as having responsibility for the assessment of any head or neck injury sustained by a player as set out in clause 12.7.2

9 BOWLERS

- 9.1 **Over the wicket/round the wicket** – If, as the bowler runs up between the wicket and the return crease, the wicket is on the same side as her bowling arm, she is bowling over the wicket. If the return crease is on the same side as her bowling arm, she is bowling round the wicket.
- 9.2 **Delivery swing** is the motion of the bowler's arm during which she normally releases the ball for a delivery.
- 9.3 **Delivery stride** is the stride during which the delivery swing is made, whether the ball is released or not. It starts when the bowler's back foot lands for that stride and ends when the front foot lands in the same stride. The stride after the delivery stride is completed when the next foot lands, i.e. when the back foot of the delivery stride lands again.
- 9.4 The **Illegal Bowling Regulations** are the ICC's regulations governing Illegal Bowling Actions.
- 9.5 An **Illegal Bowling Action** is a bowling action where a bowler's Elbow Extension exceeds 15 degrees, measured from the point at which the bowling arm reaches the horizontal until the point at which the ball is released (any Elbow Hyperextension shall be discounted for the purposes of determining an Illegal Bowling Action).
- 9.6 **Elbow Extension** means the motion that occurs when a bowler's arm moves from a flexed (bent) position at the elbow, to a more extended (straight) position (full Elbow Extension occurs when the arm is straight).
- 9.7 **Elbow Hyperextension** is the motion that occurs when a bowler's elbow extends beyond the straight position.
- 9.8 The **ICC Bowling Action Report Form** is the form provided for by Article 3 of the Illegal Bowling Regulations, by which an umpire and/or the ICC Match Referee may submit a report relating to a suspected Illegal Bowling Action.

10 THE BALL

- 10.1 **The ball is struck/strikes the ball** unless specifically defined otherwise, mean 'the ball is struck by the bat'/'strikes the ball with the bat'.
- 10.2 **Rebounds directly/strikes directly** and similar phrases mean 'without contact with any fielder' but do not exclude contact with the ground.
- 10.3 **Full-pitch** describes a ball delivered by the bowler that reaches or passes the striker without having touched the ground. Sometimes described as non-pitching.

11 RUNS

- 11.1 **A run to be disallowed** is one that in these Playing Conditions should not have been taken. It is not only to be cancelled but the batters are to be returned to their original ends.
- 11.2 **A run not to be scored** is one that is not illegal, but is not recognised as a properly executed run. It is not a run that has been made, so the question of cancellation does not arise. The loss of the run so attempted is not a disallowance and the batters will not be returned to their original ends on that account.

12 THE PERSON

- 12.1 **Person;** A player's person is her physical person (flesh and blood) together with any clothing or legitimate external protective equipment that she is wearing except, in the case of a batter, her bat.
- A hand, whether gloved or not, that is not holding the bat is part of the batter's person.
- No item of clothing or equipment is part of the player's person unless it is attached to her.
- For a batter, a glove being held but not worn is part of her person.
- For a fielder, an item of clothing or equipment she is holding in her hand or hands is not part of her person.
- 12.2 **Clothing** – anything that a player is wearing, including such items as spectacles or jewellery, that is not classed as external protective equipment is classed as clothing, even though she may be wearing some items of apparel, which are not visible, for protection. A bat being carried by a batter does not come within this definition of clothing.
- 12.3 **Hand** for batter or wicket-keeper shall include both the hand itself and the whole of a glove worn on the hand.

13 OFF SIDE/ON SIDE; IN FRONT OF/
BEHIND THE POPPING CREASE

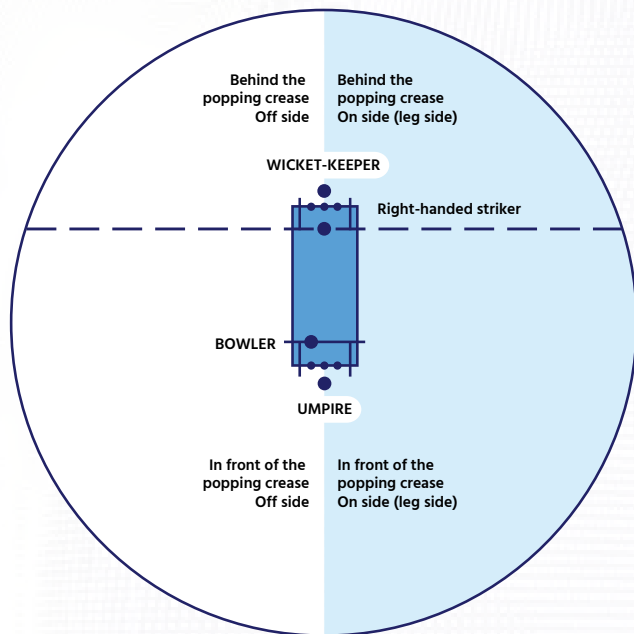

APPENDIX B

EQUIPMENT

1 THE BAT

1.1 General guidance

- 1.1.1 Measurements – All provisions in paragraphs 1.2 to 1.6 below are subject to the measurements and restrictions stated in the Playing Conditions and this Appendix.
- 1.1.2 Adhesives – Throughout, adhesives are permitted only where essential and only in minimal quantity.

1.2 Specifications for the Handle

- 1.2.1 One end of the handle is inserted into a recess in the blade as a means of joining the handle and the blade.

This lower portion is used purely for joining the blade and the handle together. It is not part of the blade but, solely in interpreting paragraphs 1.3 and 1.4 below, references to the blade shall be considered to extend also to this lower portion of the handle where relevant.
- 1.2.2 The handle may be glued where necessary and bound with twine along the upper portion.

Providing clause 5.5 is not contravened, the upper portion may be covered with materials solely to provide a surface suitable for gripping. Such covering is an addition and is not part of the bat, except in relation to clause 5.6. The bottom of this grip should not extend below the point defined in paragraph 1.2.4 below.

Twine binding and the covering grip may extend beyond the junction of the upper and lower portions of the handle, to cover part of the shoulders of the bat as defined in paragraph 1.3.1.

No material may be placed on or inserted into the lower portion of the handle other than as permitted above together with the minimal adhesives or adhesive tape used solely for fixing these items, or for fixing the handle to the blade.
- 1.2.3 Materials in handle – As a proportion of the total volume of the handle, materials other than cane, wood or twine are restricted to one-tenth. Such materials must not project more than 3.25 in/8.26 cm into the lower portion of the handle.
- 1.2.4 Binding and covering of handle – The permitted continuation beyond the junction of the upper and lower portions of the handle is restricted to a maximum, measured along the length of the handle, of
 - 2.5 in/6.35 cm in for the twine binding
 - 2.75 in/6.99 cm for the covering grip.

1.3 Specifications for the Blade

- 1.3.1 The blade has a face, a back, a toe, sides and shoulders
- 1.3.1.1 The face of the blade is its main striking surface and shall be flat or have a slight convex curve resulting from traditional pressing techniques. The back is the opposite surface.
- 1.3.1.2 The shoulders, sides and toe are the remaining surfaces, separating the face and the back.
- 1.3.1.3 The shoulders, one on each side of the handle, are along that portion of the blade between the first entry point of the handle and the point at which the blade first reaches its full width.
- 1.3.1.4 The toe is the surface opposite to the shoulders taken as a pair.
- 1.3.1.5 The sides, one each side of the blade, are along the rest of the blade, between the toe and the shoulders.
- 1.3.2 No material may be placed on or inserted into the blade other than as permitted in paragraph 1.2.4, paragraph 1.3.3, and clause 5.4 together with the minimal adhesives or adhesive tape used solely for fixing these items, or for fixing the handle to the blade.
- 1.3.3 Covering the blade. Bats shall have no covering on the blade except as permitted in clause 5.4.

Any materials referred to above, in clause 5.4 and paragraph 1.4 below, are to be considered as part of the bat, which must still pass through the gauge as defined in paragraph 1.6.

1.4 Protection and repair

- 1.4.1 The surface of the blade may be treated with non-solid materials to improve resistance to moisture penetration and/or mask natural blemishes in the appearance of the wood. Save for the purpose of giving a homogeneous appearance by masking natural blemishes, such treatment shall not materially alter the colour of the blade.
- 1.4.2 Materials can be used for protection and repair as stated in clause 5.4 and are additional to the blade. Note however clause 5.6.
- Any such material shall not extend over any part of the back of the blade except in the case of clause 5.4.1 and then only when it is applied as a continuous wrapping covering the damaged area.
- The repair material shall not extend along the length of the blade more than 0.79 in/2.0 cm in each direction beyond the limits of the damaged area. Where used as a continuous binding, any overlapping shall not breach the maximum of 0.04 in/0.1 cm in total thickness.
- The use of non-solid material which when dry forms a hard layer more than 0.004 in/0.01 cm in thickness is not permitted.
- 1.4.3 Permitted coverings, repair material and toe guards, not exceeding their specified thicknesses, may be additional to the dimensions above, but the bat must still pass through the gauge as described in paragraph 1.6.

1.5 Commercial identifications

Such identifications shall comply with the restrictions set out in the Clothing and Equipment Regulations in relation to the size and position of marks and logos.

1.6 Bat Gauge

All bats must meet the specifications defined in clause 5.7. They must also, with or without protective coverings permitted in clause 5.4, be able to pass through a bat gauge, the dimensions and shape of which are shown in the following diagram:

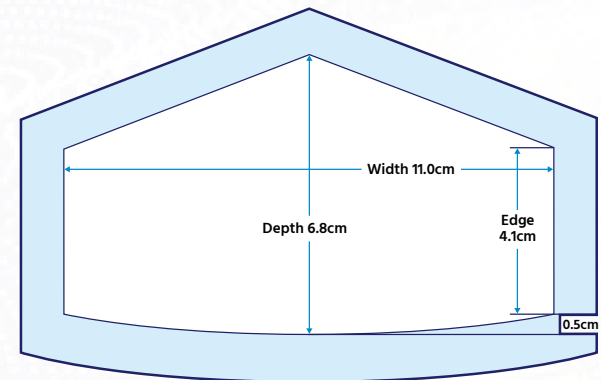
**DIMENSIONS OF APERTURE**

Total Depth: 2.68 in/6.8 cm

Width: 4.33 in/11.0 cm

Edge: 1.61 in/4.1 cm

Curve: 0.20 in/0.5 cm

Note: The curve of the lower edge of the aperture is an arc of a circle of radius 12.0 in/30.5 cm, whose centre is on the vertical centre line of the aperture.

2 THE WICKETS**2.1 Bails**

Overall 4.31 in/10.95 cm

a = 1.38 in/3.50 cm

b = 2.13 in/5.40 cm

c = 0.81 in/2.06 cm

2.2 Stumps

Height (d) = 28 in/71.1 cm

Diameter (e) - maximum = 1.5 in/3.81 cm; minimum = 1.38 in/3.50 cm

2.3 Overall

Width (f) of wicket 9 in/22.86 cm

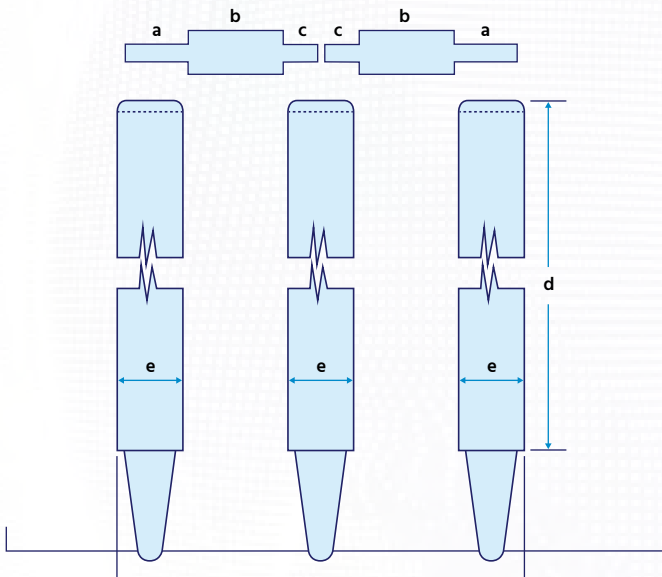
**3 WICKET-KEEPING GLOVES**

3.1 The images below illustrate the requirements of clause 27.2 in relation to:

- no webbing between the fingers;
- a single piece of non-stretch material between finger and thumb as a means of support; and
- when a hand wearing the glove has the thumb fully extended, the top edge being taut and not protruding beyond the straight line joining the top of the index finger to the top of the thumb.

3.2 Note also the requirement for wicket-keeping gloves to comply with the Clothing and Equipment Regulations in relation to the size and position of marks and logos.



APPENDIX C

THE VENUE

1 THE PITCH AND THE CREASES

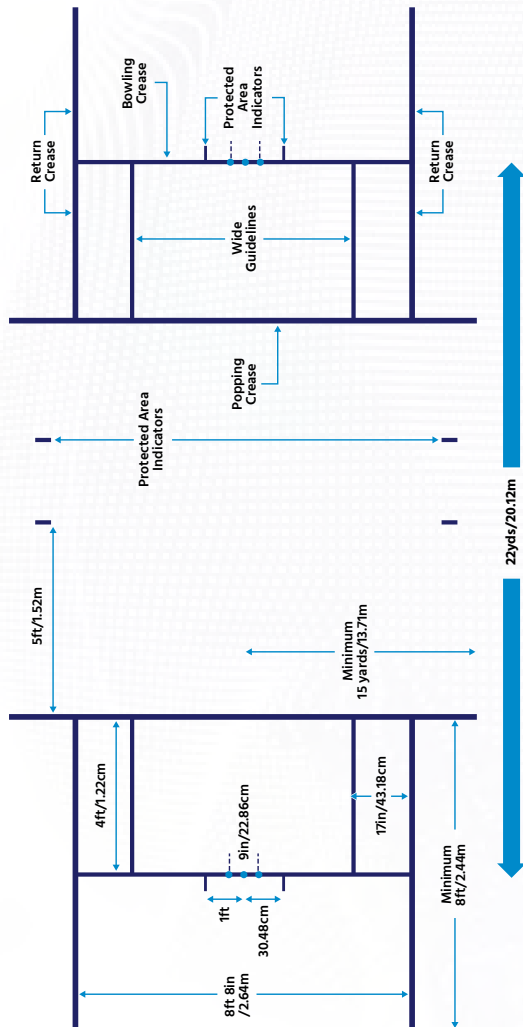

2 RESTRICTION ON THE PLACEMENT OF FIELDERS

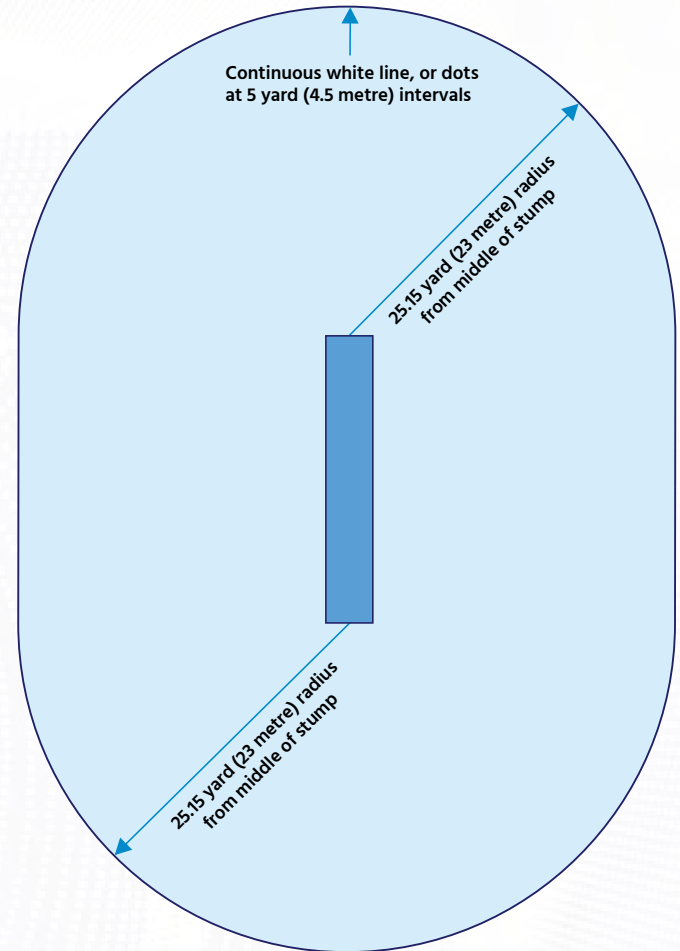

3 ADVERTISING ON GROUNDS, PERIMETER BOARDS AND SIGHT-SCREENS

3.1 Advertising on grounds

- 3.1.1 The logos on outfielders are to be positioned as follows:
- Behind the stumps – a minimum of 25.15 yards (23 meters) from the stumps.
 - Midwicket/cover area – no advertising to be positioned within 30 yards (27.50 meters) of the centre of the pitch being used for the match.
- 3.1.2 Note: Advertising closer to the stumps as set out above which is required to meet 3D requirements for broadcasters may be permitted, subject to prior ICC approval having been obtained.

3.2 Perimeter boards

- 3.2.1 Advertising on perimeter boards placed in front of the sight-screens is permitted save that the predominant colour of such advertising shall be of a contrasting colour to that of the ball.
- 3.2.2 Advertising on perimeter boards behind the stumps at both ends shall not contain moving, flashing or flickering images and operators should ensure that the images are only changed or moved at a time that will not be distracting to the players or the umpires.
- 3.2.3 The brightness of any electronic images shall be set at a level so that it is not a distraction to the players or umpires.

3.3 Sight-screens

- 3.3.1 Sight-screens shall be provided at both ends of all grounds.
- 3.3.2 Advertising shall be permitted on the sight-screen behind the striker, providing it is removed for the subsequent over from that end.
- 3.3.3 Such advertising shall not contain flashing or flickering images and particular care should be taken by the operators that the advertising is not changed at a time which is distracting to the umpire.

4 MARKINGS ON OUTFIELD

With the permission of the Ground Authority, a bowler may use paint to make a small marking on the outfield for the purposes of identifying their run-up. Paint used for this purpose shall be any colour other than white.

APPENDIX D

DECISION REVIEW SYSTEM (DRS) AND THIRD UMPIRE PROTOCOL

1 GENERAL

1.1 Minimum requirements for use of DRS and appointment of third umpire

- 1.1.1 The Home Board shall endeavor to broadcast all ODI Matches played in its country.
- 1.1.2 Where matches are broadcast, the camera specification set out below shall be mandatory as a minimum requirement.

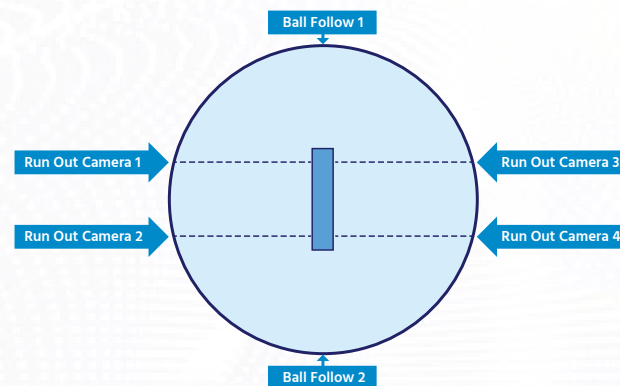

- 1.1.3 Where the camera specification set out above is provided, a third umpire shall be appointed to the match.
- 1.1.4 If the minimum requirements for DRS to be used are satisfied, both participating Boards may agree to employ the DRS for an ODI. Otherwise, the third umpire shall be appointed and empowered to use broadcast replays to make decisions that are referred to him/her in accordance with paragraph 2 (Umpire Reviews).

- 1.1.5 The table below summarises the minimum requirements for DRS to be used, and the recommended regulations around the appointment of the third umpire:

	THIRD UMPIRE (NON-DRS)	DRS
Minimum Requirement	Cameras Specification detailed in paragraph 1.1.2.	Cameras <ul style="list-style-type: none"> - Specification detailed in paragraph 1.1.2. Technology. - Approved ball-tracking technology. - Approved sound-based edge detection technology.
Third Umpire Appointment	Appointed by Home Board from ICC Elite Panel, International Panel or First Class Panel of umpires.	Appointed by the Home Board, from ICC Elite Panel or International Panel of umpires.
Third Umpire Jurisdiction	Umpire Reviews only.	Umpire Reviews and Player Reviews.
Replays that can be used	The third umpire shall only have access to replays of any camera images. Other technology which may be in use by the broadcaster for broadcast purposes (for example, ball-tracking technology, sound-based edge detection technology, and heat-based edge detection technology) shall not be used during Umpire Reviews.	Any replay, stump microphone audio or technology detailed in paragraph 3.8.1 below.
ICC Technical Officer	Not required.	The ICC shall appoint an independent technology expert (ICC Technical Officer) to be present at every series in which the DRS is used to assist the third umpire and to protect the integrity of the DRS process.

- 1.1.6 The Home Board shall ensure that a separate room is provided for the third umpire and that he/she has access to the television equipment and technology (where DRS is used) so as to be in the best position to facilitate the referral and/or consultation processes referred to in paragraphs 2 (Umpire Review) and 3 (Player Review) below.

2 UMPIRE REVIEW

For televised matches, in the circumstances detailed in paragraphs 2.1, 2.2, 2.3 and 2.4 below, the on-field umpire shall have the discretion to refer the decision to the third umpire or, in the case of paragraphs 2.2, and 2.4, to consult with the third umpire before making the decision.

Save for requesting the umpire to review his/her decision under paragraph 3 (Player Review) below, players may not appeal to the on-field umpires to use the Umpire Review. Breach of this provision may constitute dissent and the player may be subject to disciplinary action under the ICC Code of Conduct for Players and Player Support Personnel.

2.1 Run Out, Stumped, Bowled and Hit Wicket Decisions

- 2.1.1 The relevant on-field umpire shall be entitled to refer an appeal for run-out, stumped, bowled or hit wicket to the third umpire.
- 2.1.2 An on-field umpire wishing to refer a decision to the third umpire shall signal to the third umpire by making the shape of a TV screen with his/her hands.
- 2.1.3 In the case of a referral of a bowled, hit wicket or stumped decision, the third umpire shall first check the fairness of the delivery (all modes of No ball except for the bowler using an Illegal Bowling Action, subject to the proviso that the third umpire may review whether the bowler has used a prohibited Specific Variation under Article 6.2 of the Illegal Bowling Regulations). If the delivery was not a fair delivery the third umpire shall indicate that the batter is Not out and advise the on-field umpire to signal No ball. See also paragraph 2.5 below.
- 2.1.4 Additionally, if the third umpire finds the batter is Out by another mode of dismissal (excluding LBW), or Not out by any mode of dismissal (excluding LBW), he/she shall notify the on-field umpire so that the correct decision is made.
- 2.1.5 If the third umpire decides that the batter is Out, a red light shall be displayed; if the third umpire decides that the batter is Not out, a green light shall be displayed. Should the third umpire be temporarily unable to respond, a white light (where available) shall remain illuminated throughout the period of interruption to signify to the on-field umpires that Umpire Reviews are temporarily unavailable, in which case the decision shall be taken by the on-field umpire. As an alternative to the red/green light system, the replay screen (where available) may be used for the purpose of conveying the third umpire's decision, in line with the ICC Big Screen Policy.

2.2 Caught Decisions, Obstructing the Field

- 2.2.1 Where the bowler's end umpire is unable to decide upon a Fair Catch or a Bump Ball, or if, on appeal from the fielding side, the batter obstructed the field, he/she shall first consult with the striker's end umpire.
- 2.2.2 Should both on-field umpires require assistance from the third umpire to make a decision, the bowler's end umpire shall firstly take a decision on-field after consulting with the striker's end umpire, before consulting by two-way radio with the third umpire. Such consultation shall be initiated by the bowler's end umpire to the third umpire by making the shape of a TV screen with his/her hands, followed by a Soft Signal of Out or Not out made with the hands close to the chest at chest height. If the third umpire advises that the replay evidence is inconclusive, the on-field decision communicated at the start of the consultation process shall stand.
- 2.2.3 The third umpire shall determine whether the batter has been caught, whether the delivery was a Bump Ball, or if the batter obstructed the field. However, in reviewing the television replay(s), the third umpire shall first check the fairness of the delivery for all decisions involving a catch (all modes of No ball except for the bowler using an Illegal Bowling Action, subject to the proviso that the third umpire may review whether the bowler has used a prohibited Specific Variation under Article 6.2 of the Illegal Bowling Regulations) and whether the batter has hit the ball. If the delivery was not a fair delivery or if it is clear to the third umpire that the batter did not hit the ball he/she shall indicate to the bowler's end umpire that the batter is Not out caught, and in the case of an unfair delivery, advise the bowler's end umpire to signal No ball. See also paragraph 2.5 below. Additionally, if it is clear to the third umpire that the batter is Out by another mode of dismissal (excluding LBW), or Not out by any mode of dismissal (excluding LBW), he/she shall notify the bowler's end umpire so that the correct decision can be made.
- 2.2.4 The third umpire shall communicate his/her decision as set out in paragraph 2.1.5.

2.3 Boundary Decisions

- 2.3.1 The bowler's end umpire shall be entitled to refer to the third umpire for a decision on:
- 2.3.1.1 whether a four or six has been scored;
- 2.3.1.2 whether a fielder had any part of her person in contact with the ball when she touched the boundary; or
- 2.3.1.3 whether the fielder had any part of her person in contact with the ball when she had any part of her person grounded beyond the boundary.
- 2.3.2 A decision shall be made immediately and cannot be changed thereafter.

- 2.3.3 If the television evidence is inconclusive as to whether or not a boundary has been scored, the default presumption shall be in favour of no boundary being awarded.
- 2.3.4 Where the bowler's end umpire wishes to use the assistance of the third umpire in this circumstance, he/she shall communicate with the third umpire by use of a two-way radio and the third umpire shall convey his/her decision to the bowler's end umpire by the same method.
- 2.3.5 The third umpire may initiate contact with the on-field umpire by two-way radio if TV coverage shows a boundary line infringement or incident that appears not to have been acted upon by the on-field umpires.

2.4 Batters Running to the Same End

- 2.4.1 Where both batters have run to the same end and the on-field umpires are uncertain over which batter made her ground first, the on-field umpires may consult with the third umpire.
- 2.4.2 The procedure set out in paragraph 2.3.4 shall apply.

2.5 No Balls

- 2.5.1 If the bowler's end umpire is uncertain as to the fairness of the delivery following a dismissal, either affecting the validity of the dismissal or which batter is dismissed, he/she shall be entitled to request the batter to delay leaving the field and to check the fairness of the delivery with the third umpire. Communication with the third umpire shall be by two-way radio.
- 2.5.2 The third umpire shall check all modes of No ball except for the bowler using an Illegal Bowling Action (subject to the proviso that the third umpire may review whether the bowler has used a prohibited Specific Variation under Article 6.2 of the Illegal Bowling Regulations). The third umpire shall apply clause 21.5 when deciding whether a No ball should have been called (and must therefore be satisfied that none of the three conditions in clause 21.5 have been met before calling a No ball).
- 2.5.3 If the delivery was not a fair delivery, the bowler's end umpire shall indicate that the batter is Not out and signal No ball (except in the case of a dismissal for obstructing the field, which may still be effected despite a No ball being called, in which case the bowler's end umpire shall indicate that the relevant batter is Out and additionally call a No ball).
- 2.5.4 If a No ball is called following the check by the third umpire, the batting side shall benefit from the reversal of the dismissal and the one run for the No ball, but shall not benefit from any runs that may subsequently have accrued from the delivery had the on-field umpire originally called a No ball. Where the batters crossed while the ball was in the air before being caught, the batters shall remain at the same ends as if the striker had been dismissed, but no runs shall be credited to the striker even if one (or more) runs were completed prior to the catch being taken.

2.6 Cameras On or Over the Field of Play

- 2.6.1 The on-field umpires shall be entitled to refer to the third umpire for a decision as to whether the ball has at any time during the normal course of play come into contact with any part of the camera, its apparatus or its cables above the playing area, as contemplated in clause 20.1.3.
- 2.6.2 Where an on-field umpire wishes to use the assistance of the third umpire in this circumstance, he/she shall communicate with the third umpire by use of a two-way radio and the third umpire shall convey his/her decision to the bowler's end umpire by the same method.
- 2.6.3 A decision shall be made immediately and cannot be changed thereafter. If the television evidence is inconclusive as to whether or not the ball has come into contact with any part of the camera, its apparatus or its cables above the playing area, the default presumption shall be in favour of no contact having been made.
- 2.6.4 The third umpire may initiate contact with the on-field umpire by two-way radio if TV coverage shows the ball to have been in contact with any part of the camera or its cables above the playing area as envisaged under this paragraph.

3 PLAYER REVIEW

The following paragraphs shall operate in addition to and in conjunction with paragraph 2 (Umpire Review).

3.1 Circumstances in which a Player Review may be requested

- 3.1.1 A player may request a review of any decision taken by the on-field umpires concerning whether or not a batter is dismissed, with the exception of 'Timed Out' (Player Review).
- 3.1.2 No other decisions made by the umpires are eligible for a Player Review with the exception of Fair Catch/Bump Ball (even after the third umpire has been consulted and the decision communicated).
- 3.1.3 Only the batter involved in a dismissal may request a Player Review of an Out decision and only the captain (or acting captain) of the fielding team may request a Player Review of a Not out decision.
- 3.1.4 A decision concerning whether or not a batter is dismissed that could have been the subject of a Umpire Review under paragraph 2 is eligible for a Player Review as soon as it is clear that the on-field umpire has chosen not to initiate the Umpire Review.

3.2 The manner of requesting the Player Review

- 3.2.1 The request shall be made by the player making a 'T' sign with both forearms at head height.
- 3.2.2 The total time elapsed between the ball becoming dead and the review request being made shall be no more than 15 seconds. The only exception permitted shall be when an Umpire Review for Fair Catch or Bump Ball (as permitted in paragraph 2.2 above) is required to answer an appeal for a caught decision, in which case either team is able to request a Player Review of that caught decision

within 15 seconds of the decision being communicated. The bowler's end umpire shall provide the relevant player with a prompt after 10 seconds if the request has not been made at that time and the player shall request the review immediately thereafter. If the on-field umpires believe that a request has not been made within the 15 second time limit, they shall decline the request for a Player Review.

- 3.2.3 The captain may consult with the bowler and other fielders, and the two batters may consult with each other prior to deciding whether to request a Player Review. Under no circumstances is any player permitted to query an umpire about any aspect of a decision before deciding on whether or not to request a Player Review. If the on-field umpires believe that the captain or either batter has received direct or indirect input emanating other than from the players on the field, then they may at their discretion decline the request for a Player Review. In particular, signals from the dressing room must not be given.
- 3.2.4 No replays, either at normal speed or slow motion, shall be shown on a big screen to spectators until the 15 second time limit allowed for requesting a Player Review has elapsed. The only exception to this provision is where a Player Review of a caught decision is requested after the Umpire Review of a Fair Catch or Bump Ball has concluded, as detailed in paragraph 3.2.2 above (due to the fact that replays may have been shown on the big screen during that Umpire Review process).
- 3.2.5 Where either on-field umpire initiates an Umpire Review, this does not preclude a player seeking a Player Review of a separate incident from the same delivery. The request for a Player Review may be made after the Umpire Review, provided the request is still within the 15 second time limit described in paragraph 3.2.2 above. (See paragraphs 3.9.2 and 3.9.3 below for the process for addressing both an Umpire and Player Review).
- 3.2.6 A request for a Player Review cannot be withdrawn once it has been made.

3.3 The process of consultation

- 3.3.1 On receipt of an eligible and timely request for a Player Review, the relevant on-field umpire shall make the sign of a shape of a TV screen with his/her hands in the normal way.
- 3.3.2 The relevant on-field umpire shall initiate communication with the third umpire by confirming;
- 3.3.2.1 That a Player Review has been requested,
- 3.3.2.2 The mode of dismissal for which the relevant on-field umpire adjudicated the appeal,
- 3.3.2.3 The decision that has been made (Out or Not out), and;
- 3.3.2.4 For LBW appeals, where relevant, if the bowler's end umpire believed that the striker made no genuine attempt to play the ball with the bat (the default presumption of the third umpire in the absence of any information on this point from the bowler's end umpire shall be that a genuine attempt to play the ball with the bat was made).

- 3.3.3 A two-way consultation process shall begin to investigate whether there is anything that the third umpire can see or hear which would indicate that the on-field umpire should change his/her original decision.
- 3.3.4 The third umpire shall not withhold any factual information which may help in the decision making process. In particular, in reviewing a dismissal, if the third umpire believes that the batter may instead be Out by any other mode of dismissal, he/she shall advise the on-field umpire accordingly. The process of consultation described in this paragraph in respect of such other mode of dismissal shall then be conducted as if the batter has been given Not out.
- 3.3.5 The third umpire shall initially check all modes of No ball except for the bowler using an Illegal Bowling Action (subject to the proviso that the third umpire may review whether the bowler has used a prohibited Specific Variation under Article 6.2 of the Illegal Bowling Regulations), where appropriate advising the on-field umpire accordingly.
- 3.3.6 If despite the available technology, the third umpire is unable to decide with a high degree of confidence whether the original on-field decision should be changed, then he/she shall report that the replays are 'inconclusive', and that the on-field decision shall stand. The third umpire shall not give answers conveying likelihoods or probabilities.
- 3.3.7 In circumstances where the television technology (all or parts thereof) is not available to the third umpire or fails for whatever reason, the third umpire shall advise the on-field umpire of this fact but still provide any relevant factual information that may be ascertained from the available television replays and other technology.
- 3.3.8 The on-field umpire shall then make his/her decision based on the information provided by the third umpire, any other factual information offered by the third umpire and his/her recollection and opinion of the original incident.
- 3.3.9 The on-field umpire shall reverse his/her decision if the nature of the supplementary information received from the third umpire leads him/her to conclude that his/her original decision was incorrect.

3.4 Review of LBW Decisions

- 3.4.1 In assessing whether a batter is Out LBW in accordance with clause 36, the third umpire shall first judge whether the delivery is fair (as set out in clause 36.1.1), and second, whether or not the ball has touched the bat before being intercepted by any part of the striker's person (as set out in clause 36.1.3).
- 3.4.2 If the batter is still eligible to be Out, the ball-tracking technology shall then present three pieces of information to the third umpire relating to the path of the ball:
- 3.4.2.1 The point of pitching (where applicable) (PITCHING).
- 3.4.2.2 The position of the ball at the point of first interception (IMPACT).
- 3.4.2.3 Whether the ball would have hit the wicket (WICKET).

- 3.4.3 This Decision Review System (DRS) and Third Umpire Protocol includes a category of Umpire's Call, which shall be the conclusion reported where the technology indicates a marginal decision in respect of either the point of first interception or whether the ball would have hit the stumps.

3.4.4 PITCHING

- 3.4.4.1 The interpretation of "pitches in line between wicket and wicket" in clause 36.1.2 shall refer to the position of the centre of the ball at the point of pitching, in relation to the Pitching Zone.
- 3.4.4.2 The Pitching Zone is defined as a two dimensional area on the pitch between both sets of stumps with its boundaries consisting of the base of both sets of stumps and a line between the outside of the outer stumps at each end.
- 3.4.4.3 Where applicable, the ball-tracking technology shall report that the ball pitched in one of the following three areas in relation to the Pitching Zone:

In Line	The centre of the ball was inside the Pitching Zone.
Outside Off	The centre of the ball was outside, and to the off side of, the Pitching Zone.
Outside Leg	The centre of the ball was outside, and to the leg side of, the Pitching Zone.

- 3.4.4.4 Subject to the satisfaction of the other elements of clause 36, the batter can be Out if the ball-tracking technology reports that the ball pitched Outside Off or In Line, but the batter shall be Not out if the ball pitched Outside Leg.

3.4.5 IMPACT

- 3.4.5.1 The interpretation of "the (first) point of impact, even if in above the level of the bails, is between wicket and wicket" in clause 36.1.4 shall refer to the position of the ball at the point of first interception, in relation to the Impact Zone.
- 3.4.5.2 The Impact Zone is defined as a three dimensional space extending between both wickets to an indefinite height and with its boundaries consisting of a line between the outside of the outer stumps at each end.

- 3.4.5.3 The ball-tracking technology shall report that the point of first interception was in one of the following categories in relation to the Impact Zone:

In Line	The centre of the ball was inside the Impact Zone.
Umpire's Call	Some part of the ball was inside the Impact Zone, but the centre of the ball was outside the Impact Zone, with the further sub-category of 'Umpire's Call (off side)' where the centre of the ball was to the off side of the Impact Zone and the bowler's end umpire communicates to the third umpire that no genuine attempt to play the ball was made by the batter.
Outside	No part of the ball was inside the Impact Zone, with the further sub-categories of 'Outside (off)' and 'Outside (leg)' to indicate the location of the point of first interception in relation to the Impact Zone when the bowler's end umpire communicates to the third umpire that no genuine attempt to play the ball was made by the batter.

- 3.4.5.4 Where a Not out decision is being reviewed, and it is judged that the batter has made a genuine attempt to play the ball, the ball-tracking technology must report that the point of first interception was In Line for the batter to be eligible to be given Out, otherwise the batter shall remain Not out.
- 3.4.5.5 Where a Not out decision is being reviewed, and it is judged that the batter has made no genuine attempt to play the ball, the ball-tracking technology must report that the point of impact was In Line, or Umpire's Call (off side), or Outside (off) for the batter to be eligible to be given Out, otherwise the batter shall remain Not out.
- 3.4.5.6 Where an Out decision is being reviewed, and it is judged that the batter has made a genuine attempt to play the ball, the ball-tracking technology must report that the point of first interception was Outside for the decision to be reversed to Not out, otherwise the batter shall remain eligible to be given Out.
- 3.4.5.7 Where an Out decision is being reviewed, and it is judged that the batter has made no genuine attempt to play the ball, the ball-tracking technology must report that the point of first interception was Outside (leg) for the decision to be reversed to Not out, otherwise the batter shall remain eligible to be given Out.

3.4.6 WICKET

- 3.4.6.1 The interpretation of whether "the ball would have hit the wicket" in clause 36.15 shall refer to the position of the ball as it either hits or passes the wicket, in relation to the Wicket Zone.
- 3.4.6.2 The Wicket Zone is defined as a two dimensional area whose boundaries are the outside of the outer stumps, the base of the stumps and the bottom of the bails.

- 3.4.6.3 The ball-tracking technology shall report whether the ball would have hit the wicket with reference to the following three categories:

Hitting	The ball was hitting the wicket, and the centre of the ball was inside the Wicket Zone.
Umpire's Call	The ball was hitting the wicket, but the centre of the ball was not inside the Wicket Zone.
Missing	The ball was missing the wicket.

- 3.4.6.4 Where a Not out decision is being reviewed, the ball-tracking technology must report that the ball was Hitting for the batter to be eligible to be given Out, otherwise the batter shall remain Not out.

However, where the evidence shows that the ball was Hitting, the point of first interception was In Line, and the ball pitched In Line or Outside Off, but that:

- The point of first interception was 300cm or more from the stumps; or
- The point of first interception was more than 250cm but less than 300cm from the stumps and the distance between the point of pitching and the point of first interception was less than 40cm,

the on-field decision shall stand (that is, Not out).

- 3.4.6.5 Where an Out decision is being reviewed, the ball-tracking technology must report that the ball was Missing for the on-field decision to be reversed to Not out, otherwise the batter shall remain eligible to be given Out.

- 3.4.7 When the ball strikes the batter on the full, and the evidence provided by the ball-tracking technology indicates that the ball would have pitched before striking or passing the wicket, there will be no information available from that delivery that will allow the ball-tracking technology to accurately predict the height of the ball after pitching.
- 3.4.8 With regard to determining whether the ball would have hit the wicket under these circumstances, the ball-tracking technology shall project the line of the ball in accordance with clause 36.2.3 (it is to be assumed that the path of the ball before interception would have continued after interception, irrespective of whether the ball might have pitched subsequently or not), and display the simulated path of the ball from directly above the wicket.
- 3.4.9 The third umpire shall advise the bowler's end umpire only on the point of first interception and whether the ball would have hit the stumps (in line with the process set out in paragraph 3.4 above), but shall make no comment on the predicted height of the ball after pitching, which shall remain a judgment of the bowler's end umpire.

3.5 The process for communicating the final decision

- 3.5.1 For Player Reviews concerning potential dismissals, the relevant on-field umpire shall indicate Out by raising his/her finger above his/her head in a normal yet prominent manner or indicate Not out by the call of 'not out' and by crossing his/her hands in a horizontal position side to side in front and above his/her waist three times. Where the decision is a reversal of the on-field umpire's previous decision, he/she shall make the 'revoke last signal' indication immediately prior to the above.
- 3.5.2 If the mode of dismissal is not obvious or not the same as that on which the original decision was based, then the umpire shall advise the scorers via the third umpire.

3.6 Number of Player Review requests permitted

- 3.6.1 In each innings, each team shall be allowed to make a maximum of one Player Review request that is categorised as 'Unsuccessful' (as set out in paragraph 3.6.3 below).
- 3.6.2 Where a request for a Player Review results in the original on-field decision being reversed, then the Player Review shall be categorised as 'Successful' and shall not count towards the innings limit.
- 3.6.3 Where a request for a Player Review results in the original on-field decision remaining unchanged (other than in the circumstances set out in paragraphs 3.6.4, 3.6.6 or 3.6.8), the Player Review shall be categorised as 'Unsuccessful'.
- 3.6.4 Where a request for a Player Review of an LBW decision results in the on-field decision remaining unchanged solely on the basis of an Umpire's Call, the Player Review shall be categorised as 'Unchanged – Umpire's Call'. A Player Review categorised as 'Unchanged – Umpire's Call' shall not count towards the innings limit set out in paragraph 3.6.1.
- 3.6.5 Where, following a request for a Player Review, the original on-field decision of Out is unchanged, but for a different mode of dismissal from the original on-field decision, then the Player Review shall still be categorised as 'Unsuccessful'.
- 3.6.6 Where, following a request for a Player Review, the original on-field decision of Not out is unchanged on account of the delivery being a No ball (for any reason), thereby not requiring any further evaluation, the Player Review shall not be counted as 'Unsuccessful' and accordingly shall not count towards the innings limit set out in paragraph 3.6.1.
- 3.6.7 Where a Player Review and an Umpire Review are requested from the same delivery and the decision of the third umpire from the Umpire Review renders the Player Review unnecessary (see paragraphs 3.9.2 and 3.9.3), the Player Review request shall be disregarded and accordingly shall not count towards the innings limit set out in paragraph 3.6.1.

- 3.6.8 A Player Review categorised as 'Unsuccessful' may be reinstated by the ICC Match Referee at his/her sole discretion (if appropriate after consultation with the ICC Technical Official and/or the television broadcast director) if the Player Review could not properly be concluded due to a failure of the technology. Any such decision shall be final and shall be taken as soon as possible, being communicated to both teams once all the relevant facts have been ascertained by the ICC Match Referee. A Player Review categorised as 'Unsuccessful' shall not be reinstated if, despite any technical failures, the correct decision could still have been made using the other available technology. Similarly, a Player Review categorised as 'Unsuccessful' shall not be reinstated where the technology worked as intended, but the evidence gleaned from its use was inconclusive.
- 3.6.9 The third umpire shall be responsible for counting the number Player Reviews categorised as 'Unsuccessful' and shall advise the on-field umpires once either team has exhausted their allowance for the innings.
- 3.6.10 The scoreboard shall display, for the innings in progress, the number of Player Reviews remaining available to each team.

CATEGORY OF PLAYER REVIEW	OUTCOME OF PLAYER REVIEW	CONSEQUENCE OF PLAYER REVIEW
Successful (paragraph 3.6.2)	On-field decision reversed	Does not count towards innings limit set out in paragraph 3.6.1
Unsuccessful (paragraphs 3.6.3 and 3.6.5)	On-field decision unchanged	Counts towards innings limit set out in paragraph 3.6.1
Unchanged – Umpire's Call (paragraph 3.6.4)	On-field decision unchanged	Does not count towards innings limit set out in paragraph 3.6.1
No ball – no evaluation required (paragraph 3.6.6)	On-field decision unchanged	Does not count towards innings limit set out in paragraph 3.6.1
Failure of technology (paragraph 3.6.8)	On-field decision unchanged	Does not count towards innings limit set out in paragraph 3.6.1

3.7 Dead ball

- 3.7.1 If following a Player Review request, an original decision of Out is changed to Not out, then the ball is still deemed to have become dead when the original decision was made (as per clause 20.11.3). The batting side, while benefiting from the reversal of the dismissal, shall not benefit from any runs that may subsequently have accrued from the delivery had the on-field umpire originally made a Not out decision, other than any No ball penalty that could arise under paragraph 3.3.5 above.
- 3.7.2 If an original decision of Not out is changed to Out, the ball shall retrospectively be deemed to have become dead from the moment of the dismissal event. All subsequent events, including any runs scored, shall be ignored.

3.8 Use of technology

- 3.8.1 The following technology may be used by the third umpire during a Player Review:
- 3.8.1.1 Replays, at any speed, from any available broadcast camera
 - 3.8.1.2 Sound from the stump microphones with the replays at normal speed and slow motion
 - 3.8.1.3 Approved ball-tracking technology:
 - HawkEye (HawkEye Innovations), or;
 - VirtualEye (ARL)
 - 3.8.1.4 Approved sound-based edge detection technology:
 - Real-Time Snickometer (BBG Sports), or;
 - UltraEdge (HawkEye Innovations)
 - 3.8.1.5 Approved heat-based edge detection technology:
 - Hot Spot cameras (BBG Sports)
 - 3.8.1.6 LED Wickets (using the lights to indicate if the wicket is broken, as set out in paragraph 4.2):
 - Zing Bails and Stumps
- 3.8.2 In addition, other forms of technology may be used subject to the ICC being satisfied that the required standards of accuracy and time efficiency can be met.
- 3.8.3 Where practical usage or further testing indicates that any of the above forms of technology cannot reliably provide accurate and timely information, then it may be removed prior to or during a match. The final decision regarding the technology to be used in a given match shall be taken by the ICC Match Referee in consultation with the ICC Technical Official, ICC management and the competing teams' governing bodies.

3.9 Combining Umpire Review with Player Review

- 3.9.1 If an Umpire Review (under paragraph 2) and a request for a Player Review (under paragraph 3) are made following the same delivery but relating to separate modes of dismissal, the following process shall apply.
- 3.9.2 The Umpire Review shall be carried out prior to the Player Review if all of the following conditions apply:
- 3.9.2.1 The Player Review has been requested by the fielding side.
 - 3.9.2.2 The Umpire Review and the Player Review both relate to the dismissal of the same batter.
 - 3.9.2.3 If the batter is out, the number of runs scored from the delivery would be the same for both modes of dismissal.
 - 3.9.2.4 If the batter is out, the batter on strike for the next delivery would be the same for both modes of dismissal.

- 3.9.3 If the Umpire Review leads the third umpire to make a decision of Out, then this shall be displayed in the usual manner and the Player Review shall not be undertaken. If the Umpire Review results in a Not out decision, then the third umpire shall make no public decision but shall proceed to address the request for a Player Review.
- 3.9.4 For illustration, following an LBW appeal which is given Not out by the bowler's end umpire, the striker sets off for a run, is sent back and there is an appeal for her run out. The players request that the LBW decision is reviewed and the umpires request that the run out be reviewed. The four criteria above are satisfied, so the run out referral is determined first. Should the appeal for run out be Out, then there is no requirement for the LBW review to take place.
- 3.9.5 In all other circumstances, the incidents shall be addressed in chronological order. If the conclusion from the first incident is that a batter is dismissed, then the ball would be deemed to have become dead at that point, rendering investigation of the second incident unnecessary.

4 INTERPRETATION OF PLAYING CONDITIONS

- 4.1 When using a replay to determine the moment at which the wicket has been put down (as per clause 29.1), the third umpire shall deem this to be the first frame in which one of the bails is shown (or can be deduced) to have lost all contact with the top of the stumps and subsequent frames show the bail permanently removed from the top of the stumps.
- 4.2 Where LED Wickets are used (as provided for in paragraph 3.8.1.6) the moment at which the wicket has been put down (as per clause 29.1) shall be deemed to be the first frame in which the LED lights are illuminated and subsequent frames show the bail permanently removed from the top of the stumps.

APPENDIX E

CALCULATIONS

Table 1: Calculation sheet for use when a delay or interruptions occur in the First Innings

Time

Net playing time available at start of the match	380 minutes	(A)
Time innings in progress	_____	(B)
Playing time lost	_____	(C)
Extra time available	_____	(D)
Time made up from reduced interval	_____	(E)
Effective playing time lost [C – (D + E)]	_____	(F)
Remaining playing time available (A – F)	_____	(G)
G divided by 3.8 (to 2 decimal places)	_____	(H)
Max overs per team [H/2] (round up fractions)	_____	(I)
Maximum overs per bowler [I/5]	_____	
Duration of Powerplay Overs (initial, batting side)	_____ + _____	

Rescheduled Playing Hours

First session to commence or recommence	_____	(J)
Length of innings [I x 3.8] (round up fractions)	_____	(K)
Rescheduled first innings cessation time [J + (K – B)]	_____	(L)
Length of interval	_____	(M)
Second innings commencement time [L + M]	_____	(N)
Rescheduled second innings cessation time [N + K]	_____	*(O)

* Ensure that the match is not finishing earlier than the original or rescheduled cessation time by applying clause 13.7.2. If so, add at least one over to each team and recalculate (I) to (O) above to prevent this from happening.

Table 2: Calculation sheet to check whether an interruption during the First Innings should terminate the innings

Proposed re-start time	_____	(P)
Rescheduled cut-off time allowing for full use of any extra time provision	_____	(Q)
Minutes between P and Q	_____	(R)
Potential overs to be bowled [R/3.8] (round up fractions)	_____	(S)
Number of complete overs faced to date in first innings	_____	(T)
If S is greater than T then revert to Table 1		
If S is less than or equal to T then the first innings is terminated – go to Table 3		

Table 3: Calculation sheet for the start of the Second Innings

Maximum overs to be bowled:

(If first innings was terminated, S from Table 2)	_____	(A)
Scheduled length of innings: [A x 3.8] (round up fractions)	_____	(B)
Start time	_____	(C)
Scheduled cessation time [C + B]	_____	(D)

Overs per bowler and fielding restrictions

Maximum overs per bowler [A/5]	_____	overs
Duration of Powerplay overs (initial, batting side)	_____ + _____	overs

Table 4: Calculation sheet for use when interruption occurs after the start of the Second Innings

Time

Time at start of innings	_____	(A)
Time at start of interruption	_____	(B)
Time innings in progress	_____	(C)
Restart time	_____	(D)
Length of interruption [D – B]	_____	(E)
Additional time available:	_____	(F)
(Any unused provision for 'Extra Time' or for earlier than scheduled start of second innings)		
Total playing time lost [E – F]	_____	(G)

Overs

Maximum overs at start of innings	_____	(H)
Overs lost [G/3.8] (rounded down)	_____	(I)
Adjusted maximum length of innings [H – I]	_____	(J)
Rescheduled length of innings [J x 3.8 rounded up]	_____	(K)
Amended cessation time of innings [D + (K – C)]	_____	(L)

Overs per bowler and Fielding Restrictions

Maximum overs per bowler [J/5]	_____	overs
Duration of Powerplay overs (initial, batting side)	_____ + _____	overs

APPENDIX F

USE OF ELECTRONIC COMMUNICATIONS EQUIPMENT

The use of electronic communication devices and equipment of any kind to communicate with players on the field of play shall not be permitted.

ICC WOMEN'S TWENTY20 INTERNATIONAL PLAYING CONDITIONS

Effective from 1 September 2019

ICC WOMEN'S TWENTY20 INTERNATIONAL PLAYING CONDITIONS

Effective 1 September 2019, the following changes shall be applied to these playing conditions for 'Green' status Members.

- Clause 1.2** Nomination and replacement of players
Replace ICC Match Referee with umpires
- Clause 1.3** Captain
1.3.5 Replace ICC Match Referee with umpires
- Clause 2.1** Umpires appointment and attendance shall apply subject to the following:
- 2.1.2.1 The Home Board shall appoint both on-field umpires, a reserve umpire is optional.
- 2.1.3 Shall not apply
- 2.1.4.1 Shall not apply and shall be replaced by the following:
The Home Board shall appoint the umpires from its own panel
- 2.1.5 Shall not apply
- 2.1.6 Remove reference to ICC Match Referee
- Clause 2.3** Consultation with Home Board
Before the match the umpires shall consult with the Home Board / Ground Authority
- Clause 2.8** Suspension of play in dangerous or unreasonable circumstances
Shall apply subject to the following:
Remove reference to ICC Match Referee
- 2.8.5 If light meters are available to the Home Board they shall be used.
- 2.8.6 Shall only apply to venues where the artificial lights are of sufficient standard
- 2.8.9 Replace ICC Match Referee with umpires
- Clause 4.2** Approval and control of balls
- 4.2.1 Remove reference to Kookaburra Turf or its equivalent.
- 4.2.2 Replace at least 6 new balls with at least 4 new balls
- Clause 6.3** Selection and preparation of the pitch
- 6.3.2 Onfield umpires if there is no reserve umpire
- 6.3.3 Replace ICC Match Referee with umpires
- Clause 6.4** Changing the pitch
Replace ICC Match Referee with umpires
- Clause 6.5** Non turf pitches
Shall be replaced by the following:
All T20I matches shall be played on natural turf or artificial pitches. The use of PVA and other adhesives in the preparation of turf pitches is not permitted.
- Clause 9** Preparation and Maintenance of the Playing surface
Shall apply to turf pitches only except 9.1.5 and 9.1.6 which may also apply to artificial pitches
- 9.8 Remove reference to ICC Match Referee

Clause 10.2	Covering the pitch during the match Shall only apply if covers are available
Clause 10.3	Removal of covers Shall only apply if covers are available
Clause 13.4	The Toss Replace ICC Match Referee with umpires
Clause 16.2	ICC Match Referee awarding a match All references to ICC Match Referee shall be replaced by umpires
Clause 19.1	
19.1.4	Determining the boundary of the field of play Shall not apply and shall be replaced by: Any venue that cannot meet the minimum boundary sizes can apply to the ICC to be considered for an exemption.
Clause 19.2	Identifying and marking the boundary Reference to rope may not apply
Clause 21.2	Fair delivery – the arm Remove reference to ICC Match Referee
Clause 21.3	Ball thrown or delivered underarm – action by umpires
21.3.3	Replace ICC Match Referee with ICC Umpires and Referees Department
Clause 40.1	Out Timed Out
40.1.3	Clause 16.2 Awarding a match
Clause 41	
41.1 to 41.19	Unfair Play Replace ICC Match Referee with ICC Umpires and Referees Department
Clause 42	Players conduct Replace ICC Match Referee with ICC Umpires and Referees Department
Appendix A	
Clause 9.8	Replace ICC Match Referee with umpires
Appendix B	
Clause 2	The Wickets Provisions must be made to place stumps into the ground, spring loaded stumps or use of bases are not permitted
Appendix C	
Clause 3.3.1	Used of sightscreens is not mandatory but if they are used they must be provided at both ends of the ground.
Appendix F	
Clause 1	Procedure for the Super Over Replace ICC Match Referee with umpires. The umpires' decision shall be final.
Clause 3	Remove reference to ICC Match Referee

ICC WOMEN'S TWENTY20 INTERNATIONAL PLAYING CONDITIONS

CONTENTS

1	THE PLAYERS	9.5
2	THE UMPIRES	9.8
3	THE SCORERS	9.13
4	THE BALL	9.14
5	THE BAT	9.14
6	THE PITCH	9.16
7	THE CREASES	9.18
8	THE WICKETS	9.19
9	PREPARATION AND MAINTENANCE OF THE PLAYING AREA	9.20
10	COVERING THE PITCH	9.22
11	INTERVALS	9.22
12	START OF PLAY; CESSATION OF PLAY	9.23
13	INNINGS	9.25
14	THE FOLLOW-ON	9.29
15	DECLARATION AND FORFEITURE	9.29
16	THE RESULT	9.29
17	THE OVER	9.32
18	SCORING RUNS	9.33
19	BOUNDARIES	9.37
20	DEAD BALL	9.39
21	NO BALL	9.41
22	WIDE BALL	9.45
23	BYE AND LEG BYE	9.46
24	FIELDER'S ABSENCE; SUBSTITUTES	9.48
25	BATTER'S INNINGS	9.50
26	PRACTICE ON THE FIELD	9.51
27	THE WICKET-KEEPER	9.52
28	THE FIELDER	9.54
29	THE WICKET IS DOWN	9.57
30	BATTER OUT OF HER GROUND	9.58
31	APPEALS	9.59
32	BOWLED	9.60
33	CAUGHT	9.61
34	HIT THE BALL TWICE	9.62
35	HIT WICKET	9.63
36	LEG BEFORE WICKET	9.63
37	OBSTRUCTING THE FIELD	9.64
38	RUN OUT	9.66

39	STUMPED	9.67
40	TIMED OUT	9.67
41	UNFAIR PLAY	9.68
42	PLAYERS' CONDUCT	9.80

APPENDIX A DEFINITIONS 9.84

1	The match	9.84
2	Implements and equipment	9.84
3	The playing area	9.85
4	Positioning	9.85
5	Umpires and decision-making	9.86
6	Batters	9.87
7	Fielders	9.88
8	Substitutes and Concussion Replacements	9.88
9	Bowlers	9.88
10	The ball	9.89
11	Runs	9.89
12	The person	9.89
13	Off side/on side; in front of/behind the popping crease.	9.90

APPENDIX B EQUIPMENT 9.91

1	The Bat	9.91
2	The wickets	9.94
3	Wicket-keeping gloves	9.95

APPENDIX C THE VENUE 9.96

1	The pitch and the creases	9.96
2	Restriction on the placement of fielders	9.97
3	Advertising on grounds, perimeter boards and sight-screens	9.98
4	Markings on outfield	9.98

**APPENDIX D DECISION REVIEW SYSTEM (DRS)
AND THIRD UMPIRE PROTOCOL** 9.99

1	General	9.99
2	Umpire Review	9.101
3	Player Review	9.104
4	Interpretation of Playing Conditions	9.113

APPENDIX E CALCULATIONS 9.114

APPENDIX F PROCEDURE FOR THE SUPER OVER 9.117

APPENDIX G USE OF ELECTRONIC COMMUNICATIONS EQUIPMENT 9.120

PREAMBLE THE SPIRIT OF CRICKET

Cricket owes much of its appeal and enjoyment to the fact that it should be played not only according to the Laws (which are incorporated within these Playing Conditions), but also within the Spirit of Cricket.

The major responsibility for ensuring fair play rests with the captains, but extends to all players, match officials and, especially in junior cricket, teachers, coaches and parents.

Respect is central to the Spirit of Cricket.

Respect your captain, team-mates, opponents and the authority of the umpires.

Play hard and play fair.

Accept the umpire's decision.

Create a positive atmosphere by your own conduct, and encourage others to do likewise.

Show self-discipline, even when things go against you.

Congratulate the opposition on their successes, and enjoy those of your own team.

Thank the officials and your opposition at the end of the match, whatever the result.

Cricket is an exciting game that encourages leadership, friendship and teamwork, which brings together people from different nationalities, cultures and religions, especially when played within the Spirit of Cricket.

1 THE PLAYERS

1.1 Number of players

A match is played between two sides, each of eleven players, one of whom shall be captain.

1.2 Nomination and replacement of players

1.2.1 Each captain shall nominate 11 players plus a maximum of 4 substitute fielders in writing to the ICC Match Referee before the toss. Other than set out in clause 1.2.7, no player (member of the playing eleven) may be changed after the nomination without the consent of the opposing captain.

1.2.2 Only those nominated as substitute fielders shall be entitled to act as substitute fielders during the match, unless the ICC Match Referee, in exceptional circumstances, allows subsequent additions.

1.2.3 All those nominated including those nominated as substitute fielders, as well as any Concussion Replacements, must be eligible to play for that particular team and by such nomination the nominees shall warrant that they are so eligible.

1.2.4 In addition, by their nomination, the nominees shall be deemed to have agreed to abide by all the applicable ICC Regulations pertaining to international cricket and in particular, the Clothing and Equipment Regulations, the Code of Conduct for Players and Player Support Personnel (hereafter referred to as the ICC Code of Conduct), the Anti-Racism Code for Players and Player Support Personnel, the Anti-Doping Code and the Anti-Corruption Code.

- 1.2.5 A player or player support personnel who has been suspended from participating in a match shall not, from the toss of the coin and for the remainder of the match thereafter:
- 1.2.5.1 Be nominated as, or carry out any of the duties or responsibilities of a substitute fielder, or
- 1.2.5.2 Enter any part of the playing area (which shall include the field of play and the area between the boundary and the perimeter boards) at any time, including any scheduled or unscheduled breaks in play.
- 1.2.6 A player who has been suspended from participating in a match shall be permitted from the toss of the coin and for the remainder of the match thereafter be permitted to enter the players' dressing room provided that the players' dressing room (or any part thereof) for the match is not within the playing area described in clause 1.2.5.2 above (for example, the player is not permitted to enter the on-field 'dug-out').
- 1.2.7 If a player sustains a concussion or suspected concussion as a result of a head or neck injury during the course of the relevant match, a Concussion Replacement may be permitted in the following circumstances:
- 1.2.7.1 the head or neck injury must have been sustained during play and within the playing area described in clause 1.2.5.2 above;
- 1.2.7.2 a concussion or suspected concussion must have been formally diagnosed by the Team Medical Representative or in consultation with the Match Day Doctor;
- 1.2.7.3 the Team Medical Representative or Team Manager shall submit a Concussion Replacement Request to the ICC Match Referee on a standard form, which shall:
- 1.2.7.3.1 identify the player who has sustained the concussion or suspected concussion;
- 1.2.7.3.2 specify the incident in which the concussion or suspected concussion was sustained, including the time at which it occurred;
- 1.2.7.3.3 confirm that, following an examination, the Team Medical Representative, or in consultation with the Match Day Doctor, believes or suspects that the player has sustained a concussion as a result of the incident specified in 1.2.7.3.2 above; and
- 1.2.7.3.4 identify the requested Concussion Replacement, who shall be a like-for-like replacement for the player who has sustained the concussion or suspected concussion.
- 1.2.7.4 The Concussion Replacement Request must be submitted as soon as possible after the incident specified in 1.2.7.3.2 if a Concussion Replacement is to be permitted.

- 1.2.8 The ICC Match Referee should ordinarily approve a Concussion Replacement Request if the replacement is a like-for-like player whose inclusion will not excessively advantage her team for the remainder of the match.
- 1.2.8.1 In assessing whether the nominated Concussion Replacement should be considered a like-for-like player, the ICC Match Referee should consider the likely role the concussed player would have played during the remainder of the match, and the normal role that would be performed by the nominated Concussion Replacement.
- 1.2.8.2 If the ICC Match Referee believes that the inclusion of the nominated Concussion Replacement, when performing their normal role, would excessively advantage their team, the Match Referee may impose such conditions upon the identity and involvement of the Concussion Replacement as he/she sees fit, in line with the overriding objective of facilitating a like-for-like replacement for the concussed player.
- 1.2.8.3 The ICC Match Referee may, in reviewing a Concussion Replacement Request made in accordance with clause 1.2.7.3, request any such further information as may be required in order to make the determination required under clauses 1.2.8.1 and 1.2.8.2.
- 1.2.9 The decision of the ICC Match Referee in relation to any Concussion Replacement Request shall be final and neither team shall have any right of appeal.
- 1.2.10 Once the Concussion Replacement has been approved by the ICC Match Referee, the replaced player shall play no further part in the match.
- 1.2.11 Both the Concussion Replacement and the replaced player shall be considered to have played in the match for records and statistical purposes.
- 1.3 Captain**
- 1.3.1 If at any time the captain is not available, a deputy shall act for her.
- 1.3.2 If a captain is not available to nominate the players, then any person associated with that team may act as her deputy to do so. See clause 1.2.
- 1.3.3 At any time after the nomination of the players, only a nominated player can act as deputy in discharging the duties and responsibilities of the captain as stated in these Playing Conditions, including at the toss. See clause 13.4 (The toss).
- 1.4 Responsibility of captains**
- The captains are responsible at all times for ensuring that play is conducted within The Spirit of Cricket as well as within these Playing Conditions.

2 THE UMPIRES**2.1 Appointment and attendance**

The following rules for the selection and appointment of umpires shall be followed as far as it is practicable to do so:

- 2.1.1 The umpires shall control the game as required by these Playing Conditions, with absolute impartiality and shall be present at the ground at least 90 minutes before the scheduled start of play.
- 2.1.2 The Home Board shall appoint all umpires to stand in each match in the following manner:
 - 2.1.2.1 For non-televised matches the Home Board shall appoint two on-field umpires and a reserve umpire. The responsibility of the reserve umpire will be to act as an emergency on-field umpire and carry out tasks as prescribed for the third and fourth umpires. (note: a fourth umpire is not required.)
 - 2.1.2.2 For televised matches where DRS is not used, the Home Board shall appoint two on-field umpires and a third umpire. The third umpire shall act as the emergency on-field umpire and officiate in regard to TV replays.
 - 2.1.2.3 For televised matches where DRS is used, the Home Board shall appoint two on-field umpires, a third umpire who shall officiate in regard to the DRS and a reserve (fourth) umpire. The reserve (fourth) umpire shall act as the emergency on-field umpire (not the third umpire).
- 2.1.3 As early as possible before each match, the Home Board will advise the ICC of the names of its appointees and will advise the Manager of the visiting team of all umpires' names.
- 2.1.4 It's recommended that in T20I matches the Home Board shall appoint match officials in the following manner:
 - 2.1.4.1 For all matches, only 'Elite Panel', 'International Panel', 'First Class Panel' or female umpires on the 'ICC Development Panel' shall be appointed as the on-field umpires or reserve umpire.
 - 2.1.4.2 For televised matches where DRS is not used, only 'Elite Panel', 'International Panel' or 'First Class Panel' umpires shall be appointed as the third umpire.
 - 2.1.4.3 For televised matches where DRS is used, only 'Elite Panel' or 'International Panel' umpires shall be appointed as the third umpire.
 - 2.1.4.4 The playing conditions governing the use of the DRS and the third umpire are included in Appendix D.
- 2.1.5 The Home Board shall appoint a local match referee for all matches (ICC Match Referee) from its International Panel of ICC Match Referees.
- 2.1.6 Neither team will have a right of objection to the appointment of any umpire or ICC Match Referee.

2.2 Change of umpire

An umpire shall not be changed during the match, other than in exceptional circumstances, unless he/she is injured or ill.

2.3 Consultation with Home Board

Before the match the umpires shall consult with the Home Board to determine;

- 2.3.1 the balls to be used during the match. See clause 4 (The ball).
 - 2.3.2 the hours of play and the times and durations of any agreed intervals.
 - 2.3.3 which clock or watch and back-up time piece is to be used during the match.
 - 2.3.4 the boundary of the field of play. See clause 19 (Boundaries).
 - 2.3.5 the use of covers. See clause 10 (Covering the pitch).
 - 2.3.6 any special conditions of play affecting the conduct of the match.
- and inform the scorers of agreements in 2.3.2, 2.3.3, 2.3.4 and 2.3.6.

2.4 The wickets, creases and boundaries

Before the toss and during the match, the umpires shall satisfy themselves that

- 2.4.1 the wickets are properly pitched. See clause 8 (The wickets).
- 2.4.2 the creases are correctly marked. See clause 7 (The creases).
- 2.4.3 the boundary of the field of play complies with the requirements of clauses 19.1 (Determining the boundary of the field of play), 19.2 (Identifying and marking the boundary) and 19.3 (Restoring the boundary).

2.5 Conduct of the match, implements and equipment

Before the toss and during the match, the umpires shall satisfy themselves that

- 2.5.1 the conduct of the match is strictly in accordance with these Playing Conditions.
- 2.5.2 the implements used in the match conform to the following:
 - 2.5.2.1 clause 4 (The ball).
 - 2.5.2.2 externally visible requirements of clause 5 (The bat) and paragraph 1 of Appendix B.
 - 2.5.2.3 either clauses 8.2 (Size of stumps) and 8.3 (The bails).
- 2.5.3 no player uses equipment other than that permitted. See paragraph 2 of Appendix A. Note particularly therein the interpretation of 'protective helmet'.
- 2.5.4 the wicket-keeper's gloves comply with the requirements of clause 27.2 (Gloves).

2.6 Fair and unfair play

The umpires shall be the sole judges of fair and unfair play.

2.7 Fitness for play

2.7.1 It is solely for the umpires together to decide whether either conditions of ground, weather or light or exceptional circumstances mean that it would be dangerous or unreasonable for play to take place.

Conditions shall not be regarded as either dangerous or unreasonable merely because they are not ideal.

The fact that the grass and the ball are wet does not warrant the ground conditions being regarded as unreasonable or dangerous.

2.7.2 Conditions shall be regarded as dangerous if there is actual and foreseeable risk to the safety of any player or umpire.

2.7.3 Conditions shall be regarded as unreasonable if, although posing no risk to safety, it would not be sensible for play to proceed.

2.7.4 If the umpires consider the ground is so wet or slippery as to deprive the bowler of a reasonable foothold, the fielders of the power of free movement, or the batters of the ability to play their strokes or to run between the wickets, then these conditions shall be regarded as so bad that it would be dangerous and unreasonable for play to take place.

2.8 Suspension of play in dangerous or unreasonable circumstances

2.8.1 All references to ground include the pitch. See clause 6.1 (Area of pitch).

2.8.2 If at any time the umpires together agree that the conditions of ground, weather or light, or any other circumstances are dangerous or unreasonable, they shall immediately suspend play, or not allow play to start or to recommence. The decision as to whether conditions are so bad as to warrant such action is one for the umpires alone to make, following consultation with the ICC Match Referee.

2.8.3 If circumstances are warranted, the umpires shall stop play and instruct the Ground Authority to take whatever action they can and use whatever equipment is necessary to remove as much dew as possible from the outfield when conditions become unreasonable or dangerous. The umpires may also instruct the ground staff to take such action during scheduled and unscheduled breaks in play.

2.8.4 The umpires shall disregard any shadow on the pitch from the stadium or from any permanent object on the ground.

2.8.5 Light Meters

It is the responsibility of each Home Board to supply light meters to the match officials to be used in accordance with these playing conditions.

2.8.5.1 All light meters shall be uniformly calibrated.

2.8.5.2 The umpires shall be entitled to use light meter readings as a guideline for determining whether the light is fit for play in accordance with the criteria set out in clause 2.8.2 above.

2.8.5.3 Light meter readings may accordingly be used by the umpires:

2.8.5.3.1 To determine whether there has been at any stage a deterioration or improvement in the light.

2.8.5.3.2 As benchmarks for the remainder of a match.

2.8.6 Use of artificial lights

If in the opinion of the umpires, natural light is deteriorating to an unfit level, they shall authorize the Ground Authority to use the available artificial lighting so that the match can commence or continue in acceptable conditions.

In the event of power failure or lights malfunction, the provisions relating to the delay or interruption of play due to bad weather or light shall apply.

2.8.7 When there is a suspension of play it is the responsibility of the umpires to monitor conditions. They shall make inspections as often as appropriate, unaccompanied by any players or officials. Immediately the umpires together agree that the conditions are no longer dangerous or unreasonable they shall call upon the players to resume play.

2.8.8 The safety of all persons within the ground is of paramount importance to the ICC. In the event that of any threatening circumstance, whether actual or perceived (including for example weather, pitch invasions, act of God, etc.), then the umpires, on the advice of the ICC Match Referee, should suspend play and all players and officials should immediately be asked to leave the field of play in a safe and orderly manner and to relocate to a secure and safe area (depending on each particular threat) pending the satisfactory passing or resolution of such threat or risk to the reasonable satisfaction of the umpires, the ICC Match Referee, the head of the relevant Ground Authority, the head of ground security and/or the police as the circumstances may require.

2.8.9 Where play is suspended under clause 2.8.8 above the decision to abandon or resume play shall be the responsibility of the ICC Match Referee who shall act only after consultation with the head of ground security and the police.

2.9 Position of umpires

The umpires shall stand where they can best see any act upon which their decision may be required.

Subject to this over-riding consideration, the bowler's end umpire shall stand in a position so as not to interfere with either the bowler's run-up or the striker's view.

The striker's end umpire may elect to stand on the off side instead of the on side of the pitch, provided he/she informs the captain of the fielding side, the striker and the other umpire.

2.10 Umpires changing ends

Shall not apply.

2.11 Disagreement and dispute

Where there is disagreement or dispute about any matter, the umpires together shall make the final decision. See also clause 31.6 (Consultation by umpires).

2.12 Umpire's decision

An umpire may alter any decision provided that such alteration is made promptly. This apart, an umpire's decision, once made, is final.

2.13 Signals

2.13.1 The following code of signals shall be used by umpires.

2.13.1.1 Signals made while the ball is in play.

No ball – by extending one arm horizontally.

Out – by raising an index finger above the head.
(If not out, the umpire shall call Not out.)

Wide – by extending both arms horizontally.

Dead ball – by crossing and re-crossing the wrists below the waist.

2.13.1.2 When the ball is dead, the bowler's end umpire shall repeat the signals in clause 2.13.1.1, with the exception of the signal for Out, to the scorers.

2.13.1.3 The signals listed below shall be made to the scorers only when the ball is dead.

Boundary 4 – by waving an arm from side to side finishing with the arm across the chest.

Boundary 6 – by raising both arms above the head.

Bye – by raising an open hand above the head.

Five Penalty runs awarded to the batting side – by repeated tapping of one shoulder with the opposite hand.

Five Penalty runs awarded to the fielding side – by placing one hand on the opposite shoulder.

Leg bye – by touching a raised knee with the hand.

Revoke last signal – by touching both shoulders, each with the opposite hand.

Short run – by bending one arm upwards and touching the nearer shoulder with the tips of the fingers.

Free Hit – after signaling the No ball, the bowler's end umpire extends one arm straight upwards and moves it in a circular motion.

Powerplay Over – by rotating his/her arm in a large circle.

The following signal is for Level 4 player conduct offences. The signal has two parts, both of which should be acknowledged separately by the scorers.

Level 4 conduct

Part 1 – by putting one arm out to the side of the body and repeatedly raising it and lowering it.

Part 2 – by raising an index finger, held at shoulder height, to the side of the body.

2.13.1.4 All the signals in clause 2.13.1.3 are to be made by the bowler's end umpire except that for Short run, which is to be signalled by the umpire at the end where short running occurs. However, the bowler's end umpire shall be responsible both for the final signal of Short run to the scorers and, if more than one run is short, for informing them as to the number of runs to be recorded.

2.13.2 The umpire shall wait until each signal to the scorers has been separately acknowledged by a scorer before allowing play to proceed.

If several signals are to be used, they should be given in the order that the events occurred.

2.14 Informing the umpires

Wherever the umpires are to receive information from captains or other players under these Playing Conditions, it will be sufficient for one umpire to be so informed and for him/her to inform the other umpire.

2.15 Correctness of scores

Consultation between umpires and scorers on doubtful points is essential. The umpires shall, throughout the match, satisfy themselves as to the correctness of the number of runs scored, the wickets that have fallen and, where appropriate, the number of overs bowled.

The umpires shall ensure that they are able to contact the scorers at any time during the match and at its conclusion to address any issues relating to the correctness of scores.

3 THE SCORERS**3.1 Appointment of scorers**

Two scorers shall be appointed to record all runs scored, all wickets taken and, where appropriate, number of overs bowled.

3.2 Correctness of scores

The scorers shall frequently check to ensure that their records agree and consult with the umpires if necessary. See clause 2.15 (Correctness of scores).

3.3 Acknowledging signals

The scorers shall accept all instructions and signals given to them by the umpires and shall immediately acknowledge each separate signal.

4 THE BALL**4.1 Weight and size**

The ball, when new, shall weigh not less than 4.94 ounces/140 g, nor more than 5.31 ounces/151 g, and shall measure not less than 8.25 in/21.0 cm, nor more than 8.88 in/22.5 cm in circumference.

4.2 Approval and control of balls

- 4.2.1 The Home Board shall provide the best available high quality white cricket balls (e.g. Kookaburra 'Turf' or its equivalent) and spare used balls for changing during a match, which shall also be of the same brand. Note: The Home Board shall be required to advise the Visiting Board of the brand of ball to be used in the match(es) at least 30 days prior to the start of the match(es).
- 4.2.2 The fielding captain or her nominee may select the ball(s) with which she wishes to bowl from the supply provided by the Home Board. The reserve umpire shall take a box containing at least 6 new balls to the dressing room and supervise the selection of the ball(s).
- 4.2.3 The umpires shall retain possession of the match ball(s) throughout the duration of the match when play is not actually taking place.
- 4.2.4 During play umpires shall periodically and irregularly inspect the condition of the ball and shall retain possession of it at the fall of a wicket, or any other disruption in play.

4.3 New ball

- 4.3.1 One new ball shall be used at the start of each innings.

4.4 Ball lost or becoming unfit for play

If, during play, the ball cannot be found or recovered or the umpires agree that it has become unfit for play through normal use, the umpires shall replace it with a ball which has had wear comparable with that which the previous ball had received before the need for its replacement. When the ball is replaced, the umpire shall inform the batters and the fielding captain.

5 THE BAT**5.1 The bat**

- 5.1.1 The bat consists of two parts, a handle and a blade.
- 5.1.2 The basic requirements and measurements of the bat are set out in this clause with detailed specifications in paragraph 1 of Appendix B.

5.2 The handle

- 5.2.1 The handle is to be made principally of cane and/or wood.
- 5.2.2 The part of the handle that is wholly outside the blade is defined to be the upper portion of the handle. It is a straight shaft for holding the bat.
- 5.2.3 The upper portion of the handle may be covered with a grip as defined in paragraph 1.2.2 of Appendix B.

5.3 The blade

- 5.3.1 The blade comprises the whole of the bat apart from the handle as defined in clause 5.2 and in paragraph 1.3 of Appendix B.
- 5.3.2 The blade shall consist solely of wood.

5.4 Protection and repair

Subject to the specifications in paragraph 1.4 of Appendix B, and providing clause 5.5 is not contravened,

- 5.4.1 solely for the purposes of either protection from surface damage to the face, sides and shoulders of the blade or repair to the blade after surface damage, material that is not rigid, either at the time of its application to the blade or subsequently, may be placed on these surfaces.
- 5.4.2 for repair of the blade after damage other than surface damage
- 5.4.2.1 solid material may be inserted into the blade.
- 5.4.2.2 The only material permitted for any insertion is wood with minimal essential adhesives.
- 5.4.3 to prevent damage to the toe, material may be placed on that part of the blade but shall not extend over any part of the face, back or sides of the blade.

5.5 Damage to the ball

- 5.5.1 For any part of the bat, covered or uncovered, the hardness of the constituent materials and the surface texture thereof shall not be such that either or both could cause unacceptable damage to the ball.
- 5.5.2 Any material placed on any part of the bat, for whatever purpose, shall similarly not be such that it could cause unacceptable damage to the ball.
- 5.5.3 For the purpose of this clause, unacceptable damage is any change that is greater than normal wear and tear caused by the ball striking the uncovered wooden surface of the blade.

5.6 Contact with the ball

In these clauses,

- 5.6.1 reference to the bat shall imply that the bat is held in the batter's hand or a glove worn on her hand, unless stated otherwise.
- 5.6.2 contact between the ball and any of 5.6.2.1 to 5.6.2.4
- 5.6.2.1 the bat itself
- 5.6.2.2 the batter's hand holding the bat
- 5.6.2.3 any part of a glove worn on the batter's hand holding the bat

- 5.6.2.4 any additional materials permitted under 5.4 shall be regarded as the ball striking or touching the bat or being struck by the bat.

5.7 Bat size limits

- 5.7.1 The overall length of the bat, when the lower portion of the handle is inserted, shall not be more than 38 in/96.52 cm.
- 5.7.2 The blade of the bat shall not exceed the following dimensions:
Width: 4.25in/10.8 cm
Depth: 2.64in/6.7 cm
Edges: 1.56in/4.0cm.
- Furthermore, it should also be able to pass through a bat gauge as described in paragraph 1.6 of Appendix B.
- 5.7.3 The handle shall not exceed 52% of the overall length of the bat.
- 5.7.4 The material permitted for covering the blade in clause 5.4.1 shall not exceed 0.04 in/0.1 cm in thickness.
- 5.7.5 The maximum permitted thickness of protective material placed on the toe of the blade is 0.12 in/0.3 cm.

5.8 Categories of bat

- 5.8.1 Type A bats conform to clauses 5.1 to 5.7 inclusive.
- 5.8.2 Only Type A bats may be used in T20I matches.

6 THE PITCH

6.1 Area of pitch

The pitch is a rectangular area of the ground 22 yards/20.12 m in length and 10 ft/3.05 m in width. It is bounded at either end by the bowling creases and on either side by imaginary lines, one each side of the imaginary line joining the centres of the two middle stumps, each parallel to it and 5 ft/1.52 m from it. If the pitch is next to an artificial pitch which is closer than 5 ft/1.52 m from the middle stumps, the pitch on that side will extend only to the junction of the two surfaces. See clauses 8.1 (Description, width and pitching) and 7.2 (The bowling crease).

6.2 Fitness of pitch for play

The umpires shall be the sole judges of the fitness of the pitch for play. See clauses 2.7 (Fitness for play) and 2.8 (Suspension of play in dangerous or unreasonable conditions).

6.3 Selection and preparation

Before the match, the Ground Authority shall be responsible for the selection and preparation of the pitch. During the match, the umpires shall control its use and maintenance.

- 6.3.1 The Ground Authority shall ensure that during the period prior to the start of play and during intervals, the pitch area shall be roped off so as to prevent unauthorised access. (The pitch area shall include an area at least 2 metres beyond the rectangle made by the crease markings at both ends of the pitch).
- 6.3.2 The reserve umpire shall ensure that, prior to the start of play and during any intervals, only authorised staff, the match officials, players, team coaches and authorised television personnel shall be allowed access to the pitch area. Such access shall be subject to the following limitations:
- 6.3.2.1 Only captains and team coaches may walk on the actual playing surface of the pitch area (outside of the crease markings).
- 6.3.2.2 Access to the pitch area by television personnel shall be restricted to one camera crew (including one or two television commentators) of the official licensed television broadcaster(s) (but not news crews).
- 6.3.2.3 No spiked footwear shall be permitted.
- 6.3.2.4 No one shall be permitted to bounce a ball on the pitch, strike it with a bat or cause damage to the pitch in any other way.
- 6.3.2.5 Access shall not interfere with pitch preparation.
- 6.3.3 In the event of any dispute, the ICC Match Referee will rule and his/her ruling will be final.

6.4 Changing the pitch

- 6.4.1 If the on-field umpires decide that it is dangerous or unreasonable for play to continue on the match pitch, they shall stop play and immediately advise the ICC Match Referee.
- 6.4.2 The on-field umpires and the ICC Match Referee shall then consult with both captains.
- 6.4.3 If the captains agree to continue, play shall resume.
- 6.4.4 If the decision is not to resume play, the on-field umpires together with the ICC Match Referee shall consider whether the existing pitch can be repaired and the match resumed from the point it was stopped. In considering whether to authorise such repairs, the ICC Match Referee must consider whether this would place either side at an unfair advantage, given the play that had already taken place on the dangerous pitch.
- 6.4.5 If the decision is that the existing pitch cannot be repaired, then the match is to be abandoned with the following consequences:
- 6.4.5.1 In the event of the required number of overs to constitute a match having been completed at the time the match is abandoned, the result shall be determined according to the provisions of clause 16.4.2.
- 6.4.5.2 In the event of the required number of overs to constitute a match not having been completed, the match will be abandoned as a no result.

- 6.4.6 If the abandonment occurs on the day of the match, the ICC Match Referee shall consult with the Home Board with the objective of finding a way for a new match (including a new nomination of teams and toss) to commence on the same date and venue. Such a match may be played either on the repaired pitch or on another pitch, subject to the ICC Match Referee and the relevant Ground Authority both being satisfied that the new pitch will be of the required T20I standard. The playing time lost between the scheduled start time of the original match and the actual start time of the new match will be covered by the provisions of clause 12.
- 6.4.7 If it is not possible to start a new match on the scheduled day of the match, the relevant officials from the participating Boards shall agree on whether the match can be replayed within the existing tour schedule.
- 6.4.8 Throughout the above decision making processes, the ICC Match Referee shall keep informed both captains and the head of the Ground Authority. The head of the Ground Authority shall ensure that suitable and prompt public announcements are made.

6.5 Non-turf pitches

- 6.5.1 T20I matches shall be played on natural turf pitches.
- Note:** Home Boards may, prior to the commencement of the series, seek the approval of ICC to use a hybrid pitch as an alternate to a natural turf pitch.
- 6.5.2 The use of PVA and other adhesives in the preparation of pitches is not permitted

7 THE CREASES

7.1 The creases

The positions of a bowling crease, a popping crease and two return creases shall be marked by white lines, as set out in clauses 7.2, 7.3 and 7.4, at each end of the pitch. See paragraph 1 of Appendix C.

7.2 The bowling crease

The bowling crease, which is the back edge of the crease marking, is the line that marks the end of the pitch, as in clause 6.1 (Area of pitch). It shall be 8 ft 8 in/2.64 m in length.

7.3 The popping crease

The popping crease, which is the back edge of the crease marking, shall be in front of and parallel to the bowling crease and shall be 4 ft/1.22 m from it. The popping crease shall be marked to a minimum of 15 yards/13.71 m on either side of the imaginary line joining the centres of the two middle stumps and shall be considered to be unlimited in length.

7.4 The return creases

The return creases, which are the inside edges of the crease markings, shall be at right angles to the popping crease at a distance of 4 ft 4 in/1.32 m either side of the imaginary line joining the centres of the two middle stumps. Each return crease shall be marked from the popping crease to a minimum of 8 ft/2.44 m behind it and shall be considered to be unlimited in length.

7.5 Additional Crease Markings

As a guideline to the umpires for the calling of Wides on the offside, the crease markings detailed in paragraph 1 of Appendix C may be marked in white at each end of the pitch.

8 THE WICKETS

8.1 Description, width and pitching

Two sets of wickets shall be pitched opposite and parallel to each other in the centres of the bowling creases. Each set shall be 9 in/22.86 cm wide and shall consist of three wooden stumps with two wooden bails on top. See paragraph 2 of Appendix B.

8.2 Size of stumps

The tops of the stumps shall be 28 in/71.12 cm above the playing surface and shall be dome shaped except for the bail grooves. The portion of a stump above the playing surface shall be cylindrical apart from the domed top, with circular section of diameter not less than 1.38 in/3.50 cm nor more than 1.5 in/3.81 cm. See paragraph 2 of Appendix B.

For televised matches, the Home Board may provide a slightly larger cylindrical stump to accommodate the stump camera. When the larger stump is used, all three stumps must be exactly the same size.

8.3 The bails

- 8.3.1 The bails, when in position on top of the stumps,
- shall not project more than 0.5 in/1.27 cm above them.
 - shall fit between the stumps without forcing them out of the vertical.
- 8.3.2 Each bail shall conform to the following specifications. See paragraph 2 of Appendix B.
- Overall length 4.31 in/10.95 cm
 - Length of barrel 2.13 in /5.40 cm
 - Longer spigot 1.38 in/3.50 cm
 - Shorter spigot 0.81 in/2.06 cm.
- 8.3.3 The two spigots and the barrel shall have the same centre line.
- 8.3.4 Devices aimed at protecting player safety by limiting the distance that a bail can travel off the stumps will be allowed, subject to the approval of the Home Board and the ICC.

8.4 Dispensing with bails

The umpires may agree to dispense with the use of bails, if necessary. If they so agree then no bails shall be used at either end. The use of bails shall be resumed as soon as conditions permit. See clause 29.4 (Dispensing with bails).

8.5 LED Wickets

The use of approved LED Wickets is permitted. Refer also to paragraphs 3.8.1.6 and 4.2 of Appendix D.

9 PREPARATION AND MAINTENANCE OF THE PLAYING AREA**9.1 Rolling**

The pitch shall not be rolled during the match except as permitted in clauses 9.1.1 and 9.1.2.

9.1.1 Frequency and duration of rolling

During the match the pitch may be rolled at the request of the captain of the side batting second, for a period of not more than 7 minutes, before the start of the second innings.

9.1.2 Rolling after a delayed start

In addition to the rolling permitted above, if, after the toss and before the first innings of the match, the start is delayed, the captain of the batting side may request that the pitch be rolled for not more than 7 minutes. However, if the umpires together agree that the delay has had no significant effect on the state of the pitch, they shall refuse such request for rolling of the pitch.

9.1.3 Choice of rollers

If there is more than one roller available the captain of the batting side shall choose which one is to be used.

The following shall apply in addition to clause 9.1:

9.1.4 Prior to the scheduled time for the toss, the artificial drying of the pitch and outfield shall be at the discretion of the Ground Authority. Thereafter and throughout the match the drying of the outfield may be undertaken at any time by the Ground Authority, but the drying of the affected area of the pitch shall be carried out only on the instructions and under the supervision of the umpires. The umpires shall be empowered to have the pitch dried without reference to the captains at any time they are of the opinion that it is unfit for play.**9.1.5 The umpires may instruct the Ground Authority to use any available equipment, including any roller for the purpose of drying the pitch and making it fit for play.****9.1.6 An absorbent roller may be used to remove water from the covers including the cover on the match pitch.****9.2 Clearing debris from the pitch****9.2.1 The pitch shall be cleared of any debris**

9.2.1.1 between innings. This shall precede rolling if any is to take place.

9.2.1.2 at all intervals for meals.

9.2.2 The clearance of debris in clause 9.2.1 shall be done by sweeping, except where the umpires consider that this may be detrimental to the surface of the pitch. In this case the debris must be cleared from that area by hand, without sweeping.

9.2.3 In addition to 9.2.1, debris may be cleared from the pitch by hand, without sweeping, before mowing and whenever either umpire considers it necessary.

9.3 Mowing**9.3.1 Responsibility for mowing**

9.3.1.1 All mowings which are carried out before the match shall be the sole responsibility of the Ground Authority.

9.4 Watering the pitch

The pitch shall not be watered during the match.

9.5 Re-marking creases

Creases shall be re-marked whenever either umpire considers it necessary.

9.6 Maintenance of footholes

The umpires shall ensure that the holes made by the bowlers and batters are cleaned out and dried whenever necessary to facilitate play.

The umpires shall allow, if necessary, the returfing of footholes made by the bowlers in their delivery strides, or the use of quick-setting fillings for the same purpose.

In addition, the umpires shall see that wherever possible and whenever it is considered necessary, action is taken during all intervals in play to do whatever is practicable to improve the bowler's footholes.

9.7 Securing of footholds and maintenance of pitch

During play, umpires shall allow the players to secure their footholds by the use of sawdust provided that no damage to the pitch is caused and that clause 41 (Unfair play) is not contravened.

9.8 Protection and preparation of adjacent pitches during matches

The protection (by way of an appropriate cover) and preparation of pitches which are adjacent to the match pitch will be permitted during the match subject to the following:

9.8.1 Such measures will only be possible if requested by the Ground Authority and approved by the umpires before the start of the match.

9.8.2 Approval should only be granted where such measures are unavoidable and will not compromise the safety of the players or their ability to execute their actions with complete freedom.

- 9.8.3 The preparation work shall be carried out under the supervision of the reserve umpire.
- 9.8.4 The consent of the captains is not required but the umpires shall advise both captains and the ICC Match Referee before the start of the match on what has been agreed.

10 COVERING THE PITCH

10.1 Before the match

The use of covers before the match is the responsibility of the Ground Authority and may include full covering if required.

The pitch shall be entirely protected against rain up to the commencement of play.

However, the Ground Authority shall grant suitable facility to the captains to inspect the pitch before the nomination of their players and to the umpires to discharge their duties as laid down in clauses 2 (The umpires), 6 (The pitch), 7 (The creases), 8 (The wickets), and 9 (Preparation and maintenance of the playing area).

10.2 During the match

The pitch shall be entirely protected against rain up to the commencement of play, and for the duration of the period of the match.

The covers must totally protect the pitch and also the pitch surroundings, to a minimum of 5 metres either side of the pitch, and any worn or soft areas in the outfield.

The bowlers' run-ups shall be covered during inclement weather, in order to keep them dry, to a distance of at least 10 x 10 metres.

10.3 Removal of covers

All covers (including "hessian" or "scrim" covers used to protect the pitch against the sun) shall be removed not later than 2 ½ hours before the scheduled start of play provided it is not raining at the time, but the pitch will be covered again if rain falls prior to the commencement of play.

11 INTERVALS

11.1 An interval

- 11.1.1 The following shall be classed as intervals.
- Intervals between innings.
 - Any other agreed interval.
- 11.1.2 Only these intervals shall be considered as scheduled breaks for the purposes of clause 24.2.6.

11.2 Duration of interval

- 11.2.1 There shall be a 15 minute interval between innings, taken from the call of Time before the interval until the call of Play on resumption after the interval.

11.3 Allowance for interval between innings

Law 11.3 shall not apply.

11.4 Changing agreed times of intervals

- 11.4.1 If the innings of the team batting first is completed prior to the scheduled time for the interval, the interval shall take place immediately and the innings of the team batting second will commence correspondingly earlier. In circumstances where the side bowling first has not completed the allotted number of overs by the scheduled or re-scheduled cessation time for the first innings, the umpires shall reduce the length of the interval by the amount of time that the first innings over-ran. The minimum time for the interval will be 10 minutes.
- 11.4.2 However, following a lengthy delay or interruption prior to the completion of the innings of the team batting first, the Match Referee may, at his/her discretion, reduce the interval between innings from 15 minutes to no less than 10 minutes.
- 11.4.3 Such discretion should only be exercised after determining the adjusted overs per side based on a 15 minute interval. If having exercised this discretion, the rescheduled finishing time for the match is earlier than the latest possible finishing time, then these minutes should be deducted from the length of any interruption during the second innings before determining the overs remaining.

11.5 Intervals for drinks

- 11.5.1 No drinks intervals shall be permitted.
- 11.5.2 An individual player may be given a drink either on the boundary edge or at the fall of a wicket, on the field, provided that no playing time is wasted. No other drinks shall be taken onto the field without the permission of the umpires. Any player taking drinks onto the field shall be dressed in proper cricket attire (subject to the wearing of bibs – refer to the note in clause 24.1.4).

11.6 Scorers to be informed

The umpires shall ensure that the scorers are informed of all agreements about hours of play and intervals and of any changes made thereto as permitted under this clause.

12 START OF PLAY; CESSATION OF PLAY

12.1 Call of Play

The bowler's end umpire shall call Play before the first ball of the match and on the resumption of play after any interval or interruption.

12.2 Call of Time

The bowler's end umpire shall call Time, when the ball is dead, at the end of any session of play or as required by these Playing Conditions. See also clause 20.3 (Call of Over or Time).

12.3 Removal of bails

After the call of Time, the bails shall be removed from both wickets.

12.4 Starting a new over

Another over shall always be started at any time during the match, unless an interval is to be taken in the circumstances set out in clause 12.5.2, if the umpire, walking at normal pace, has arrived at the position behind the stumps at the bowler's end before the time agreed for the next interval has been reached.

12.5 Completion of an over

Other than at the end of the match,

12.5.1 if the agreed time for an interval is reached during an over, the over shall be completed before the interval is taken, except as provided for in clause 12.5.2.

12.5.2 when less than 3 minutes remains before the time agreed for the next interval, the interval shall be taken immediately if

either a batter is dismissed or retires or

the players have occasion to leave the field

whether this occurs during an over or at the end of an over.

Except at the end of an innings, if an over is thus interrupted it shall be completed on the resumption of play.

12.6 Conclusion of match

12.6.1 The match is concluded

12.6.1.1 as soon as a result as defined in clauses 16.1 to 16.5 (The result) is reached.

12.6.1.2 as soon as the prescribed number of overs have been completed.

12.6.2 The match is concluded if, without a conclusion having been reached under 12.6.1, the players leave the field for adverse conditions of ground, weather or light, or in exceptional circumstances, and no further play is possible.

12.7 Hours of Play; Minimum Overs Requirement

12.7.1 To be determined by the Home Board subject to there being 2 sessions of 1 hour 15 minutes each, separated by a 15 minute interval between innings.

Note: The playing hours of matches scheduled to take place at venues where dew is likely to be a factor should be determined so as to ensure that the effect of any dew is minimised.

12.8 Minimum Over Rates

12.8.1 The minimum over rate to be achieved in T20I Matches shall be 16 overs per hour.

12.8.2 The actual over rate shall be calculated at the end of each innings by the umpires.

12.8.3 In calculating the actual over rate for the match, allowances will be given as follows:

12.8.3.1 The time lost as a result of treatment given to a player by an authorised medical personnel on the field of play;

12.8.3.2 The time lost as a result of a player being required to leave the field as a result of a serious injury;

12.8.3.3 The time taken for all third umpire referrals and consultations and any umpire or player reviews;

12.8.3.4 The time lost as a result of time wasting by the batting side; and

12.8.3.5 The time lost due to all other circumstances that are beyond the control of the fielding side.

12.8.4 In the event of any time allowances being granted to the fielding team under clause 12.8.3.4 above (time wasting by batting team), then such time shall be deducted from the allowances granted to such batting team in the determination of its over rate.

12.8.5 In addition to the allowances as provided for above,

12.8.5.1 in the case of an innings that has been reduced due to any delay or interruption in play, an additional allowance of 1 minute for every full 3 overs by which the innings is reduced will be granted.

12.8.5.2 an additional allowance of 1 minute will be given for each of the 6th, 7th, 8th and 9th wickets taken during an innings.

12.8.6 If a batting team is bowled out within the time determined for that innings pursuant to these playing conditions (taking into account all of the time allowances set out above), the fielding side shall be deemed to have complied with the required minimum over rate.

12.8.7 The current over rate of the fielding team (+/- overs compared to the minimum rate required), shall be advised by the 3rd umpire every 30 minutes as a minimum.

13 INNINGS**13.1 Number of innings**

13.1.1 A match shall be one innings for each side.

13.2 Alternate innings

Each side shall take their innings alternately.

13.3 Completed innings

A side's innings is to be considered as completed if any of the following applies

13.3.1 the side is all out.

13.3.2 at the fall of a wicket or the retirement of a batter, further balls remain to be bowled but no further batter is available to come in.

13.3.3 the prescribed number of overs have been bowled to the batting side.

13.4 The toss

The captains shall toss a coin for the choice of innings, on the field of play and under the supervision of the ICC Match Referee, not earlier than 30 minutes, nor later than 15 minutes before the scheduled or any rescheduled time for the start of play. Note, however, the provisions of clause 1.3 (Captain).

13.5 Decision to be notified

As soon as the toss is completed, the captain of the side winning the toss shall decide whether to bat or to field and shall notify the opposing captain and the umpires of this decision. Once notified, the decision cannot be changed.

13.6 Duration of Match

13.6.1 All matches will consist of one innings per side, each innings being limited to a maximum of 20 overs. All matches shall be of one day's scheduled duration.

13.7 Length of Innings

13.7.1 Uninterrupted Matches.

13.7.1.1 Each team shall bat for 20 overs unless all out earlier.

13.7.1.2 If the team fielding first fails to bowl the required number of overs by the scheduled time for cessation of the first innings, play shall continue until the required number of overs has been bowled. The interval shall be reduced to enable the second innings to commence at the scheduled time, subject to there being a minimum interval of 10 minutes. The team batting second shall receive its full quota of 20 overs irrespective of the number of overs it bowled in the scheduled time for the cessation of the first innings.

13.7.1.3 If the team batting first is dismissed in less than 20 overs, the team batting second shall be entitled to bat for 20 overs.

13.7.1.4 If the team fielding second fails to bowl 20 overs by the scheduled cessation time, the hours of play shall be extended until the required number of overs has been bowled or a result is achieved.

13.7.1.5 Penalties shall apply for slow over rates (refer ICC Code of Conduct).

13.7.2 Delayed or Interrupted Matches

13.7.2.1 Delay or Interruption to the Innings of the Team Batting First (see paragraph 1 of Appendix E)

13.7.2.1.1 When playing time has been lost the revised number of overs to be bowled in the match shall be based on a rate of 16 overs per hour in the total remaining time available for play.

13.7.2.1.2 The revision of the number of overs should ensure, whenever possible, that both teams have the opportunity of batting for the same number of overs. The team batting second shall not bat for a greater number of overs than the first team unless the latter completed its innings in less than its allocated overs. To constitute a match, a minimum of 5 overs have to be bowled to the side batting second, subject to a result not being achieved earlier.

13.7.2.1.3 As soon as the total minutes of playing time remaining is less than the completed overs faced by Team 1 multiplied by 3.75, then the first innings is terminated and the provisions of 13.7.2.2 below take effect.

13.7.2.1.4 A fixed time will be specified for the commencement of the interval, and also the close of play for the match, by applying a rate of 16 overs per hour. When calculating the length of playing time available for the match, or the length of either innings, the timing and duration of all relative delays, extensions in playing hours, interruptions in play, and intervals, will be taken into consideration. This calculation must not cause the match to finish earlier than the original or rescheduled time for cessation of play on the final scheduled day for play. If required the original time shall be extended to allow for one extra over for each team.

13.7.2.1.5 If the team fielding first fails to bowl the revised number of overs by the specified time, play shall continue until the required number of overs have been bowled or the innings is completed.

13.7.2.1.6 Penalties shall apply for slow over rates (refer to the ICC Code of Conduct).

13.7.2.2 Delay or Interruption to the Innings of the Team Batting Second (see paragraph 2 of Appendix E)

13.7.2.2.1 When playing time has been lost and, as a result, it is not possible for the team batting second to have the opportunity of receiving its allocated, or revised allocation of overs in the playing time available, the number of overs shall be reduced at a rate of 16 overs per hour in respect of the lost playing time. Should the calculations result in a fraction of an over the fraction shall be ignored.

- 13.7.2.2.2 In addition, should the innings of the team batting first have been completed prior to the scheduled, or re-scheduled time for the commencement of the interval, then any calculation relating to the revision of overs shall not be effective until an amount of time equivalent to that by which the second innings started early has elapsed.
- 13.7.2.2.3 To constitute a match, a minimum of 5 overs have to be bowled to the team batting second subject to a result not being achieved earlier.
- 13.7.2.2.4 The team batting second shall not bat for a greater number of overs than the first team unless the latter completed its innings in less than its allocated overs.
- 13.7.2.2.5 A fixed time will be specified for the close of play by applying a rate of 16 overs per hour. The timing and duration of all relative delays, extensions in playing hours and interruptions in play, will be taken into consideration in specifying this time.
- 13.7.2.2.6 If the team fielding second fails to bowl the revised overs by the scheduled or re-scheduled close of play, the hours of play shall be extended until the overs have been bowled or a result achieved.
- 13.7.2.2.7 Penalties shall apply for slow over rates (refer to the ICC Code of Conduct).

13.8 Extra Time

The participating countries may agree to provide for extra time where the start of play is delayed or play is suspended. For clarity, the changeover period (maximum 10 mins) for a Super Over after the main match is not to be taken into account when applying any permitted extra time available.

13.9 Number of Overs per Bowler

- 13.9.1 No bowler shall bowl more than 4 overs in an innings.
- 13.9.2 In a delayed or interrupted match where the overs are reduced for both teams or for the team bowling second;
- 13.9.2.1 for innings of rescheduled length of at least 10 overs, no bowler may bowl more than one-fifth of the total overs allowed. Where the total overs is not divisible by 5, one additional over shall be allowed to the maximum number per bowler necessary to make up the balance.
- 13.9.2.2 for innings of rescheduled length of between 5 and 9 overs, no bowler may bowl more than two overs.

- 13.9.3 Where the total overs is not divisible by 5, one additional over shall be allowed to the maximum number per bowler necessary to make up the balance.
- 13.9.4 In the event of a bowler breaking down and being unable to complete an over, the remaining balls will be allowed by another bowler. Such part of an over will count as a full over only in so far as each bowler's limit is concerned.
- 13.9.5 The scoreboard shall show the total number of overs bowled and the number of overs bowled by each bowler.

14 THE FOLLOW-ON

Shall not apply.

15 DECLARATION AND FORFEITURE

Shall not apply.

16 THE RESULT

16.1 A Win – one-innings match

- 16.1.1 The side which has scored in its one innings a total of runs in excess of that scored by the opposing side in its one completed innings shall win the match. See clause 13.3 (Completed innings). Note also 16.4 (Winning hit or extras).
- 16.1.2 Save for circumstances where a match is awarded to a team as a consequence of the opposing team's refusal to play (clause 16.2), a result can be achieved only if both teams have had the opportunity of batting for at least 20 overs, unless one team has been all out in less than 5 overs or unless the team batting second scores enough runs to win in less than 5 overs.
- 16.1.3 Save for circumstances where a match is awarded to a team as a consequence of the opposing team's refusal to play (clause 16.2), all matches in which both teams have not had an opportunity of batting for a minimum of 5 overs, shall be declared a No Result.

16.2 ICC Match Referee awarding a match

- 16.2.1 A match shall be lost by a side which either
- 16.2.1.1 concedes defeat or
- 16.2.1.2 in the opinion of the ICC Match Referee refuses to play and the ICC Match Referee shall award the match to the other side.
- 16.2.2 If an umpire considers that an action by any player or players might constitute a refusal by either side to play then the umpires together shall inform the ICC Match Referee of this fact. The ICC Match Referee shall together with the umpires ascertain the cause of the action. If the ICC Match Referee, after due consultation with the umpires, then decides that this action does constitute a refusal to play by one side, he/she shall so inform the captain of that side. If the captain persists in the action the ICC Match Referee shall award the match in accordance with clause 16.2.1.2 above.

- 16.2.3 If action as in clause 16.2.2 above takes place after play has started and does not constitute a refusal to play the delay or interruption in play shall be dealt with in the same manner as provided for in clauses 13.7.2 (Delayed and Interrupted Matches) and 11.4 (Changing agreed times for intervals) above.

Note: In addition to the consequences of any refusal to play prescribed under this clause, any such refusal, whether temporary or final, may result in disciplinary action being taken against the captain and team responsible under the Code of Conduct.

16.3 All other matches – A Tie or No Result

16.3.1 A Tie

The result of a match shall be a Tie when all innings have been completed and the scores are equal.

If the scores are equal, the result shall be a tie and no account shall be taken of the number of wickets that have fallen. In the event of a tied match the teams shall compete in a Super Over to determine the winner. Refer to Appendix F.

16.3.2 No Result

See 16.13 above.

16.4 Prematurely Terminated Matches - Calculation of the Target Score

16.4.1 Interrupted Matches - Calculation of the Target Score

- 16.4.1.1 If, due to suspension of play after the start of the match, the number of overs in the innings of either team has to be revised to a lesser number than originally allotted (minimum of 5 overs), then a revised target score (to win) should be set for the number of overs which the team batting second will have the opportunity of facing. This revised target is to be calculated using the current Duckworth/Lewis/Stern method. The target set will always be a whole number and one run less will constitute a Tie. (Refer Duckworth/Lewis/Stern Regulations).

16.4.2 Prematurely Terminated Matches

- 16.4.2.1 If the innings of the side batting second is suspended (with at least 5 overs bowled) and it is not possible for the match to be resumed, the match will be decided by comparison with the DLS 'Par Score' determined at the instant of the suspension by the Duckworth/Lewis/Stern method (refer Duckworth/Lewis/Stern Regulations). If the score is equal to the par score, the match is a Tie. Otherwise the result is a victory, or defeat, by the margin of runs by which the score exceeds, or falls short of, the Par Score.

16.5 Winning hit or extras

- 16.5.1 As soon as a result is reached as defined in clauses 16.1, 16.2 or 16.3.1, the match is at an end. Nothing that happens thereafter, except as in clause 41.18.2 (Penalty runs), shall be regarded as part of it. Note also clause 16.8.

- 16.5.2 The side batting last will have scored enough runs to win only if its total of runs is sufficient without including any runs completed by the batters before the completion of a catch, or the obstruction of a catch, from which the striker could be dismissed.

- 16.5.3 If a boundary is scored before the batters have completed sufficient runs to win the match, the whole of the boundary allowance shall be credited to the side's total and, in the case of a hit by the bat, to the striker's score.

16.6 Statement of result

If the side batting last wins the match without losing all its wickets, the result shall be stated as a win by the number of wickets still then to fall.

If, without having scored a total of runs in excess of the total scored by the opposing side, the innings of the side batting last has been completed, but as the result of an award of 5 Penalty runs its total of runs is then sufficient to win, the result shall be stated as a win to that side by Penalty runs.

If the side fielding last wins the match, the result shall be stated as a win by runs.

If the match is decided by one side conceding defeat or refusing to play, the result shall be stated as Match Conceded or Match Awarded, as the case may be.

16.7 Correctness of result

Any decision as to the correctness of the scores shall be the responsibility of the umpires. See clause 2.15 (Correctness of scores).

16.8 Mistakes in scoring

If, after the players and umpires have left the field in the belief that the match has been concluded, the umpires discover that a mistake in scoring has occurred which affects the result then, subject to clause 16.9, they shall adopt the following procedure.

- 16.8.1 If, when the players leave the field, the side batting last has not completed its innings and

either the number of overs to be bowled in that innings has not been completed, or

the end of the innings has not been reached,

then, unless one side concedes defeat, the umpires shall order play to resume.

Unless a result is reached sooner, play will then continue, if conditions permit, until the prescribed number of overs has been completed. The number of overs shall be taken as they were at the call of Time for the supposed conclusion of the match. No account shall be taken of the time between that moment and the resumption of play.

- 16.8.2 If, at this call of Time, the overs have been completed and no Playing time remains, or if the side batting last has completed its innings, the umpires shall immediately inform both captains of the necessary corrections to the scores and to the result.

16.9 Result not to be changed

Once the umpires have agreed with the scorers the correctness of the scores at the conclusion of the match – see clauses 2.15 (Correctness of scores) and 3.2 (Correctness of scores) – the result cannot thereafter be changed.

16.10 Points

A points system shall not apply.

17 THE OVER**17.1 Number of balls**

The ball shall be bowled from each end alternately in overs of 6 balls.

17.2 Start of an over

An over has started when the bowler starts her run-up or, if there is no run-up, starts her action for the first delivery of that over.

17.3 Validity of balls

- 17.3.1 A ball shall not count as one of the 6 balls of the over unless it is delivered, even though, as in clause 41.16 (Non-striker leaving her ground early) a batter may be dismissed or some other incident occurs without the ball having been delivered.
- 17.3.2 A ball delivered by the bowler shall not count as one of the 6 balls of the over
- 17.3.2.1 if it is called dead, or is to be considered dead, before the striker has had an opportunity to play it. See clause 20.6 (Dead ball; ball counting as one of over).
 - 17.3.2.2 if it is called dead in the circumstances of clause 20.4.2.6. Note also the special provisions of clause 20.4.2.5 (Umpire calling and signaling Dead ball).
 - 17.3.2.3 if it is a No ball. See clause 21 (No ball).
 - 17.3.2.4 if it is a Wide. See clause 22 (Wide ball).
 - 17.3.2.5 when any of clauses 24.4 (Player returning without permission), 28.2 (Fielding the ball), 41.4 (Deliberate attempt to distract striker), or 41.5 (Deliberate distraction, deception or obstruction of batter) is applied.
- 17.3.3 Any deliveries other than those listed in clauses 17.3.1 and 17.3.2 shall be known as valid balls. Only valid balls shall count towards the 6 balls of the over.

17.4 Call of Over

When 6 valid balls have been bowled and when the ball becomes dead, the umpire shall call Over before leaving the wicket. See also clause 20.3 (Call of Over or Time).

17.5 Umpire miscounting

- 17.5.1 If the umpire miscounts the number of valid balls, the over as counted by the umpire shall stand.
- 17.5.2 If, having miscounted, the umpire allows an over to continue after 6 valid balls have been bowled, he/she may subsequently call Over when the ball becomes dead after any delivery, even if that delivery is not a valid ball.
- 17.5.3 Whenever possible, the third umpire shall liaise with the scorers and if possible inform the on-field umpires if the over has been miscounted.

17.6 Bowler changing ends

A bowler shall be allowed to change ends as often as desired, provided she does not bowl two overs consecutively, nor bowl parts of each of two consecutive overs, in the same innings.

17.7 Finishing an over

- 17.7.1 Other than at the end of an innings, a bowler shall finish an over in progress unless incapacitated or suspended under these Playing Conditions.
- 17.7.2 If for any reason, other than the end of an innings, an over is left uncompleted at the start of an interval or interruption, it shall be completed on resumption of play.

17.8 Bowler incapacitated or suspended during an over

If for any reason a bowler is incapacitated while running up to deliver the first ball of an over, or is incapacitated or suspended during an over, the umpire shall call and signal Dead ball. Another bowler shall complete the over from the same end, provided that she does not bowl two overs consecutively, nor bowl parts of each of two consecutive overs, in that innings.

18 SCORING RUNS**18.1 A run**

The score shall be reckoned by runs. A run is scored

- 18.1.1 so often as the batters, at any time while the ball is in play, have crossed and made good their ground from end to end.
- 18.1.2 when a boundary is scored. See clause 19 (Boundaries).
- 18.1.3 when Penalty runs are awarded. See clause 18.6.

18.2 Runs disallowed

Wherever in these Playing Conditions provision is made for the scoring of runs or awarding of penalties, such runs and penalties will be subject to any provisions that may be applicable for the disallowance of runs or for the non-award of penalties.

When runs are disallowed, the one run penalty for No ball or Wide shall stand and 5 run penalties shall be allowed, except for Penalty runs under clause 28.3 (Protective helmets belonging to the fielding side).

18.3 Short runs

- 18.3.1 A run is short if a batter fails to make good her ground in turning for a further run.
- 18.3.2 Although a short run shortens the succeeding one, the latter if completed shall not be regarded as short. A striker setting off for the first run from in front of the popping crease may do so also without penalty.

18.4 Unintentional short runs

Except in the circumstances of clause 18.5,

- 18.4.1 if either batter runs a short run, the umpire concerned shall, unless a boundary is scored, call and signal Short run as soon as the ball becomes dead and that run shall not be scored.
- 18.4.2 if, after either or both batters run short, a boundary is scored the umpire concerned shall disregard the short running and shall not call or signal Short run.
- 18.4.3 if both batters run short in one and the same run, this shall be regarded as only one short run.
- 18.4.4 if more than one run is short then, subject to clauses 18.4.2 and 18.4.3, all runs called as short shall not be scored.
- 18.4.5 if there has been more than one short run, the umpire shall inform the scorers as to the number of runs to be recorded.

18.5 Deliberate short runs

- 18.5.1 If either umpire considers that one or both batters deliberately ran short at that umpire's end, the umpire concerned shall, when the ball is dead, call and signal Short run and inform the other umpire of what has occurred and apply clause 18.5.2.
- 18.5.2 The bowler's end umpire shall
- disallow all runs to the batting side
 - return any not out batter to her original end
 - signal No ball or Wide to the scorers, if applicable
 - award 5 Penalty runs to the fielding side
 - award any other 5-run Penalty that is applicable except for Penalty runs under clause 28.3 (Protective helmets belonging to the fielding side)
 - inform the scorers as to the number of runs to be recorded, and
 - inform the captain of the fielding side and, as soon as practicable, the captain of the batting side of the reason for this action.

18.6 Runs awarded for penalties

Runs shall be awarded for penalties under clauses 18.5 (Deliberate short runs), 21 (No ball), 22 (Wide ball), 24.4 (Player returning without permission), 26.4 (Penalties for contravention), 28.2 (Fielding the ball), 28.3 (Protective helmets belonging to the fielding side) 41 (Unfair play) and 42 (Players' conduct). Note, however, the restrictions on the award of Penalty runs in clauses 23.3 (Leg byes not to be awarded), 28.3 (Protective helmets belonging to the fielding side) and 34 (Hit the ball twice).

18.7 Runs scored for boundaries

Runs shall be scored for boundary allowances under clause 19 (Boundaries).

18.8 Runs scored when a batter is dismissed

When a batter is dismissed, any runs for penalties awarded to either side shall stand.

No other runs shall be credited to the batting side, except as follows.

- 18.8.1 If a batter is dismissed Obstructing the field, the batting side shall also score any runs completed before the offence.
- If, however, the obstruction prevented a catch being made, no runs other than penalties shall be scored.
- 18.8.2 If a batter is dismissed Run out, the batting side shall also score any runs completed before the wicket was put down.

18.9 Runs scored when the ball becomes dead other than at the fall of a wicket

When the ball becomes dead for any reason other than the fall of a wicket, or is called dead by an umpire, unless there is specific provision otherwise in these Playing Conditions, any runs for penalties awarded to either side shall be scored. Note however the provisions of clauses 23.3 (Leg byes not to be awarded) and 28.3 (Protective helmets belonging to the fielding side).

Additionally the batting side shall be credited with all runs completed by the batters before the incident or call of Dead ball and the run in progress if the batters had already crossed at the instant of the incident or call of Dead ball. Note specifically, however, the provisions of clause 41.5.8 (Deliberate distraction, deception or obstruction of batter).

18.10 Crediting of runs scored

Unless stated otherwise in these Playing Conditions,

- 18.10.1 if the ball is struck by the bat, all runs scored by the batting side shall be credited to the striker, except for the following:
- an award of 5 Penalty runs, which shall be scored as Penalty runs
 - the one run penalty for a No ball, which shall be scored as a No ball extra.
- 18.10.2 if the ball is not struck by the bat, runs shall be scored as Penalty runs, Byes, Leg byes, No ball extras or Wides as the case may be. If Byes or Leg byes accrue from a No ball, only the one run penalty for No ball shall be scored as such, and the remainder as Byes or Leg byes as appropriate.

18.10.3 the bowler shall be debited with:

- all runs scored by the striker
- all runs scored as No ball extras
- all runs scored as Wides.

18.11 Batter returning to original end

18.11.1 When the striker is dismissed in any of the circumstances in clauses 18.11.1.1 to 18.11.1.5, the not out batter shall return to her original end.

- 18.11.1.1 Bowled.
- 18.11.1.2 Stumped.
- 18.11.1.3 Hit the ball twice.
- 18.11.1.4 LBW.
- 18.11.1.5 Hit wicket.

18.11.2 The batters shall return to their original ends in any of the cases of clauses 18.11.2.1 to 18.11.2.3.

- 18.11.2.1 A boundary is scored.
- 18.11.2.2 Runs are disallowed for any reason.
- 18.11.2.3 A decision by the batters at the wicket to do so, under clause 41.5 (Deliberate distraction, deception or obstruction of batter).

18.12 Batter returning to wicket she has left

18.12.1 When a batter is dismissed in any of the ways in clauses 18.12.1.1 to 18.12.1.3, the not out batter shall return to the wicket she has left but only if the batters had not already crossed at the instant of the incident causing the dismissal. If runs are to be disallowed, however, the not out batter shall return to her original end.

- 18.12.1.1 Caught
- 18.12.1.2 Obstructing the field
- 18.12.1.3 Run out.

18.12.2 If, while a run is in progress, the ball becomes dead for any reason other than the dismissal of a batter, the batters shall return to the wickets they had left, but only if they had not already crossed in running when the ball became dead. If, however, any of the circumstances of clauses 18.11.2.1 to 18.11.2.3 apply, the batters shall return to their original ends.

19 BOUNDARIES

19.1 Determining the boundary of the field of play

- 19.1.1 Before the toss, the umpires shall determine the boundary of the field of play, which shall be fixed for the duration of the match. See clause 2.3.4 (Consultation with Home Board).
- 19.1.2 The boundary shall be determined such that no part of any sight-screen, will, at any stage of the match, be within the field of play.
- 19.1.3 With respect to the size of the boundaries, no boundary shall be longer than 65 yards (59.43 metres), and no boundary should be shorter than 55 yards (50.29 metres) from the centre of the pitch to be used.
- 19.1.4 Any ground on which a Test or ODI International has been played prior to 1 October 2005 which cannot conform to these minimum dimensions shall be exempt from this playing condition. Any new ground must conform to these minimum dimensions.

19.2 Identifying and marking the boundary

- 19.2.1 All boundaries must be designated by a rope, or similar object of a minimum standard as authorised by the ICC from time to time. The rope should be positioned a required minimum distance (3 yards (2.74 metres) minimum) inside the perimeter fencing or advertising signs, or from any solid object located between the rope and the fence/signs. For grounds with a large playing area, the maximum length of boundary should be used before applying the minimum 3 yards (2.74 metres) between the boundary and the fence.
- 19.2.2 If the boundary is marked by means of an object that is in contact with the ground the boundary will be the edge of the grounded part of the object which is nearest the pitch.
- 19.2.3 An obstacle within the field of play shall not be regarded as a boundary unless so determined by the umpires before the toss. See clause 2.3.4 (Consultation with Home Board).
- 19.2.4 If an unauthorized person enters the playing arena and handles the ball, the umpire at the bowler's end shall be the sole judge of whether the boundary allowance should be scored or the ball be treated as still in play or called dead ball if a batter is liable to be out as a result of the unauthorized person handling the ball.

19.3 Restoring the boundary

If a solid object used to mark the boundary is disturbed for any reason, then:

- 19.3.1 the boundary shall be considered to be in its original position.
- 19.3.2 the object shall be returned to its original position as soon as is practicable; if play is taking place, this shall be as soon as the ball is dead.
- 19.3.3 if some part of a fence or other marker has come within the field of play, that part shall be removed from the field of play as soon as is practicable; if play is taking place, this shall be as soon as the ball is dead.

19.4 Ball grounded beyond the boundary

- 19.4.1 The ball in play is grounded beyond the boundary if it touches
- the boundary or any part of an object used to mark the boundary;
 - the ground beyond the boundary;
 - any object that is grounded beyond the boundary.
- 19.4.2 The ball in play is to be regarded as being grounded beyond the boundary if
- a fielder, grounded beyond the boundary as in clause 19.5, touches the ball;
 - a fielder, after catching the ball within the boundary, becomes grounded beyond the boundary while in contact with the ball, before completing the catch.

19.5 Fielder grounded beyond the boundary

- 19.5.1 A fielder is grounded beyond the boundary if some part of her person is in contact with any of the following:
- the boundary or any part of an object used to mark the boundary;
 - the ground beyond the boundary;
 - any object that is in contact with the ground beyond the boundary;
 - another fielder who is grounded beyond the boundary.
- 19.5.2 A fielder who is not in contact with the ground is considered to be grounded beyond the boundary if her final contact with the ground, before her first contact with the ball after it has been delivered by the bowler, was not entirely within the boundary.

19.6 Boundary allowances

- 19.6.1 6 runs shall be allowed for a boundary 6; and 4 runs for a boundary 4. See also clause 19.7.

19.7 Runs scored from boundaries

- 19.7.1 A boundary 6 will be scored if and only if the ball has been struck by the bat and is first grounded beyond the boundary without having been in contact with the ground within the field of play. This shall apply even if the ball has previously touched a fielder.
- 19.7.2 A boundary 4 will be scored when a ball that is grounded beyond the boundary
- whether struck by the bat or not, was first grounded within the boundary, or
 - has not been struck by the bat.

- 19.7.3 When a boundary is scored, the batting side, except in the circumstances of clause 19.8, shall be awarded whichever is the greater of

19.7.3.1 the allowance for the boundary

19.7.3.2 the runs completed by the batters together with the run in progress if they had already crossed at the instant the boundary is scored.

- 19.7.4 When the runs in clause 19.7.3.2 exceed the boundary allowance they shall replace the boundary allowance for the purposes of clause 18.12.2.

- 19.7.5 The scoring of Penalty runs by either side is not affected by the scoring of a boundary.

19.8 Overthrow or wilful act of fielder

If the boundary results from an overthrow or from the wilful act of a fielder, the runs scored shall be

any runs for penalties awarded to either side

and the allowance for the boundary

and the runs completed by the batters, together with the run in progress if they had already crossed at the instant of the throw or act.

Clause 18.12.2 (Batter returning to wicket she has left) shall apply as from the instant of the throw or act.

20 DEAD BALL**20.1 Ball is dead**

- 20.1.1 The ball becomes dead when
- 20.1.1.1 it is finally settled in the hands of the wicket-keeper or of the bowler.
- 20.1.1.2 a boundary is scored. See clause 19.7 (Runs scored from boundaries).
- 20.1.1.3 a batter is dismissed. The ball will be deemed to be dead from the instant of the incident causing the dismissal.
- 20.1.1.4 whether played or not it becomes trapped between the bat and person of a batter or between items of her clothing or equipment.
- 20.1.1.5 whether played or not it lodges in the clothing or equipment of a batter or the clothing of an umpire.
- 20.1.1.6 there is an award of Penalty runs under either of clauses 24.4 (Player returning without permission) or 28.3 (Fielding the ball). The ball shall not count as one of the over.
- 20.1.1.7 there is a contravention of clause 28.3 (Protective helmets belonging to the fielding side).
- 20.1.1.8 the match is concluded in any of the ways stated in clause 12.6 (Conclusion of match).

- 20.12 The ball shall be considered to be dead when it is clear to the bowler's end umpire that the fielding side and both batters at the wicket have ceased to regard it as in play.
- 20.13 In a match where cameras are being used on or over the field of play (e.g. Spydercam), should a ball that has been hit by the batter make contact, while still in play, with the camera, its apparatus or its cable, either umpire shall call and signal 'dead ball'. The ball shall not count as one of the over and no runs shall be scored. If the delivery was called a No ball it shall count and the No ball penalty shall be applied. No other runs (including penalty runs) apart from the No ball penalty shall be scored.
- 20.14 Should a ball thrown by a fielder make contact with a camera on or over the field of play, its apparatus or its cable, either umpire shall call and signal dead ball. Unless this was already a No ball or Wide, the ball shall count as one of the over. All runs scored to that point shall count, plus the run in progress if the batters have already crossed.
- 20.15 Refer also to paragraph 2.6 of Appendix D.

20.2 Ball finally settled

Whether the ball is finally settled or not is a matter for the umpire alone to decide.

20.3 Call of Over or Time

Neither the call of Over (see clause 17.4), nor the call of Time (see clause 12.2) is to be made until the ball is dead, either under clauses 20.1 or 20.4.

20.4 Umpire calling and signalling Dead ball

- 20.4.1 When the ball has become dead under clause 20.1, the bowler's end umpire may call and signal Dead ball if it is necessary to inform the players.
- 20.4.2 Either umpire shall call and signal Dead ball when
- 20.4.2.1 intervening in a case of unfair play.
 - 20.4.2.2 a possibly serious injury to a player or umpire occurs.
 - 20.4.2.3 leaving his/her normal position for consultation.
 - 20.4.2.4 one or both bails fall from the striker's wicket before the striker has had the opportunity of playing the ball.
 - 20.4.2.5 the striker is not ready for the delivery of the ball and, if the ball is delivered, makes no attempt to play it. Provided the umpire is satisfied that the striker had adequate reason for not being ready, the ball shall not count as one of the over.
 - 20.4.2.6 the striker is distracted by any noise or movement or in any other way while preparing to receive, or receiving a delivery. This shall apply whether the source of the distraction is within the match or outside it. Note also clause 20.4.2.7. The ball shall not count as one of the over.

- 20.4.2.7 there is an instance of a deliberate attempt to distract under either of clauses 41.4 (Deliberate attempt to distract striker) or 41.5 (Deliberate distraction, deception or obstruction of batter). The ball shall not count as one of the over.
- 20.4.2.8 the bowler drops the ball accidentally before delivery.
- 20.4.2.9 the ball does not leave the bowler's hand for any reason other than an attempt to run out the non-striker under clause 41.16 (Non-striker leaving her ground early).
- 20.4.2.10 satisfied that the ball in play cannot be recovered.
- 20.4.2.11 required to do so under any of the Playing Conditions not included above.

20.5 Ball ceases to be dead

The ball ceases to be dead – that is, it comes into play – when the bowler starts her run-up or, if there is no run-up, starts her bowling action.

20.6 Dead ball; ball counting as one of over

- 20.6.1 When a ball which has been delivered is called dead or is to be considered dead then, other than as in clause 20.6.2,
- 20.6.1.1 it will not count in the over if the striker has not had an opportunity to play it.
 - 20.6.1.2 Unless No ball or Wide ball has been called, it will be a valid ball if the striker has had an opportunity to play it, except in the circumstances of clauses 20.4.2.6 and 24.4 (Player returning without permission), 28.2 (Fielding the ball), 41.4 (Deliberate attempt to distract striker) and 41.5 (Deliberate distraction, deception or obstruction of batter).
- 20.6.2 In clause 20.4.2.5, the ball will not count in the over only if both conditions of not attempting to play the ball and having an adequate reason for not being ready are met. Otherwise the delivery will be a valid ball.

21 NO BALL

21.1 Mode of delivery

- 21.1.1 The umpire shall ascertain whether the bowler intends to bowl right handed or left handed, over or round the wicket, and shall so inform the striker.
- It is unfair if the bowler fails to notify the umpire of a change in her mode of delivery. In this case the umpire shall call and signal No ball.
- 21.1.2 Underarm bowling shall not be permitted.

21.2 Fair delivery – the arm

For a delivery to be fair in respect of the arm the ball must not be delivered with an Illegal Bowling Action.

An Illegal Bowling Action is defined as a bowling action where a bowler's Elbow Extension exceeds 15 degrees, measured from the point at which the bowling arm reaches the horizontal until the point at which the ball is released (any Elbow Hyperextension shall be discounted for the purposes of determining an Illegal Bowling Action).

Should either umpire or the ICC Match Referee suspect that a bowler has used an Illegal Bowling Action, they shall complete the ICC Bowling Action Report Form at the conclusion of the match, as set out in the Illegal Bowling Regulations.

21.3 Ball thrown or delivered underarm – action by umpires

21.3.1 If, in the opinion of either umpire, the ball has been thrown (where such mode of delivery does not correspond to the bowler's normal bowling action) or delivered underarm, he/she shall call and signal No ball and, when the ball is dead, inform the other umpire of the reason for the call.

The bowler's end umpire shall then

- warn the bowler, indicating that this is a first and final warning. This warning shall apply to that bowler throughout the innings.
- inform the captain of the fielding side of the reason for this action.
- inform the batters at the wicket of what has occurred.

21.3.2 If either umpire considers that, in that innings, a further delivery by the same bowler is thrown (where such mode of delivery does not correspond to the bowler's normal bowling action) or delivered underarm, he/she shall call and signal No ball and when the ball is dead inform the other umpire of the reason for the call.

The bowler's end umpire shall then

- direct the captain of the fielding side to suspend the bowler immediately from bowling. The over shall, if applicable, be completed by another bowler, who shall neither have bowled the previous over or part thereof nor be allowed to bowl any part of the next over. The bowler thus suspended shall not bowl again in that innings.
- inform the batters at the wicket and, as soon as practicable, the captain of the batting side of the reason for this action.

21.3.3 The umpires together shall report the occurrence as soon as possible after the match to the ICC Match Referee, who shall take such action as is considered appropriate against the bowler concerned.

21.4 Bowler throwing towards striker's end before delivery

If the bowler throws the ball towards the striker's end before entering the delivery stride, either umpire shall call and signal No ball. See clause 41.17 (Batters stealing a run).

However, the procedure stated in clause 21.3 of caution, informing, final warning, action against the bowler and reporting shall not apply.

21.5 Fair delivery – the feet

For a delivery to be fair in respect of the feet, in the delivery stride

- 21.5.1 the bowler's back foot must land within and not touching the return crease appertaining to her stated mode of delivery.
- 21.5.2 the bowler's front foot must land with some part of the foot, whether grounded or raised
 - on the same side of the imaginary line joining the two middle stumps as the return crease described in clause 21.5.1, and
 - behind the popping crease.

If the bowler's end umpire is satisfied that any of these three conditions have not been met, he/she shall call and signal No ball. See clause 41.8 (Bowling of deliberate front foot No ball).

21.6 Bowler breaking wicket in delivering ball

Either umpire shall call and signal No ball if, other than in an attempt to run out the non-striker under clause 41.16, the bowler breaks the wicket at any time after the ball comes into play and before completion of the stride after the delivery stride. This shall include any clothing or other object that falls from her person and breaks the wicket.

21.7 Ball bouncing more than once, rolling along the ground or pitching off the pitch

The umpire shall call and signal No ball if a ball which he/she considers to have been delivered, without having previously touched bat or person of the striker,

- bounces more than once
- or rolls along the ground before it reaches the popping crease.
- or pitches wholly or partially off the pitch as defined in clause 6.1 (Area of pitch) before it reaches the line of the striker's wicket.

21.8 Ball coming to rest in front of striker's wicket

If a ball delivered by the bowler comes to rest in front of the line of the striker's wicket, without having previously touched the bat or person of the striker, the umpire shall call and signal No ball and immediately call and signal Dead ball.

21.9 Fielder intercepting a delivery

If except in the circumstances of clause 27.3 (Position of wicket-keeper) a ball, delivered by the bowler, makes contact with any part of a fielder's person before it either makes contact with the striker's bat or person, or it passes the striker's wicket, the umpire shall call and signal No ball and immediately call and signal Dead ball.

21.10 Ball bouncing over head height of striker

See clauses 22.1.1.2 and 41.6.1.7.

21.11 Call of No ball for infringement of other Playing Conditions

In addition to the instances above, No ball is to be called and signalled as required by the following clauses:

Clause 27.3 – Position of wicket-keeper

Clause 28.4 – Limitation of on side fielders

Clause 28.5 – Fielders not to encroach on pitch

Clause 41.6 – Bowling of dangerous and unfair short pitched deliveries

Clause 41.7 – Bowling of dangerous and unfair non-pitching deliveries

Clause 41.8 – Bowling of deliberate front foot No ball.

21.12 Revoking a call of No ball

An umpire shall revoke the call of No ball if Dead ball is called under any of clauses 20.4.2.4 to 20.4.2.9 (Umpire calling and signaling Dead ball). However, if a no ball is called in breach of clause 20.4.2.7 (41.4 - Deliberate attempt to distract striker before playing the ball or 41.5 – Deliberate attempt of Distraction, Deception or Obstruction of striker after the stroke) the No ball will stand.

21.13 No ball to over-ride Wide

A call of No ball shall over-ride the call of Wide ball at any time. See clauses 22.1 (Judging a Wide) and 22.2 (Call and signal of Wide ball).

21.14 Ball not dead

The ball does not become dead on the call of No ball.

21.15 Penalty for a No ball

A penalty of one run shall be awarded instantly on the call of No ball. Unless the call is revoked, the penalty shall stand even if a batter is dismissed. It shall be in addition to any other runs scored, any boundary allowance and any other runs awarded for penalties.

21.16 Runs resulting from a No ball – how scored

The one run penalty shall be scored as a No ball extra and shall be debited against the bowler. If other Penalty runs have been awarded to either side these shall be scored as stated in clause 41.18 (Penalty runs). Any runs completed by the batters or any boundary allowance shall be credited to the striker if the ball has been struck by the bat; otherwise they shall also be scored as Byes or Leg byes as appropriate.

21.17 No ball not to count

A No ball shall not count as one of the over. See clause 17.3 (Validity of balls).

21.18 Out from a No ball

When No ball has been called, neither batter shall be out under any of the Playing Conditions except clause 34 (Hit the ball twice), clause 37 (Obstructing the field) or clause 38 (Run out).

21.19 Free Hit

- 21.19.1 In addition to the above, the delivery following a No ball called (all modes of No ball) shall be a free hit for whichever batter is facing it. If the delivery for the free hit is not a legitimate delivery (any kind of No ball or a Wide ball) then the next delivery will become a free hit for whichever batter is facing it.
- 21.19.2 For any free hit, the striker can be dismissed only under the circumstances that apply for a No ball, even if the delivery for the free hit is called Wide ball.
- 21.19.3 Neither field changes nor the exchange of individuals between fielding positions are permitted for free hit deliveries unless:
- 21.19.3.1 There is a change of striker (the provisions of clause 41.2 shall apply), or
- 21.19.3.2 The No Ball was the result of a fielding restriction breach, in which case the field may be changed to the extent of correcting the breach.
- 21.19.4 For clarity, the bowler can change her mode of delivery for the free hit delivery. In such circumstances clause 21.1 shall apply.
- 21.19.5 The umpires will signal a free hit by (after the normal No Ball signal) extending one arm straight upwards and moving it in a circular motion.

22 WIDE BALL**22.1 Judging a Wide**

- 22.1.1 If the bowler bowls a ball, not being a No ball, the umpire shall adjudge it a Wide if, according to the definition in clause 22.1.2
- 22.1.1.1 the ball passes wide of where the striker is standing and which also would have passed wide of the striker standing in a normal guard position.
- 22.1.1.2 the ball passes above the head height of the striker standing upright at the popping crease.
- 22.1.2 The ball will be considered as passing wide of the striker unless it is sufficiently within reach for her to be able to hit it with the bat by means of a normal cricket stroke.
- 22.1.3 Umpires are instructed to apply very strict and consistent interpretation in regard to this clause in order to prevent negative bowling wide of the wicket.

22.2 Call and signal of Wide ball

If the umpire adjudges a delivery to be a Wide he/she shall call and signal Wide ball as soon as the ball passes the striker's wicket. It shall, however, be considered to have been a Wide from the instant that the bowler entered her delivery stride, even though it cannot be called Wide until it passes the striker's wicket.

22.3 Revoking a call of Wide ball

- 22.3.1 The umpire shall revoke the call of Wide ball if there is then any contact between the ball and the striker's bat or person before the ball comes into contact with any fielder.
- 22.3.2 The umpire shall revoke the call of Wide ball if a delivery is called a No ball. See clause 21.13 (No ball to over-ride Wide).

22.4 Delivery not a Wide

- 22.4.1 The umpire shall not adjudge a delivery as being a Wide, if the striker, by moving, either causes the ball to pass wide of her, as defined in clause 22.1.2 or brings the ball sufficiently within reach to be able to hit it by means of a normal cricket stroke.
- 22.4.2 The umpire shall not adjudge a delivery as being a Wide if the ball touches the striker's bat or person, but only as the ball passes the striker.

22.5 Ball not dead

The ball does not become dead on the call of Wide ball.

22.6 Penalty for a Wide

A penalty of one run shall be awarded instantly on the call of Wide ball. Unless the call is revoked, see clause 22.3, this penalty shall stand even if a batter is dismissed, and shall be in addition to any other runs scored, any boundary allowance and any other runs awarded for penalties.

22.7 Runs resulting from a Wide – how scored

All runs completed by the batters or a boundary allowance, together with the penalty for the Wide, shall be scored as Wide balls. Apart from any award of 5 Penalty runs, all runs resulting from a Wide shall be debited against the bowler.

22.8 Wide not to count

A Wide shall not count as one of the over. See clause 17.3 (Validity of balls).

22.9 Out from a Wide

When Wide ball has been called, neither batter shall be out under any of the Playing Conditions except clause 35 (Hit wicket), clause 37 (Obstructing the field), clause 38 (Run out) or clause 39 (Stumped).

23 BYE AND LEG BYE**23.1 Byes**

If the ball, delivered by the bowler, not being a Wide, passes the striker without touching her bat or person, any runs completed by the batters from that delivery, or a boundary allowance, shall be credited as Byes to the batting side. Additionally, if the delivery is a No ball, the one run penalty for such a delivery shall be incurred.

23.2 Leg byes

- 23.2.1 If a ball delivered by the bowler first strikes the person of the striker, runs shall be scored only if the umpire is satisfied that the striker has either attempted to play the ball with the bat or tried to avoid being hit by the ball.
- 23.2.2 If the umpire is satisfied that either of these conditions has been met runs shall be scored as follows.
- 23.2.2.1 If there is either no subsequent contact with the striker's bat or person, or only inadvertent contact with the striker's bat or person any runs completed by the batters or a boundary allowance shall be credited to the striker in the case of subsequent contact with her bat but otherwise to the batting side as in clause 23.2.3.
- 23.2.2.2 If the striker wilfully makes a lawful second strike, clause 34.3 (Ball lawfully struck more than once) and clause 34.4 (Runs permitted from ball lawfully struck more than once) shall apply.
- 23.2.3 The runs in clause 23.2.2.1, unless credited to the striker, shall be scored as Leg byes.
- Additionally, if the delivery is a No ball, the one run penalty for the No ball shall be incurred.

23.3 Leg byes not to be awarded

If in the circumstance of clause 23.2.1 the umpire considers that neither of the conditions therein has been met, then Leg byes shall not be awarded.

If the ball does not become dead for any other reason, the umpire shall call and signal Dead ball as soon as the ball reaches the boundary or at the completion of the first run.

The umpire shall then:

- disallow all runs to the batting side;
- return any not out batter to her original end;
- signal No ball to the scorers if applicable;
- award any 5-run Penalty that is applicable except for Penalty runs under clause 28.3 (Protective helmets belonging to the fielding side).

24 FIELDER'S ABSENCE; SUBSTITUTES**24.1 Substitute fielders**

- 24.1.1 The umpires shall allow a substitute fielder
- 24.1.1.1 if they are satisfied that a fielder has been injured or become ill and that this occurred during the match, or
- 24.1.1.2 for any other wholly acceptable reason.
- In all other circumstances, a substitute is not allowed.
- 24.1.2 A substitute shall not bowl or act as captain but may act as wicket-keeper only with the consent of the umpires. Note, however, clause 42.4.1.
- 24.1.3 A nominated player may bowl or field even though a substitute has previously acted for her, subject to 24.2 and 24.3.
- 24.1.4 Squad members of the fielding or batting team who are not playing in the match and who are not acting as substitute fielders shall be required to wear a team training bib whilst on the playing area (including the area between the boundary and the perimeter fencing).

24.2 Fielder absent or leaving the field of play

- 24.2.1 A player going briefly outside the boundary while carrying out any duties as a fielder is not absent from the field of play nor, for the purposes of this clause, is she to be regarded as having left the field of play.
- 24.2.2 If a fielder fails to take the field at the start of play or at any later time, or leaves the field during play,
- 24.2.2.1 an umpire shall be informed of the reason for this absence.
- 24.2.2.2 she shall not thereafter come on to the field of play during a session of play without the consent of the umpire. See clause 24.4. The umpire shall give such consent as soon as it is practicable.
- 24.2.3 If a player is absent from the field for longer than 8 minutes, the following restrictions shall apply to their future participation in the match:
- 24.2.3.1 The player shall not be permitted to bowl in the match until she has either been able to field, or her team has subsequently been batting, for the total length of playing time for which the player was absent (hereafter referred to as Penalty time). A player's unexpired Penalty time shall be limited to a maximum of 35 minutes. If any unexpired Penalty time remains at the end of an innings, it is carried forward to the next and subsequent innings of the match.

- 24.2.3.2 The player shall not be permitted to bat in the match until her team's batting innings has been in progress for the length of playing time that is equal to the unexpired Penalty time carried forward from the previous innings. However, once her side has lost five wickets in its batting innings, she may bat immediately. If any unexpired penalty time remains at the end of that batting innings, it is carried forward to the next and subsequent innings of the match.
- 24.2.4 If the player leaves the field before having served all of her Penalty time, the balance is carried forward as unserved Penalty time.
- 24.2.5 On any occasion of absence, the amount of playing time for which the player is off the field shall be added to any Penalty time that remains unserved, subject to a maximum cumulative Penalty time of 35 minutes, and that player shall not bowl until all of her Penalty time has been served.
- 24.2.6 For the purposes of clauses 24.2.3.1 and 24.2.3.2, playing time shall comprise the time play is in progress excluding intervals, intervals between innings and official drinks intervals. For clarity, a player's Penalty time will continue to expire after she is dismissed, for the remainder of her team's batting innings.
- 24.2.7 If there is an unscheduled break in play, the stoppage time shall count as Penalty time served, provided that,
- 24.2.7.1 the fielder who was on the field of play at the start of the break either takes the field on the resumption of play, or her side is now batting.
- 24.2.7.2 the fielder who was already off the field at the start of the break notifies an umpire in person as soon as she is able to participate, and either takes the field on the resumption of play, or her side is now batting. Stoppage time before an umpire has been so notified shall not count towards unserved Penalty time.
- 24.2.8 Any unserved Penalty time shall be carried forward into the next innings of the match, as applicable.

24.3 Penalty time not incurred

- A nominated player's absence will not incur Penalty time if,
- 24.3.1 she has suffered an external blow during the match and, as a result, has justifiably left the field or is unable to take the field.
- 24.3.2 in the opinion of the umpires, the player has been absent or has left the field for other wholly acceptable reasons, which shall not include illness or internal injury.
- 24.3.3 the player is absent from the field for a period of 8 minutes or less.

24.4 Player returning without permission

If a player comes on to the field of play in contravention of clause 24.2.2 and comes into contact with the ball while it is in play, the ball shall immediately become dead.

- The umpire shall award 5 Penalty runs to the batting side.
- Runs completed by the batters shall be scored together with the run in progress if they had already crossed at the instant of the offence.
- The ball shall not count as one of the over.
- The umpire shall inform the other umpire, the captain of the fielding side, the batters and, as soon as practicable, the captain of the batting side of the reason for this action.

25 BATTER'S INNINGS**25.1 Eligibility to act as a batter**

Only a nominated player may bat and, subject to clause 25.3, may do so even though a substitute fielder has previously acted for her.

25.2 Commencement of a batter's innings

The innings of the first two batters, and that of any new batter on the resumption of play after a call of Time, shall commence at the call of Play. At any other time, a batter's innings shall be considered to have commenced when that batter first steps onto the field of play.

25.3 Restriction on batter commencing an innings

- 25.3.1 If a member of the batting side has unserved Penalty time, see clause 24.2.7, that player shall not be permitted to bat until that Penalty time has been served. However, even if the unserved Penalty time has not expired, that player may bat after her side has lost 5 wickets.
- 25.3.2 A member of the batting side's Penalty time is served during Playing time, in the event of an unscheduled stoppage, the stoppage time after the batter notifies an umpire in person that she is able to participate shall count as Penalty time served.

25.4 Batter retiring

- 25.4.1 A batter may retire at any time during her innings when the ball is dead. The umpires, before allowing play to proceed, shall be informed of the reason for a batter retiring.
- 25.4.2 If a batter retires because of illness, injury or any other unavoidable cause, that batter is entitled to resume her innings. If for any reason this does not happen, that batter is to be recorded as 'Retired – not out'.
- 25.4.3 If a batter retires for any reason other than as in clause 25.4.2, the innings of that batter may be resumed only with the consent of the opposing captain. If for any reason her innings is not resumed, that batter is to be recorded as 'Retired – out'.
- 25.4.4 If after retiring a batter resumes her innings, subject to the requirements of clauses 25.4.2 and 25.4.3, it shall be only at the fall of a wicket or the retirement of another batter.

25.5 Runners

Runners shall not be permitted.

26 PRACTICE ON THE FIELD**26.1 Practice on the pitch or the rest of the square**

- 26.1.1 There shall not be any practice on the pitch at any time.
- 26.1.2 There shall not be any practice on the rest of the square at any time except with the approval of the umpires.
- 26.1.2.1 If approved by the umpires, the use of the square for practice on any day of any match will be restricted to any netted practice area or bowling strips specifically prepared on the edge of the square for that purpose.
- 26.1.2.2 Bowling practice on the bowling strips referred to above shall also be permitted during the interval (and change of innings if not the interval) unless the umpires consider that, in the prevailing conditions of ground and weather, it will be detrimental to the surface of the square.

26.2 Practice on the outfield

- 26.2.1 On any day of the match, all forms of practice are permitted on the outfield
- before the start of play
 - after the close of play, and
 - during the interval or between innings
- providing the umpires are satisfied that such practice will not cause significant deterioration in the condition of the outfield.
- 26.2.2 Between the call of Play and the call of Time, practice shall be permitted on the outfield, providing that all of the following conditions are met:
- only the fielders as defined in paragraph 7 of Appendix A participate in such practice.
 - no ball other than the match ball is used for this practice.
 - no bowling practice takes place in the area between the square and the boundary in a direction parallel to the match pitch.
 - the umpires are satisfied that it will not contravene either of clauses 41.3 (The match ball changing its condition) or 41.9 (Time wasting by the fielding side).

Bowling a ball, using a short run up to a player in the outfield is not to be regarded as bowling practice but shall be subject to the other conditions in this clause.

26.3 Trial run-up

A bowler is permitted to have a trial run-up provided the umpire is satisfied that it will not contravene either of clauses 41.9 (Time wasting by the fielding side) or 41.12 (Fielder damaging the pitch).

26.4 Penalties for contravention

All forms of practice are subject to the provisions of clauses 41.3 (The match ball – changing its condition), 41.9 (Time wasting by the fielding side) and 41.12 (Fielder damaging the pitch).

26.4.1 If there is a contravention of any of the provisions of clause 26.1 or 26.2, the umpire shall

- warn the player that the practice is not permitted;
- inform the other umpire and, as soon as practicable, both captains of the reason for this action.

26.4.1.1 If the contravention is by a batter at the wicket, the umpire shall inform the other batter and each incoming batter that the warning has been issued. The warning shall apply to the team of that player throughout the match.

26.4.2 If during the match there is any further contravention by any player of that team, the umpire shall

- award 5 Penalty runs to the opposing side;
- inform the other umpire, the scorers and, as soon as practicable, both captains, and, if the contravention is during play, the batters at the wicket.

27 THE WICKET-KEEPER**27.1 Protective equipment**

The wicket-keeper is the only fielder permitted to wear gloves and external leg guards. If these are worn, they are to be regarded as part of her person for the purposes of clause 28.2 (Fielding the ball). If by the wicket-keeper's actions and positioning when the ball comes into play it is apparent to the umpires that she will not be able to carry out the normal duties of a wicket-keeper, she shall forfeit this right and also the right to be recognised as a wicket-keeper for the purposes of clauses 33.2 (A fair catch), 39 (Stumped), 28.1 (Protective equipment), 28.4 (Limitation of on-side fielders) and 28.5 (Fielders not to encroach on pitch).

27.2 Gloves

27.2.1 If, as permitted under clause 27.1, the wicket-keeper wears gloves, they shall have no webbing between the fingers except joining index finger and thumb, where webbing may be inserted as a means of support.

27.2.2 If used, the webbing shall be a single piece of non-stretch material which, although it may have facing material attached, shall have no reinforcements or tucks.

27.2.3 The top edge of the webbing shall not protrude beyond the straight line joining the top of the index finger to the top of the thumb and shall be taut when a hand wearing the glove has the thumb fully extended. See paragraph 3 of Appendix B.

27.3 Position of wicket-keeper

27.3.1 The wicket-keeper shall remain wholly behind the wicket at the striker's end from the moment the ball comes into play until a ball delivered by the bowler

touches the bat or person of the striker, or

passes the wicket at the striker's end, or

the striker attempts a run.

27.3.2 In the event of the wicket-keeper contravening this clause, the striker's end umpire shall call and signal No ball as soon as applicable after the delivery of the ball.

27.4 Movement by wicket-keeper

27.4.1 After the ball comes into play and before it reaches the striker, it is unfair if the wicket-keeper significantly alters her position in relation to the striker's wicket, except for the following:

27.4.1.1 movement of a few paces forward for a slower delivery, unless in so doing it brings her within reach of the wicket.

27.4.1.2 lateral movement in response to the direction in which the ball has been delivered.

27.4.1.3 movement in response to the stroke that the striker is playing or that her actions suggest she intends to play. However the provisions of clause 27.3 shall apply.

27.4.2 In the event of unfair movement by the wicket-keeper, either umpire shall call and signal Dead ball.

27.5 Restriction on actions of wicket-keeper

If, in the opinion of either umpire, the wicket-keeper interferes with the striker's right to play the ball and to guard her wicket, clause 20.4.2.6 (Umpire calling and signalling Dead ball) shall apply.

If, however, either umpire considers that the interference by the wicket-keeper was wilful, then clause 41.4 (Deliberate attempt to distract striker) shall also apply.

27.6 Interference with wicket-keeper by striker

If, in playing at the ball or in the legitimate defence of her wicket, the striker interferes with the wicket-keeper, she shall not be out except as provided for in clause 37.3 (Obstructing a ball from being caught).

28 THE FIELDER**28.1 Protective equipment**

No fielder other than the wicket-keeper shall be permitted to wear gloves or external leg guards. In addition, protection for the hand or fingers may be worn only with the consent of the umpires.

28.2 Fielding the ball

28.2.1 A fielder may field the ball with any part of her person (see paragraph 12 of Appendix A), except as in clause 28.2.1.2. However, she will be deemed to have fielded the ball illegally if, while the ball is in play she wilfully

28.2.1.1 uses anything other than part of her person to field the ball.

28.2.1.2 extends her clothing with her hands and uses this to field the ball.

28.2.1.3 discards a piece of clothing, equipment or any other object which subsequently makes contact with the ball.

28.2.2 It is not illegal fielding if the ball in play makes contact with a piece of clothing, equipment or any other object which has accidentally fallen from the fielder's person.

28.2.3 If a fielder illegally fields the ball, the ball shall immediately become dead and

- the penalty for a No ball or a Wide shall stand.
- any runs completed by the batters shall be credited to the batting side, together with the run in progress if the batters had already crossed at the instant of the offence.
- the ball shall not count as one of the over.

In addition the umpire shall:

- award 5 Penalty runs to the batting side.
- inform the other umpire and the captain of the fielding side of the reason for this action.
- inform the batters and, as soon as practicable, the captain of the batting side of what has occurred.

28.3 Protective helmets belonging to the fielding side

28.3.1 Protective helmets, when not in use by fielders, may not be placed on the ground, above the surface except behind the wicket-keeper and in line with both sets of stumps.

28.3.2 If the ball while in play strikes a helmet, placed as described in clause 28.3.1,

28.3.2.1 the ball shall become dead and, subject to clause 28.3.3,

28.3.2.2 an award of 5 Penalty runs shall be made to the batting side;

28.3.2.3 any runs completed by the batters before the ball strikes the protective helmet shall be scored, together with the run in progress if the batters had already crossed at the instant of the ball striking the protective helmet.

28.3.3 If the ball while in play strikes a helmet, placed as described in clause 28.3.1, unless the circumstances of clause 23.3 (Leg byes not to be awarded) or clause 34 (Hit the ball twice), apply, the umpire shall:

- permit the batters's runs as in clause 28.3.2.3 to be scored
- signal No ball or Wide ball to the scorers if applicable
- award 5 Penalty runs as in clause 28.3.2.2
- award any other Penalty runs due to the batting side.

28.3.4 If the ball while in play strikes a helmet, placed as described in clause 28.3.1, and the circumstances of clause 23.3 (Leg byes not to be awarded) or clause 34 (Hit the ball twice) apply, the umpire shall:

- disallow all runs to the batting side
- return any not out batter to her original end
- signal No ball or Wide ball to the scorers if applicable
- award any 5-run Penalty that is applicable except for Penalty runs under clause 28.3.2.

28.4 Limitation of on side fielders

28.4.1 At the instant of delivery, there may not be more than 5 fielders on the leg side.

28.4.2 At the instant of the bowler's delivery there shall not be more than two fielders, other than the wicket-keeper, behind the popping crease on the on side. A fielder will be considered to be behind the popping crease unless the whole of her person whether grounded or in the air is in front of this line.

28.4.3 In the event of infringement of this clause by any fielder, the striker's end umpire shall call and signal No ball.

28.5 Fielders not to encroach on pitch

While the ball is in play and until the ball has made contact with the striker's bat or person, or has passed the striker's bat, no fielder, other than the bowler, may have any part of her person grounded on or extended over the pitch.

In the event of infringement of this clause by any fielder other than the wicket-keeper, the bowler's end umpire shall call and signal No ball as soon as possible after delivery of the ball. Note, however, clause 27.3 (Position of wicket-keeper).

28.6 Movement by any fielder other than the wicket-keeper

- 28.6.1 Any movement by any fielder, excluding the wicket-keeper, after the ball comes into play and before the ball reaches the striker, is unfair except for the following:
- 28.6.1.1 minor adjustments to stance or position in relation to the striker's wicket.
- 28.6.1.2 movement by any fielder, other than a close fielder, towards the striker or the striker's wicket that does not significantly alter the position of the fielder.
- 28.6.1.3 movement by any fielder in response to the stroke that the striker is playing or that her actions suggest she intends to play.
- 28.6.2 In all circumstances clause 28.4 (Limitation of on side fielders) shall apply.
- 28.6.3 In the event of such unfair movement, either umpire shall call and signal Dead ball.
- 28.6.4 Note also the provisions of clause 41.4 (Deliberate attempt to distract striker). See also clause 27.4 (Movement by wicket-keeper).

28.7 Restrictions on the placement of fielders

- 28.7.1 In addition to the restrictions contained in clause 28.4 above, further fielding restrictions shall apply to certain overs in each innings. The nature of such fielding restrictions and the overs during which they shall apply are set out in the following paragraphs.
- 28.7.2 Subject to 28.7.6 below these additional fielding restrictions shall apply to the first 6 overs of each innings (Powerplay overs).
- 28.7.3 The following fielding restrictions shall apply:
- 28.7.3.1 Two semi-circles shall be drawn on the field of play. The semi-circles shall have as their centre the middle stump at either end of the pitch. The radius of each of the semi-circles shall be 25.15 yards (23 metres). The semi-circles shall be linked by two parallel straight lines drawn on the field. (Refer to paragraph 2 of Appendix C). The fielding restriction areas should be marked by continuous painted white lines or 'dots' at 5 yard (4.57 metres) intervals, each 'dot' to be covered by a white plastic or rubber (but not metal) disc measuring 7 inches (18 cm) in diameter.
- 28.7.4 During the Powerplay overs only two fielders shall be permitted outside this fielding restriction area at the instant of delivery.
- 28.7.5 During the non Powerplay overs, no more than four fielders shall be permitted outside the fielding restriction area referred to in clause 28.7.3 above.

- 28.7.6 In circumstances when the number of overs of the batting team is reduced, the number of Powerplay overs shall be reduced in accordance with the table below. For the sake of clarity, it should be noted that the table shall apply to both the 1st and 2nd innings of the match.

TOTAL OVERS IN INNINGS	NUMBER OF OVERS FOR WHICH FIELDING RESTRICTIONS IN CLAUSES 28.7.2 AND 28.7.4 ABOVE WILL APPLY
5-8	2
9-11	3
12-14	4
15-18	5
19-20	6

- 28.7.7 If an innings is interrupted during an over and if on the resumption of play, due to the reduced number of overs of the batting team, the required number of Powerplay overs have already been bowled, the remaining deliveries in the over to be completed shall not be subject to the fielding restrictions.
- 28.7.7.1 In the event of an infringement of any of the above fielding restrictions, the square leg umpire shall call and signal 'No Ball'.

29 THE WICKET IS DOWN**29.1 Wicket put down**

- 29.1.1 The wicket is put down if a bail is completely removed from the top of the stumps, or a stump is struck out of the ground,
- 29.1.1.1 by the ball,
- 29.1.1.2 by the striker's bat if held or by any part of the bat that she is holding,
- 29.1.1.3 for the purpose of this clause only, by the striker's bat not in hand, or by any part of the bat which has become detached,
- 29.1.1.4 by the striker's person or by any part of her clothing or equipment becoming detached from her person,
- 29.1.1.5 by a fielder with her hand or arm, providing that the ball is held in the hand or hands so used, or in the hand of the arm so used.
- 29.1.1.6 The wicket is also put down if a fielder strikes or pulls a stump out of the ground as in clause 29.1.1.5.
- 29.1.2 The disturbance of a bail, whether temporary or not, shall not constitute its complete removal from the top of the stumps, but if a bail in falling lodges between two of the stumps this shall be regarded as complete removal.

29.2 One bail off

If one bail is off, it shall be sufficient for the purpose of putting the wicket down to remove the remaining bail or to strike or pull any of the three stumps out of the ground, in any of the ways stated in clause 29.1.

29.3 Remaking wicket

If a wicket is broken or put down while the ball is in play, it shall not be remade by an umpire until the ball is dead. See clause 20 (Dead ball). Any fielder may, however, while the ball is in play,

- replace a bail or bails on top of the stumps.
- put back one or more stumps into the ground where the wicket originally stood.

29.4 Dispensing with bails

If the umpires have agreed to dispense with bails in accordance with clause 8.4 (Dispensing with bails), it is for the umpire concerned to decide whether or not the wicket has been put down.

- 29.4.1 After a decision to play without bails, the wicket has been put down if the umpire concerned is satisfied that the wicket has been struck by the ball, by the striker's bat, person or items of her clothing or equipment as described in clauses 29.1.1.2, 29.1.1.3 or 29.1.1.4, or by a fielder in the manner described in clause 29.1.1.5.
- 29.4.2 If the wicket has already been broken or put down, clause 29.4.1 shall apply to any stump or stumps still in the ground. Any fielder may replace a stump or stumps, in accordance with clause 29.3, in order to have an opportunity of putting the wicket down.

30 BATTER OUT OF HER GROUND**30.1 When out of her ground**

- 30.1.1 A batter shall be considered to be out of her ground unless some part of her person or bat is grounded behind the popping crease at that end.
- 30.1.2 However, a batter shall not be considered to be out of her ground if, in running or diving towards her ground and beyond, and having grounded some part of her person or bat beyond the popping crease, there is subsequent loss of contact between the ground and any part of her person or bat, or between the bat and person.

30.2 Which is a batter's ground

- 30.2.1 If only one batter is within a ground, it is her ground and will remain so even if she is later joined there by the other batter.
- 30.2.2 If both batters are in the same ground and one of them subsequently leaves it, the ground belongs to the batter who remains in it.

30.2.3 If there is no batter in either ground, then each ground belongs to whichever batter is nearer to it, or, if the batters are level, to whichever batter was nearer to it immediately prior to their drawing level.

30.2.4 If a ground belongs to one batter then the other ground belongs to the other batter, irrespective of her position.

30.3 Position of non-striker

The non-striker, when standing at the bowler's end, should be positioned on the opposite side of the wicket to that from which the ball is being delivered, unless a request to do otherwise is granted by the umpire.

31 APPEALS**31.1 Umpire not to give batter out without an appeal**

Neither umpire shall give a batter out, even though she may be out under these Playing Conditions, unless appealed to by a fielder. This shall not debar a batter who is out under these Playing Conditions from leaving the wicket without an appeal having been made. Note, however, the provisions of clause 31.7.

31.2 Batter dismissed

A batter is dismissed if she is either given out by an umpire, on appeal or out under these Playing Conditions and leaves the wicket as in clause 31.1.

31.3 Timing of appeals

For an appeal to be valid, it must be made before the bowler begins her run-up or, if there is no run-up, her bowling action to deliver the next ball, and before Time has been called.

The call of Over does not invalidate an appeal made prior to the start of the following over, provided Time has not been called. See clauses 12.2 (Call of Time) and 17.2 (Start of an over).

31.4 Appeal "How's That?"

An appeal "How's That?" covers all ways of being out.

31.5 Answering appeals

The striker's end umpire shall answer all appeals arising out of any of clauses 35 (Hit wicket), 39 (Stumped) or 38 (Run out) when this occurs at the wicket-keeper's end. The bowler's end umpire shall answer all other appeals.

When an appeal is made, each umpire shall answer on any matter that falls within his/her jurisdiction.

When a batter has been given Not out, either umpire may answer an appeal, made in accordance with clause 31.3, if it is on a further matter and is within his/her jurisdiction.

31.6 Consultation by umpires

Each umpire shall answer appeals on matters within his/her own jurisdiction. If an umpire is doubtful about any point that the other umpire may have been in a better position to see, he/she shall consult the latter on this point of fact and shall then give the decision. If, after consultation, there is still doubt remaining, the decision shall be Not out.

31.7 Batter leaving the wicket under a misapprehension

An umpire shall intervene if satisfied that a batter, not having been given out, has left the wicket under a misapprehension of being out. The umpire intervening shall call and signal Dead ball to prevent any further action by the fielding side and shall recall the batter.

A batter may be recalled at any time up to the instant when the ball comes into play for the next delivery, unless it is the final wicket of the innings, in which case it should be up to the instant when the umpires leave the field.

31.8 Withdrawal of an appeal

The captain of the fielding side may withdraw an appeal only after obtaining the consent of the umpire within whose jurisdiction the appeal falls. If such consent is given, the umpire concerned shall, if applicable, revoke the decision and recall the batter.

The withdrawal of an appeal must be before the instant when the ball comes into play for the next delivery or, if the innings has been completed, the instant when the umpires leave the field.

32 BOWLED**32.1 Out Bowled**

32.1.1 The striker is out Bowled if her wicket is put down by a ball delivered by the bowler, not being a No ball, even if it first touches the striker's bat or person.

32.1.2 However, the striker shall not be out Bowled if before striking the wicket the ball has been in contact with any other player or an umpire. The striker will, however, be subject to clauses 37 (Obstructing the field), 38 (Run out) and 39 (Stumped).

32.2 Bowled to take precedence

The striker is out Bowled if her wicket is put down as in clause 32.1, even though a decision against her for any other method of dismissal would be justified.

33 CAUGHT**33.1 Out Caught**

The striker is out Caught if a ball delivered by the bowler, not being a No ball, touches her bat without having previously been in contact with any fielder, and is subsequently held by a fielder as a fair catch, as described in clauses 33.2 and 33.3, before it touches the ground.

33.2 A fair catch

33.2.1 A catch will be fair only if, in every case either the ball, at any time

or any fielder in contact with the ball,

is not grounded beyond the boundary before the catch is completed. Note clauses 19.4 (Ball grounded beyond the boundary) and 19.5 (Fielder grounded beyond the boundary).

33.2.2 Furthermore, a catch will be fair if any of the following conditions applies:

33.2.2.1 the ball is held in the hand or hands of a fielder, even if the hand holding the ball is touching the ground, or is hugged to the body, or lodges in the external protective equipment worn by a fielder, or lodges accidentally in a fielder's clothing.

33.2.2.2 a fielder catches the ball after it has been lawfully struck more than once by the striker, but only if it has not been grounded since it was first struck. See clause 34 (Hit the ball twice).

33.2.2.3 a fielder catches the ball after it has touched the wicket, an umpire, another fielder or the other batter.

33.2.2.4 a fielder catches the ball after it has crossed the boundary in the air, provided that the conditions in clause 33.2.1 are met.

33.2.2.5 the ball is caught off an obstruction within the boundary that is not designated a boundary by the umpires.

33.3 Making a catch

The act of making a catch shall start from the time when the ball first comes into contact with a fielder's person and shall end when a fielder obtains complete control over both the ball and her own movement.

33.4 No runs to be scored

If the striker is dismissed Caught, runs from that delivery completed by the batters before the completion of the catch shall not be scored but any runs for penalties awarded to either side shall stand. Clause 18.12 (Batter returning to the wicket she has left) shall apply from the instant of the completion of the catch.

33.5 Caught to take precedence

If the criteria of clause 33.1 are met and the striker is not out Bowled, then she is out Caught, even though a decision against either batter for another method of dismissal would be justified.

34 HIT THE BALL TWICE**34.1 Out Hit the ball twice**

- 34.1.1 The striker is out Hit the ball twice if, while the ball is in play, it strikes any part of her person or is struck by her bat and, before the ball has been touched by a fielder, the striker wilfully strikes it again with her bat or person, other than a hand not holding the bat, except for the sole purpose of guarding her wicket. See clause 34.3 and clause 37 (Obstructing the field).
- 34.1.2 For the purpose of this clause 'struck' or 'strike' shall include contact with the person of the striker.

34.2 Not out Hit the ball twice

The striker will not be out under this clause if she

- 34.2.1 strikes the ball a second or subsequent time in order to return the ball to any fielder.
Note, however, the provisions of clause 37.4 (Returning the ball to a fielder).
- 34.2.2 wilfully strikes the ball after it has touched a fielder. Note, however the provisions of clause 37.1 (Out Obstructing the field).

34.3 Ball lawfully struck more than once

The striker may, solely in order to guard her wicket and before the ball has been touched by a fielder, lawfully strike the ball a second or subsequent time with the bat, or with any part of her person other than a hand not holding the bat. The striker may guard her wicket even if the delivery is a No ball.

However, the striker may not prevent the ball from being caught by striking the ball more than once in defence of her wicket. See clause 37.3 (Obstructing a ball from being caught).

34.4 Runs permitted from ball lawfully struck more than once

When the ball is lawfully struck more than once, as permitted in clause 34.3, if the ball does not become dead for any reason, the umpire shall call and signal Dead ball as soon as the ball reaches the boundary or at the completion of the first run. However, the umpire shall delay the call of Dead ball to allow the opportunity for a catch to be completed.

The umpire shall

- disallow all runs to the batting side
- return any not out batter to her original end
- signal No ball to the scorers if applicable, and
- award any 5-run Penalty that is applicable except for Penalty runs under clause 28.3 (Protective helmets belonging to the fielding side).

34.5 Bowler does not get credit

The bowler does not get credit for the wicket.

35 HIT WICKET**35.1 Out Hit wicket**

- 35.1.1 The striker is out Hit wicket if, after the bowler has entered the delivery stride and while the ball is in play, her wicket is put down by either the striker's bat or person as described in clauses 29.1.1.2 to 29.1.1.4 (Wicket put down) in any of the following circumstances:
- 35.1.1.1 in the course of any action taken by her in preparing to receive or in receiving a delivery,
- 35.1.1.2 in setting off for the first run immediately after playing or playing at the ball,
- 35.1.1.3 if no attempt is made to play the ball, in setting off for the first run, providing that in the opinion of the umpire this is immediately after the striker has had the opportunity of playing the ball,
- 35.1.1.4 in lawfully making a second or further stroke for the purpose of guarding her wicket within the provisions of clause 34.3 (Ball lawfully struck more than once).
- 35.1.2 If the striker puts her wicket down in any of the ways described in clauses 29.1.1.2 to 29.1.1.4 before the bowler has entered the delivery stride, either umpire shall call and signal Dead ball.

35.2 Not out Hit wicket

The striker is not out under this clause should her wicket be put down in any of the ways referred to in clause 35.1 if any of the following applies:

- it occurs after the striker has completed any action in receiving the delivery, other than in clauses 35.1.1.2 to 35.1.1.4.
- it occurs when the striker is in the act of running, other than setting off immediately for the first run.
- it occurs when the striker is trying to avoid being run out or stumped.
- it occurs when the striker is trying to avoid a throw in at any time.
- the bowler after entering the delivery stride does not deliver the ball. In this case either umpire shall immediately call and signal Dead ball. See clause 20.4 (Umpire calling and signalling Dead ball).
- the delivery is a No ball.

36 LEG BEFORE WICKET**36.1 Out LBW**

The striker is out LBW if all the circumstances set out in clauses 36.1.1 to 36.1.5 apply.

- 36.1.1 The bowler delivers a ball, not being a No ball
- 36.1.2 the ball, if it is not intercepted full-pitch, pitches in line between wicket and wicket or on the off side of the striker's wicket
- 36.1.3 the ball not having previously touched her bat, the striker intercepts the ball, either full-pitch or after pitching, with any part of her person

- 36.14 the point of impact, even if above the level of the bails, either is between wicket and wicket or if the striker has made no genuine attempt to play the ball with the bat, is between wicket and wicket or outside the line of the off stump.
- 36.15 but for the interception, the ball would have hit the wicket.

36.2 Interception of the ball

- 36.2.1 In assessing points of impact in clauses 36.1.3, 36.1.4 and 36.1.5, only the first interception is to be considered.
- 36.2.2 In assessing clause 36.1.3, if the bowler's end umpire is not satisfied that the ball intercepted the batter's person before it touched the bat, the batter shall be given Not out.
- 36.2.3 In assessing clause 36.1.5, it is to be assumed that the path of the ball before interception would have continued after interception, irrespective of whether the ball might have pitched subsequently or not.

36.3 Off side of wicket

The off side of the striker's wicket shall be determined by the striker's stance at the moment the ball comes into play for that delivery. See paragraph 13 of Appendix A.

37 OBSTRUCTING THE FIELD

37.1 Out Obstructing the field

- 37.1.1 Either batter is out Obstructing the field if, except in the circumstances of clause 37.2, and while the ball is in play, she wilfully attempts to obstruct or distract the fielding side by word or action. See also clause 34 (Hit the ball twice).
- 37.1.2 The striker is out Obstructing the field if, except in the circumstances of clause 37.2, in the act of receiving a ball delivered by the bowler, she wilfully strikes the ball with a hand not holding the bat. This will apply whether it is the first strike or a second or subsequent strike. The act of receiving the ball shall extend both to playing at the ball and to striking the ball more than once in defence of her wicket.
- 37.1.3 This clause will apply whether or not No ball is called.
- 37.1.4 For the avoidance of doubt, if an umpire feels that a batter, in running between the wickets, has significantly changed her direction without probable cause and thereby obstructed a fielder's attempt to effect a run out, the batter should, on appeal, be given out, obstructing the field. It shall not be relevant whether a run out would have occurred or not.
- If the change of direction involves the batter crossing the pitch, clause 41.14 shall also apply.
- See also paragraph 2.2 of Appendix D.

37.2 Not out Obstructing the field

A batter shall not be out Obstructing the field if obstruction or distraction is accidental, or obstruction is in order to avoid injury, or in the case of the striker, she makes a second or subsequent strike to guard her wicket lawfully as in clause 34.3 (Ball lawfully struck more than once). However, see clause 37.3.

37.3 Obstructing a ball from being caught

- 37.3.1 If the delivery is not a No ball, the striker is out Obstructing the field if wilful obstruction or distraction by either batter prevents the striker being out caught.
- 37.3.2 Clause 37.3.1 shall apply even if an obstruction is caused by the striker in lawfully guarding her wicket under the provision of Clause 34.3 (Ball lawfully struck more than once).
- 37.3.3 If an obstruction or distraction takes place from a No ball then the batter who caused the obstruction or distraction will be out Obstructing the field.
- 37.3.4 Clause 37.3.3 shall not apply if the striker obstructs while instinctively defending her wicket with a lawful second strike

37.4 Returning the ball to a fielder

Either batter is out Obstructing the field if, at any time while the ball is in play and, without the consent of a fielder, she uses the bat or any part of her person to return the ball to any fielder.

37.5 Runs scored

When either batter is dismissed Obstructing the field,

- 37.5.1 unless the obstruction prevents a catch from being made, any runs completed by the batters before the offence shall be scored, together with any runs awarded for penalties to either side. See clauses 18.6 (Runs awarded for penalties) and 18.8 (Runs scored when a batter is dismissed).
- 37.5.2 if the obstruction prevents a catch from being made, any runs completed by the batters shall not be scored but any penalties awarded to either side shall stand.

37.6 Bowler does not get credit

The bowler does not get credit for the wicket.

38 RUN OUT**38.1 Out Run out**

Either batter is out Run out, except as in clause 38.2, if, at any time while the ball is in play,

she is out of her ground

and her wicket is fairly put down by the action of a fielder

even though No ball has been called, except in the circumstances of clause 38.2.2.2, and whether or not a run is being attempted.

38.2 Batter not out Run out

38.2.1 A batter is not out Run out in the circumstances of clauses 38.2.1.1 or 38.2.1.2.

38.2.1.1 She has been within her ground and has subsequently left it to avoid injury, when the wicket is put down.

Note also the provisions of clause 30.1.2 (When out of her ground).

38.2.1.2 The ball delivered by the bowler has not made contact with a fielder, before the wicket is put down.

38.2.2 The striker is not out Run out in any of the circumstances in clauses 38.2.2.1 and 38.2.2.2.

38.2.2.1 She is out Stumped. See clause 39.1.2 (Out Stumped).

38.2.2.2 No ball has been called
and she is out of her ground not attempting a run
and the wicket is fairly put down by the wicket-keeper without the intervention of another fielder.

38.3 Which batter is out

The batter out in the circumstances of clause 38.1 is the one whose ground is at the end where the wicket is put down. See clause 30.2 (Which is a batter's ground).

38.4 Runs scored

If either batter is dismissed Run out, the run in progress when the wicket is put down shall not be scored, but any runs completed by the batters shall stand, together with any runs for penalties awarded to either side. See clauses 18.6 (Runs awarded for penalties) and 18.8 (Runs scored when a batter is dismissed).

38.5 Bowler does not get credit

The bowler does not get credit for the wicket.

39 STUMPED**39.1 Out Stumped**

39.1.1 The striker is out Stumped, except as in clause 39.3, if a ball which is delivered is not called No ball and she is out of her ground, other than as in clause 39.3.1 and she has not attempted a run

when her wicket is fairly put down by the wicket-keeper without the intervention of another fielder. Note, however clause 27.3 (Position of wicket-keeper).

39.1.2 The striker is out Stumped if all the conditions of clause 39.1.1 are satisfied, even though a decision of Run out would be justified.

39.2 Ball rebounding from wicket-keeper's person

If the wicket is put down by the ball, it shall be regarded as having been put down by the wicket-keeper if the ball rebounds on to the stumps from any part of the wicket-keeper's person or equipment or has been kicked or thrown on to the stumps by the wicket-keeper.

39.3 Not out Stumped

39.3.1 The striker will not be out Stumped if, after having received the delivery, she has left her ground in order to avoid injury.

39.3.2 If the striker is not out Stumped she may, except in the circumstances of clause 38.2.2.2 (Batter not out run out) be out Run out if the conditions of clause 38.1 (Out Run out) apply.

40 TIMED OUT**40.1 Out Timed out**

40.1.1 After the fall of a wicket or the retirement of a batter, the incoming batter must, unless Time has been called, be in position to take guard or for the other batter to be ready to receive the next ball within 1 minute 30 seconds of the dismissal or retirement. If this requirement is not met, the incoming batter will be out, Timed out.

40.1.2 The incoming batter is expected to be ready to make her way to the wicket immediately a wicket falls. Dugouts shall be provided.

40.1.3 In the event of an extended delay in which no batter comes to the wicket, the umpires shall adopt the procedure of clause 16.2 (ICC Match Referee awarding a match). For the purposes of that clause the start of the action shall be taken as the expiry of the 1 minute 30 seconds referred to above.

40.2 Bowler does not get credit

The bowler does not get credit for the wicket.

41 UNFAIR PLAY**41.1 Fair and unfair play – responsibility of captains**

The captains are responsible for ensuring that play is conducted within the Spirit of Cricket, as well as within these Playing Conditions.

41.2 Fair and unfair play – responsibility of umpires

41.2.1 The umpires shall be the sole judges of fair and unfair play. If either umpire considers that any action by a player, not covered by these Playing Conditions, is unfair, he/she shall call and signal Dead ball, if appropriate, as soon as it becomes clear that the call will not disadvantage the non-offending side, and report the matter to the other umpire.

41.2.1.1 If this is a first offence by that side, the bowler's end umpire shall then

- summon the offending player's captain and issue a first and final warning which shall apply to all members of the team for the remainder of the match.
- warn the offending player's captain that any further such offence by any member of her team shall result in the award of 5 Penalty runs to the opposing team.

41.2.1.2 If this is a second or subsequent offence by that side the bowler's end umpire shall then

- summon the offending player's captain and inform her that there has been a further such offence.
- award 5 Penalty runs to the opposing side.

41.2.1.3 The umpires shall may then report the matter to the ICC Match Referee who shall take such action as is considered appropriate against the player concerned.

41.3 The match ball – changing its condition

41.3.1 The umpires shall make frequent and irregular inspections of the ball. In addition, they shall immediately inspect the ball if they suspect anyone of attempting to change the condition of the ball, except as permitted in clause 41.3.2.

41.3.2 It is an offence for any player to take any action which changes the condition of the ball.

Except in carrying out her normal duties, a batter is not allowed to wilfully damage the ball other than, when the ball is in play, in striking it with the bat. See also clause 5.5 (Damage to the ball).

A fielder may, however:

41.3.2.1 polish the ball on her clothing provided that no artificial substance is used and that such polishing wastes no time.

41.3.2.2 remove mud from the ball under the supervision of an umpire.

41.3.2.3 dry a wet ball on a piece of cloth that has been approved by the umpires.

41.3.3 The umpires shall consider the condition of the ball to have been unfairly changed if any action by any player does not comply with the conditions in clause 41.3.2.

41.3.4 If the umpires together agree that the condition of the ball has been unfairly changed by a member or members of either side, or that its condition is inconsistent with the use it has received, they shall consider that there has been a contravention of this clause and decide together whether they can identify the player(s) responsible for such conduct.

41.3.5 If it is possible to identify the player(s) responsible for changing the condition of the ball, the umpires shall;

41.3.5.1 Change the ball forthwith.

41.3.5.1.1 If the umpires together agree that the condition of the ball has been unfairly changed by a member or members of the fielding side, the batter at the wicket shall choose the replacement ball from a selection of six other balls of various degrees of usage (including a new ball) and of the same brand as the ball in use prior to the contravention.

41.3.5.1.2 If the umpires together agree that the condition of the ball has been unfairly changed by a member or members of the batting side, the umpires shall select and bring into use immediately, a ball which shall have wear comparable to that of the previous ball immediately prior to the contravention.

41.3.5.2 Additionally, the bowler's end umpire shall

- award 5 Penalty runs to the opposing side.
- if appropriate, inform the batters at the wicket and the captain of the fielding side that the ball has been changed and the reason for their action.
- inform the captain of the batting side as soon as practicable of what has occurred.

The umpires shall then report the matter to the ICC Match Referee who shall take such action as is considered appropriate against the player(s) concerned.

41.3.6 If it is not possible to identify the player(s) responsible for changing the condition of the ball, the umpires shall;

41.3.6.1 Change the ball forthwith. The umpires shall choose the replacement ball for one of similar wear and of the same brand as the ball in use prior to the contravention.

- 41.3.6.2 The bowler's end umpire shall issue the captain with a first and final warning, and
- 41.3.6.3 Advise the captain that should there be any further instances of changing the condition of the ball by that team during the remainder of the series, clause 41.3.5.2 above will be adopted, with the captain deemed to be the player responsible for the contravention.

41.4 Deliberate attempt to distract striker

- 41.4.1 It is unfair for any fielder deliberately to attempt to distract the striker while she is preparing to receive or receiving a delivery.
- 41.4.2 If either umpire considers that any action by a fielder is such an attempt, he/she shall immediately call and signal Dead ball and inform the other umpire of the reason for the call. The bowler's end umpire shall
- award 5 Penalty runs to the batting side.
 - inform the captain of the fielding side, the batters and, as soon as practicable, the captain of the batting side of the reason for the action.

Neither batter shall be dismissed from that delivery and the ball shall not count as one of the over.

The umpires may then report the matter to the ICC Match Referee who shall take such action as is considered appropriate against the fielder concerned.

41.5 Deliberate distraction, deception or obstruction of batter

- 41.5.1 In addition to clause 41.4, it is unfair for any fielder wilfully to attempt, by word or action, to distract, deceive or obstruct either batter after the striker has received the ball.
- 41.5.2 It is for either one of the umpires to decide whether any distraction, deception or obstruction is wilful or not.
- 41.5.3 If either umpire considers that a fielder has caused or attempted to cause such a distraction, deception or obstruction, he/she shall immediately call and signal Dead ball and inform the other umpire of the reason for the call.
- 41.5.4 Neither batter shall be dismissed from that delivery.
- 41.5.5 If an obstruction involves physical contact, the umpires together shall decide whether or not an offence under clause 42 (Players' conduct) has been committed.
- 41.5.5.1 If an offence under clause 42 (Players' conduct) has been committed, they shall apply the relevant procedures in clause 42 and shall also apply each of clauses 41.5.7 to 41.5.9.
- 41.5.5.2 If they consider that there has been no offence under clause 42 (Players' conduct), they shall apply each of clauses 41.5.6 to 41.5.10.

- 41.5.6 The bowler's end umpire shall;
- award 5 Penalty runs to the batting side.
 - inform the captain of the fielding side of the reason for this action and as soon as practicable inform the captain of the batting side.
- 41.5.7 The ball shall not count as one of the over.
- 41.5.8 Any runs completed by the batters before the offence shall be scored, together with any runs for penalties awarded to either side. Additionally, the run in progress shall be scored whether or not the batters had already crossed at the instant of the offence.
- 41.5.9 The batters at the wicket shall decide which of them is to face the next delivery.
- 41.5.10 The umpires may then report the matter to the ICC Match Referee who shall take such action as is considered appropriate against the fielder concerned.

41.6 Bowling of dangerous and unfair short pitched deliveries

- 41.6.1 Notwithstanding clause 41.6.2, the bowling of short pitched deliveries is dangerous if the bowler's end umpire considers that, taking into consideration the skill of the striker, by their speed, length, height and direction they are likely to inflict physical injury on her. The fact that the striker is wearing protective equipment shall be disregarded.
- In the first instance the umpire decides that the bowling of short pitched deliveries has become dangerous under 41.6.1
- 41.6.1.1 The umpire shall call and signal No ball, and when the ball is dead, caution the bowler and inform the other umpire, the captain of the fielding side and the batters of what has occurred. This caution shall apply to that bowler throughout the innings.
- 41.6.1.2 If there is a second instance, the umpire shall repeat the above procedure and indicate to the bowler that this is a final warning, which shall apply to that bowler throughout the innings.
- 41.6.1.3 Should there be any further instance by the same bowler in that innings, the umpire shall
- call and signal No ball
 - when the ball is dead, direct the captain of the fielding side to suspend the bowler immediately from bowling
 - inform the other umpire for the reason for this action.
- The bowler thus suspended shall not be allowed to bowl again in that innings.

If applicable, the over shall be completed by another bowler, who shall neither have bowled any part of the previous over, nor be allowed to bowl any part of the next over.

- The umpire shall report the occurrence to the batters and, as soon as practicable, to the captain of the batting side.

The umpires may then report the matter to the ICC Match Referee who shall take such action as is considered appropriate against the bowler concerned.

- 41.6.1.4 A bowler shall be limited to one fast short-pitched deliveries per over.
- 41.6.1.5 A fast short-pitched delivery is defined as a ball, which passes or would have passed above the shoulder height of the striker standing upright at the popping crease.
- 41.6.1.6 The umpire at the bowler's end shall advise the bowler and the batter on strike when each fast short pitched delivery has been bowled.
- 41.6.1.7 In addition, a ball that passes above head height of the batter, standing upright at the popping crease, that prevents her from being able to hit it with her bat by means of a normal cricket stroke shall be called a Wide. See also clause 22.1.1.2
- 41.6.1.7.1 For the avoidance of doubt any fast short pitched delivery that is called a Wide under this playing condition shall also count as one of the allowable short pitched deliveries in that over.
- 41.6.1.8 In the event of a bowler bowling more than one fast short-pitched deliveries in an over as defined in clause 41.6.1.5 above, the umpire at the bowler's end shall call and signal No ball on each occasion. A differential signal shall be used to signify a fast short pitched delivery. The umpire shall call and signal 'No ball' and then tap the head with the other hand.
- 41.6.1.9 If a bowler delivers a second fast short pitched ball in an over, the umpire, after the call of No ball and when the ball is dead, shall caution the bowler, inform the other umpire, the captain of the fielding side and the batters at the wicket of what has occurred. This caution shall apply throughout the innings.
- 41.6.1.10 If there is a second instance of the bowler being No balled in the innings for bowling more than one fast short pitched deliveries in an over, the umpire shall advise the bowler that this is her final warning for the innings.

- 41.6.1.11 Should there be any further instance by the same bowler in that innings, the umpire shall
- call and signal No ball
 - when the ball is dead, direct the captain of the fielding side to suspend the bowler immediately from bowling
 - inform the other umpire for the reason for this action.
- The bowler thus suspended shall not be allowed to bowl again in that innings.
- If applicable, the over shall be completed by another bowler, who shall neither have bowled any part of the previous over, nor be allowed to bowl any part of the next over.
- The umpire shall report the occurrence to the batters and, as soon as practicable, to the captain of the batting side.
- The umpires may then report the matter to the ICC Match Referee who shall take such action as is considered appropriate against the bowler concerned.
- 41.6.2 Should the umpires initiate the caution and warning procedures set out in clauses 41.6.1.3 and 41.7 such cautions and warnings are not to be cumulative.

41.7 Bowling of dangerous and unfair non-pitching deliveries

- 41.7.1 Any delivery, which passes or would have passed, without pitching, above waist height of the striker standing upright at the popping crease, is to be deemed to be unfair, whether or not it is likely to inflict physical injury on the striker. If the bowler bowls such a delivery the umpire shall immediately call and signal No ball.
- If, in the opinion of the umpire, such a delivery is considered likely to inflict physical injury on the batter by its speed and direction, it shall be considered dangerous. When the ball is dead the umpire shall caution the bowler, indicating that this is a first and final warning. The umpire shall also inform the other umpire, the captain of the fielding side and the batters of what has occurred. This caution shall apply to that bowler throughout the innings.
- 41.7.2 Should there be any further instance (where a dangerous non-pitching delivery is bowled and is considered likely to inflict physical injury on the batter) by the same bowler in that innings, the umpire shall
- call and signal No ball
 - when the ball is dead, direct the captain of the fielding side to suspend the bowler immediately from bowling
 - inform the other umpire for the reason for this action.
- The bowler thus suspended shall not be allowed to bowl again in that innings.

If applicable, the over shall be completed by another bowler, who shall neither have bowled any part of the previous over, nor be allowed to bowl any part of the next over.

Additionally the umpire shall

- report the occurrence to the batters and, as soon as practicable, to the captain of the batting side.

The umpires may then report the matter to the ICC Match Referee who shall take such action as is considered appropriate against the bowler concerned.

41.7.3 The warning sequence in clauses 41.7.1 and 41.7.2 is independent of the warning and action sequence in clause 41.6.

41.7.4 If the umpire considers that a bowler deliberately bowled a high full-pitched delivery, deemed to be dangerous and unfair as defined in clause 41.7.1, then the caution and warning in clause 41.7.1 shall be dispensed with. The umpire shall

- immediately call and signal No ball.
- when the ball is dead, direct the captain of the fielding side to suspend the bowler immediately from bowling and inform the other umpire for the reason for this action.

The bowler thus suspended shall not be allowed to bowl again in that innings.

If applicable, the over shall be completed by another bowler, who shall neither have bowled any part of the previous over, nor be allowed to bowl any part of the next over.

- report the occurrence to the batters and, as soon as practicable, to the captain of the batting side.

The umpires together shall report the occurrence to the ICC Match Referee who shall take such action as is considered appropriate against the bowler concerned.

41.8 Bowling of deliberate front-foot No ball

If the umpire considers that the bowler has delivered a deliberate front-foot No ball, he/she shall

- immediately call and signal No ball.
- when the ball is dead, direct the captain of the fielding side to suspend the bowler immediately from bowling.
- inform the other umpire for the reason for this action.

The bowler thus suspended shall not be allowed to bowl again in that innings.

If applicable, the over shall be completed by another bowler, who shall neither have bowled any part of the previous over, nor be allowed to bowl any part of the next over.

- report the occurrence to the batters and, as soon as practicable, to the captain of the batting side.

The umpires together shall report the occurrence to the ICC Match Referee who shall take such action as is considered appropriate against the bowler concerned.

41.9 Time wasting by the fielding side

41.9.1 It is unfair for any fielder to waste time.

41.9.2 If either umpire considers that the progress of an over is unnecessarily slow, or time is being wasted in any other way, by the captain of the fielding side or by any other fielder, at the first instance the umpire concerned shall

- if the ball is in play, call and signal Dead ball.
- inform the other umpire of what has occurred.

The bowler's end umpire shall then

- warn the captain of the fielding side, indicating that this is a first and final warning.
- inform the batters of what has occurred.

41.9.3 If either umpire considers that there is any further waste of time in that innings by any fielder, the umpire concerned shall

- if the ball is in play, call and signal Dead ball.
- inform the other umpire of what has occurred.

The bowler's end umpire shall then award 5 Penalty runs to the batting side and inform the captain of the fielding side of the reason for this action.

Additionally the umpire shall inform the batters and, as soon as is practicable, the captain of the batting side of what has occurred.

If the umpires believe that the act of time wasting was deliberate or repetitive, they may lodge a report under the Code of Conduct. In such circumstances the Captain and/or any individual members of the fielding team responsible for the time wasting will be charged.

41.10 Batter wasting time

41.10.1 It is unfair for a batter to waste time. In normal circumstances, the striker should always be ready to take strike when the bowler is ready to start her run-up.

In addition, an incoming batter should be in position to take guard or her partner ready to receive the next ball within 2 minutes of the fall of the previous wicket.

41.10.2 Should either batter waste time by failing to meet this requirement, or in any other way, the following procedure shall be adopted. At the first instance, either before the bowler starts her run-up or when the ball becomes dead, as appropriate, the umpire shall

- warn both batters and indicate that this is a first and final warning. This warning shall apply throughout the innings. The umpire shall so inform each incoming batter.
- inform the other umpire of what has occurred.
- inform the captain of the fielding side and, as soon as practicable, the captain of the batting side of what has occurred.

- 41.10.3 If there is any further time wasting by any batter in that innings, the umpire shall, at the appropriate time while the ball is dead
- award 5 Penalty runs to the fielding side.
 - inform the other umpire of the reason for this action.
 - inform the other batter, the captain of the fielding side and, as soon as practicable, the captain of the batting side of what has occurred.

If the umpires believe that the act of time wasting was deemed to be deliberate or repetitive, they may lodge a report under the Code of Conduct. In such circumstances the batter concerned will be charged.

41.11 The protected area

The protected area is defined as that area of the pitch contained within a rectangle bounded at each end by imaginary lines parallel to the popping creases and 5 ft/1.52 m in front of each, and on the sides by imaginary lines, one each side of the imaginary line joining the centres of the two middle stumps, each parallel to it and 1 ft/30.48 cm from it.

41.12 Fielder damaging the pitch

- 41.12.1 It is unfair to cause deliberate or avoidable damage to the pitch. A fielder will be deemed to be causing avoidable damage if either umpire considers that her presence on the pitch is without reasonable cause.
- 41.12.2 If a fielder causes avoidable damage to the pitch, other than as in clause 41.13.1, at the first instance the umpire seeing the contravention shall, when the ball is dead, inform the other umpire. The bowler's end umpire shall then
- caution the captain of the fielding side and indicate that this is a first and final warning. This warning shall apply throughout the innings.
 - inform the batters of what has occurred.
- 41.12.3 If, in that innings, there is any further instance of avoidable damage to the pitch, by any fielder, the umpire seeing the contravention shall, when the ball is dead, inform the other umpire. The bowler's end umpire shall then
- award 5 Penalty runs to the batting side.
- Additionally the umpire shall
- inform the fielding captain of the reason for this action.
 - inform the batters and, as soon as practicable, the captain of the batting side of what has occurred.

The umpires together shall report the occurrence to the ICC Match Referee who shall take such action as is considered appropriate against the fielder concerned.

41.13 Bowler running on protected area

- 41.13.1 It is unfair for a bowler to enter the protected area in her follow-through without reasonable cause, whether or not the ball is delivered.
- 41.13.2 If a bowler contravenes this clause, at the first instance and when the ball is dead, the umpire shall
- caution the bowler and inform the other umpire of what has occurred. This caution shall apply to that bowler throughout the innings.
 - inform the captain of the fielding side and the batters of what has occurred.
- 41.13.3 If, in that innings, the same bowler again contravenes this clause, the umpire shall repeat the above procedure indicating that this is a final warning. This warning shall also apply throughout the innings.
- 41.13.4 If, in that innings, the same bowler contravenes this clause a third time, when the ball is dead, the umpire shall,
- direct the captain of the fielding side to suspend the bowler immediately from bowling. If applicable, the over shall be completed by another bowler, who shall neither have bowled any part of the previous over, nor be allowed to bowl any part of the next over. The bowler taken off shall not be allowed to bowl again in that innings.
 - inform the other umpire of the reason for this action.
 - inform the batters and, as soon as practicable, the captain of the batting side of what has occurred.

The umpires may then report the matter to the ICC Match Referee who shall take such action as is considered appropriate against the bowler concerned.

41.14 Batter damaging the pitch

- 41.14.1 It is unfair to cause deliberate or avoidable damage to the pitch. If the striker enters the protected area in playing or playing at the ball, she must move from it immediately thereafter. A batter will be deemed to be causing avoidable damage if either umpire considers that her presence on the pitch is without reasonable cause.
- 41.14.2 If either batter causes deliberate or avoidable damage to the pitch, other than as in clause 41.15, at the first instance the umpire seeing the contravention shall, when the ball is dead, inform the other umpire of the occurrence. The bowler's end umpire shall then
- warn both batters that the practice is unfair and indicate that this is a first and final warning. This warning shall apply throughout the innings. The umpire shall so inform each incoming batter.
 - inform the captain of the fielding side and, as soon as practicable, the captain of the batting side of what has occurred.

- 41.14.3 If there is any further instance of avoidable damage to the pitch by any batter in that innings, the umpire seeing the contravention shall, when the ball is dead, inform the other umpire of the occurrence.

The bowler's end umpire shall

- disallow all runs to the batting side.
- return any not out batter to her original end.
- signal No ball or Wide to the scorers if applicable.
- award 5 Penalty runs to the fielding side.
- award any other 5-run Penalty that is applicable except for Penalty runs under clause 28.3 (Protective helmets belonging to the fielding side).
- Inform the captain of the fielding side and, as soon as practicable, the captain of the batting side of the reason for this action.

The umpires together shall report the occurrence to the ICC Match Referee who shall take such action as is considered appropriate against the batter concerned.

41.15 Striker in protected area

- 41.15.1 The striker shall not adopt a stance in the protected area or so close to it that frequent encroachment is inevitable.

The striker may mark a guard on the pitch provided that no mark is unreasonably close to the protected area.

- 41.15.2 If either umpire considers that the striker is in breach of any of the conditions in clause 41.15.1, if the bowler has not entered the delivery stride, he/she shall immediately call Dead ball, otherwise, wait until the ball is dead; he/she shall then inform the other umpire of the occurrence.

The bowler's end umpire shall then

- warn the striker that the practice is unfair and indicate that this is a first and final warning. This warning shall apply throughout the innings. The umpire shall so inform the non-striker and each incoming batter.
- inform the captain of the fielding side and, as soon as practicable, the captain of the batting side of what has occurred.

- 41.15.3 If there is any further breach of any of the conditions in clause 41.15.1 by any batter in that innings, the umpire seeing the contravention shall, if the bowler has not entered her delivery stride, immediately call and signal Dead ball, otherwise, he/she shall wait until the ball is dead and then inform the other umpire of the occurrence.

The bowler's end umpire shall

- disallow all runs to the batting side.
- return any not out batter to her original end.
- signal No ball or Wide to the scorers if applicable.
- award 5 Penalty runs to the fielding side.
- award any other 5-run Penalty that is applicable except for Penalty runs under clause 28.3 (Protective helmets belonging to the fielding side).
- inform the captain of the fielding side and, as soon as practicable, the captain of the batting side of the reason for this action.

The umpires together shall report the occurrence to the ICC Match Referee who shall take such action as is considered appropriate against the batter concerned.

41.16 Non-striker leaving her ground early

If the non-striker is out of her ground from the moment the ball comes into play to the instant when the bowler would normally have been expected to release the ball, the bowler is permitted to attempt to run her out. Whether the attempt is successful or not, the ball shall not count as one in the over.

If the bowler fails in an attempt to run out the non-striker, the umpire shall call and signal Dead ball as soon as possible.

41.17 Batters stealing a run

- 41.17.1 It is unfair for the batters to attempt to steal a run during the bowler's run-up.

Unless the bowler attempts to run out either batter – see clauses 41.16 and 21.4 (Bowler throwing towards striker's end before delivery) – the umpire shall

- call and signal Dead ball as soon as the batters cross in such an attempt.
- inform the other umpire of the reason for this action.

The bowler's end umpire shall then

- return the batters to their original ends.
- award 5 Penalty runs to the fielding side.
- inform the batters, the captain of the fielding side and, as soon as practicable, the captain of the batting side, of the reason for this action.

The umpires may then report the matter to the ICC Match Referee who shall take such action as is considered appropriate against the batter concerned.

41.18 Penalty runs

- 41.18.1 When Penalty runs are awarded to either side, when the ball is dead the umpire shall signal the Penalty runs to the scorers. See clause 2.13 (Signals).
- 41.18.2 Penalty runs shall be awarded in each case where these Playing Conditions require the award, even if a result has already been achieved. See clause 16.6 (Winning hit or extras).
- Note, however, that the restrictions on awarding Penalty runs, in clauses 23.3 (Leg byes not to be awarded), 34.4 (Runs scored from ball lawfully struck more than once) and 28.3 (Protective helmets belonging to the fielding side), will apply.
- 41.18.3 When 5 Penalty runs are awarded to the batting side under any of clauses 24.4 (Player returning without permission), 28.2 (Fielding the ball), 28.3 (Protective helmets belonging to the fielding side) or under 41.3, 41.4, 41.5, 41.9 or 41.12, then
- they shall be scored as Penalty extras and shall be in addition to any other penalties.
 - they are awarded when the ball is dead and shall not be regarded as runs scored from either the immediately preceding delivery or the immediately following delivery, and shall be in addition to any runs from those deliveries.
 - the batters shall not change ends solely by reason of the 5 run penalty.
- 41.18.4 When 5 Penalty runs are awarded to the fielding side, under clause 18.5.2 (Deliberate short runs), or under 41.10, 41.14, 41.15 or 41.17, they shall be added as Penalty extras to that side's total of runs in its most recently completed innings. If the fielding side has not completed an innings, the 5 Penalty runs shall be added to the score in its next innings.

42 PLAYERS' CONDUCT**42.1 Serious misconduct**

- 42.1.1 The umpires shall act upon any serious misconduct. The relevant offences and the corresponding actions by the umpires are identified in clause 42.2.1. These offences correspond with Level 4 offences in the ICC Code of Conduct. Level 1 to Level 3 offences continue to be dealt with separately under the ICC Code of Conduct.
- 42.1.2 If either umpire considers that a player has committed one of these offences at any time during the match, the umpire concerned shall call and signal Dead ball. This call may be delayed until the umpire is satisfied that it will not disadvantage the non-offending side.
- 42.1.3 The umpire concerned shall report the matter to the other umpire and together they shall decide whether an offence has been committed. The umpires may also consult with the third umpire and the match referee, who may review any audio or video replays to confirm whether an offence has been committed. If so, the umpires shall then apply the related sanctions.

- 42.1.4 If the offence is committed by a batter, the umpires shall summon the offending player's captain to the field. Solely for the purpose of this clause, the batters at the wicket may not deputise for their captain.

42.2 Level 4 offences and action by umpires

- 42.2.1 Any of the following actions by a player shall constitute a Level 4 offence:
- threatening to assault an umpire
 - making inappropriate and deliberate physical contact with an umpire
 - physically assaulting a player or any other person
 - committing any other act of violence.
- 42.2.2 If such an offence is committed, 42.2.2.1 to 42.2.2.5 shall be implemented.
- 42.2.2.1 The umpire shall call Time.
- 42.2.2.2 Together the umpires shall summon and inform the offending player's captain that an offence at this Level has occurred.
- 42.2.2.3 The umpires shall instruct the captain to remove the offending player immediately from the field of play for the remainder of the match and shall apply the following:
- 42.2.2.3.1 If the offending player is a fielder, no substitute shall be allowed for her. She is to be recorded as Retired – out at the commencement of any subsequent innings in which her team is the batting side.
- 42.2.2.3.2 If a bowler is suspended mid-over, then that over must be completed by a different bowler, who shall not have bowled the previous over nor shall be permitted to bowl the next over.
- 42.2.2.3.3 If the offending player is a batter she is to be recorded as Retired – out in the current innings, unless she has been dismissed under any of clauses 32 to 39, and at the commencement of any subsequent innings in which her team is the batting side. If no further batter is available to bat, the innings is completed.
- 42.2.2.4 As soon as practicable, the umpire shall:
- award 5 Penalty runs to the opposing team
 - signal the Level 4 penalty to the scorers
 - call Play.
- 42.2.2.5 The umpires shall then report the matter to the ICC Match Referee under the ICC Code of Conduct.

42.3 Captain refusing to remove a player from the field

- 42.3.1 If a captain refuses to carry out an instruction under 42.2.2.3, the umpires shall invoke clause 16.2 (ICC Match Referee awarding a match).
- 42.3.2 If both captains refuse to carry out instructions under 42.2.2.3 in respect of the same incident, the umpires shall instruct the players to leave the field. The match is not concluded as in clause 12.6 and there shall be no result under clause 16.

42.4 Additional points relating to Level 4 offences

- 42.4.1 If a player, while acting as wicket-keeper, commits a Level 4 offence, clause 24.1.2 shall not apply, meaning that only a nominated player may keep wicket, even if another fielder becomes injured or ill and is replaced by a substitute.
- 42.4.2 A nominated player who has a substitute will also suffer the penalty for any Level 4 offence committed by the substitute. However, only the substitute will be reported under clause 42.2.2.5.

APPENDICES TO ICC WOMEN'S TWENTY20 INTERNATIONAL MATCH PLAYING CONDITIONS

(INCORPORATING THE 2017 CODE OF THE MCC LAWS OF CRICKET)

A. Definitions**B. Equipment**

1. The bat
2. The wickets
3. Wicket-keeping gloves

C. The venue

1. The pitch and the creases
2. Advertising on grounds, perimeter boards and sight-screens
3. Markings on outfield

D. Decision Review System (DRS) and Third Umpire Protocol**E. Calculations****F. The Super Over**

APPENDIX A

DEFINITIONS

1 THE MATCH

- 1.1 **The game** is used in these Playing Conditions as a general term meaning the Game of Cricket.
- 1.2 **A Green status Member** for the purpose of these playing conditions is an ICC Member whose women's team does not have ODI status. Refer to the changes to the playing conditions for T20I matches played between Green status Members on page 1 of these playing conditions.
- 1.3 **A match** is a single Twenty20 International between two teams, played under these Playing Conditions.
- 1.4 **T20I** is an abbreviation for Twenty20 International.
- 1.5 **A Super Over** is a procedure that may be adopted for determining the result of a tied match, as set out in Appendix F.
- 1.6 **The toss** is the toss for choice of innings.
- 1.7 **Before the toss** is at any time before the toss on the day the match is expected to start.
- 1.8 **Before the match** is at any time before the toss, not restricted to the day of the match.
- 1.9 **During the match** is at any time after the toss until the conclusion of the match, whether play is in progress or not.
- 1.10 **Playing time** is any time between the call of Play and the call of Time. See clauses 12.1 (Call of Play) and 12.2 (Call of Time).
- 1.11 **Conduct of the match** includes any action relevant to the match at any time.
- 1.12 **Ground Authority** is the entity responsible for the selection and preparation of the pitch and other functions relating to the hosting and management of the match, including any agents acting on their behalf (including but not limited to the curator or other ground staff).
- 1.13 **Home Board** is the ICC member responsible for the home team and the hosting of the match.
- 1.14 **Visiting Board** is the ICC member responsible for the visiting team.
- 1.15 **The Spirit of Cricket** refers to the values of respect and fair play that underpin the game of cricket, as set out in the Preamble to these Playing Conditions.
- 1.16 **The ICC Code of Conduct** is the ICC Code of Conduct for Players and Player Support Personnel, as amended from time to time.

2 IMPLEMENTS AND EQUIPMENT

- 2.1 **Implements used** in the match are the bat, the ball, the stumps and balls.
- 2.2 **External protective equipment** is any visible item of apparel worn for protection against external blows.
For a batter, items permitted are a protective helmet, external leg guards (batting pads), batting gloves and, if visible, forearm guards.

For a fielder, only a protective helmet is permitted, except in the case of a wicket-keeper, for whom wicket-keeping pads and gloves are also permitted.

- 2.3 **A protective helmet** is headwear made of hard material and designed to protect the head or the face or both, which shall (in line with the Clothing and Equipment Regulations) be certified to BS7928:2013. For the purposes of interpreting these Playing Conditions, such a description will include faceguards.
- 2.4 **Equipment** – a batter's equipment is her bat as defined above, together with any external protective equipment she is wearing.
A fielder's equipment is any external protective equipment that she is wearing.
- 2.5 **The bat** – the following are to be considered as part of the bat:
 - the whole of the bat itself.
 - the whole of a glove (or gloves) worn on the hand (or hands) holding the bat.
 - the hand (or hands) holding the bat, if the batter is not wearing a glove on that hand or on those hands.
- 2.6 **Held in batter's hand.** Contact between a batter's hand, or glove worn on her hand, and any part of the bat shall constitute the bat being held in that hand.

3 THE PLAYING AREA

- 3.1 **The field of play** is the area contained within the boundary.
- 3.2 **The square** is a specially prepared area of the field of play within which the match pitch is situated.
- 3.3 **The outfield** is that part of the field of play between the square and the boundary.

4 POSITIONING

- 4.1 **Behind the popping crease at one end of the pitch** is that area of the field of play, including any other marking, objects and persons therein, that is on that side of the popping crease that does not include the creases at the opposite end of the pitch. Behind, in relation to any other marking, object or person, follows the same principle. See the diagram in paragraph 13.
- 4.2 **In front of the popping crease at one end of the pitch** is that area of the field of play, including any other marking, objects and persons therein, that is on that side of the popping crease that includes the creases at the opposite end of the pitch. In front of, in relation to any other marking, object or person, follows the same principle. See the diagram in paragraph 13.
- 4.3 **The striker's end** is the place where the striker stands to receive a delivery from the bowler only insofar as it identifies, independently of where the striker may subsequently move, one end of the pitch.
- 4.4 **The bowler's end** is the end from which the bowler delivers the ball. It is the other end of the pitch from the striker's end and identifies that end of the pitch that is not the striker's end as described in paragraph 4.3.
- 4.5 **The wicket-keeper's end** is the same as the striker's end as described in paragraph 4.3.

- 4.6 **In front of the line of the striker's wicket** is in the area of the field of play in front of the imaginary line joining the fronts of the stumps at the striker's end; this line to be considered extended in both directions to the boundary. See paragraph 4.2.
- 4.7 **Behind the wicket** is in the area of the field of play behind the imaginary line joining the backs of the stumps at the appropriate end; this line to be considered extended in both directions to the boundary. See paragraph 4.1.
- 4.8 **Behind the wicket-keeper** is behind the wicket at the striker's end, as defined above, but in line with both sets of stumps and further from the stumps than the wicket-keeper.
- 4.9 **Off side/on (leg) side** – see diagram in paragraph 13.
- 4.10 **Inside edge** is the edge on the same side as the nearer wicket.

5 UMPIRES AND DECISION-MAKING

- 5.1 **Umpire** – where the description **the umpire** is used on its own, it always means 'the bowler's end umpire' though this full description is sometimes used for emphasis or clarity. Similarly the umpires always means both umpires and the third umpire. **An umpire** and umpires are generalised terms. Otherwise, a fuller description indicates which one of the umpires is specifically intended. Each umpire will be bowler's end umpire and striker's end umpire in alternate overs.
- 5.2 **Bowler's end umpire** is the umpire who is standing at the bowler's end (see paragraph 4.4) for the current delivery.
- 5.3 **Striker's end umpire** is the umpire who is standing at the striker's end (see paragraph 4.3), to one side of the pitch or the other, depending on his/her choice, for the current delivery.
- 5.4 **On-field umpires** shall mean, collectively, the bowler's end umpire and the striker's end umpire.
- 5.5 **Third umpire** is the umpire who may use television evidence and other available technology in order review a decision of the on-field umpires, either by way of an Umpire Review or a Player Review under the protocol set out in Appendix D.
- 5.6 **Umpires together agree** applies to decisions which the umpires are to make jointly, independently of the players.
- 5.7 **Decision Review System** or **DRS** is the process covered by the Decision Review System and Third Umpire Protocol set out in Appendix D, under which the third umpire may be consulted in relation to a decision of the on-field umpires, either by way of an Umpire Review or a Player Review.
- 5.8 **Player Review** is the process set out in Appendix D by which a player may request a review of any decision taken by the on-field umpires concerning whether or not a batter is dismissed (with the exception of 'Timed out').
- 5.9 **Umpire Review** is the process set out in Appendix D by which an on-field umpire has the discretion to refer a decision to the third umpire or, under certain circumstances, to consult with the third umpire before making a decision.
- 5.10 **Soft Signal** is the visual communication by the bowler's end umpire to the third umpire (accompanied by additional information via two-way radio where necessary) of his/her initial on-field decision prior to initiating an Umpire Review.
- 5.11 **Umpire's Call** is the concept within the DRS under which the on-field decision of the bowler's end umpire shall stand, which shall apply under the specific circumstances set out in paragraphs 3.4.5 and 3.4.6 of Appendix D, where the ball-tracking technology indicates a marginal decision in respect of either the Impact Zone or the Wicket Zone.
- 5.12 The **Pitching Zone** as used in the DRS is a two dimensional area on the pitch between both sets of stumps with its boundaries consisting of the base of both sets of stumps and a line between the outside of the outer stumps at each end.
- 5.13 The **Impact Zone** as used in the DRS is a three dimensional space extending between both sets of stumps to an indefinite height vertically and with its boundaries consisting of the base of the stumps and the outside of the outer stumps at each end.
- 5.14 The **Wicket Zone** as used in the DRS is a two dimensional area with its boundaries consisting of the outside of the outer stumps, the base of the stumps, and the lower edge of the bails.
- 5.15 A **Fair Catch** is a catch that has been taken cleanly by the fielder in accordance with clause 33.
- 5.16 A **Bump Ball** is where the ball has made contact with the ground shortly after making contact with the striker's bat.
- 5.17 The **Elite Panel** is the group of umpires contracted to the ICC to officiate in international cricket.
- 5.18 The **International Panel** is the group of umpires nominated by the ICC's full members in accordance with clause 2.1.3 of the Playing Conditions.
- 5.19 The **First-Class Panel** is the group of umpires nominated by the ICC's full members in accordance with clause 2.1.3 of the Playing Conditions.
- 5.20 The **ICC Development Panel** is the group of umpires nominated by the ICC's full and associate members in accordance with clause 2.1.3 of the Playing Conditions.
- 5.21 The **International Panel of Referees** is the group of referees nominated by the ICC's full members in accordance with clause 2.1.6 of the Playing Conditions.

6 BATTERS

- 6.1 **Batting side** is the side currently batting, whether or not play is in progress.
- 6.2 **Member of the batting side** is one of the players nominated by the captain of the batting side, or any authorised replacement for such nominated player.
- 6.3 A **batter's ground** – at each end of the pitch, the whole area of the field of play behind the popping crease is the ground at that end for a batter.
- 6.4 **Original end** is the end where a batter was when the ball came into play for that delivery.
- 6.5 **Wicket she has left** is the wicket at the end where a batter was at the start of the run in progress.
- 6.6 **Guard position** is the position and posture adopted by the striker to receive a ball delivered by the bowler.
- 6.7 For the purposes of these Playing Conditions, waist height is defined as the point at which the top of the batter's trousers would conventionally be when she is standing upright at the popping crease.

7 FIELDERS

- 7.1 Fielding side** is the side currently fielding, whether or not play is in progress.
- 7.2 Member of the fielding side** is one of the players nominated by the captain of the fielding side, or any authorised replacement or substitute for such nominated player.
- 7.3 Fielder** is one of the 11 or fewer players who together represent the fielding side on the field of play. This definition includes not only both the bowler and the wicket-keeper but also nominated players who are legitimately on the field of play, together with players legitimately acting as substitutes for absent nominated players. It excludes any nominated player who is absent from the field of play, or who has been absent from the field of play and who has not yet obtained the umpire's permission to return.

A player going briefly outside the boundary in the course of discharging her duties as a fielder is not absent from the field of play nor, for the purposes of clause 24.2 (Fielder absent or leaving the field of play), is she to be regarded as having left the field of play.

8 SUBSTITUTES AND CONCUSSION REPLACEMENTS

- 8.1 A Substitute** is a player who takes the place of a fielder on the field of play, but does not replace the player for whom she substitutes on that side's list of nominated players. A substitute's activities are limited to fielding.
- 8.2 A Concussion Replacement** is a player who takes the place of a player who has been replaced in accordance with the process set out in clause 12.7, and who for the remainder of the match replaces that player on that side's list of nominated players, being able to take a full part in the match (subject to such restrictions as may be imposed by the ICC Match Referee in accordance with clause 12.8)
- 8.3 A Concussion Replacement Request** is the notification made to the ICC Match Referee in accordance with the process set out in clause 12.7.3
- 8.4 The Team Medical Representative** is the individual designated as having responsibility for the assessment of any head or neck injury sustained by a player as set out in clause 12.7.2.

9 BOWLERS

- 9.1 Over the wicket/round the wicket** – If, as the bowler runs up between the wicket and the return crease, the wicket is on the same side as her bowling arm, she is bowling over the wicket. If the return crease is on the same side as her bowling arm, she is bowling round the wicket.
- 9.2 Delivery swing** is the motion of the bowler's arm during which she normally releases the ball for a delivery.
- 9.3 Delivery stride** is the stride during which the delivery swing is made, whether the ball is released or not. It starts when the bowler's back foot lands for that stride and ends when the front foot lands in the same stride. The stride after the delivery stride is completed when the next foot lands, i.e. when the back foot of the delivery stride lands again.
- 9.4 The Illegal Bowling Regulations** are the ICC's regulations governing Illegal Bowling Actions.
- 9.5 An Illegal Bowling Action** is a bowling action where a bowler's Elbow Extension exceeds 15 degrees, measured from the point at which the bowling arm reaches the horizontal until the point at which the ball

is released (any Elbow Hyperextension shall be discounted for the purposes of determining an Illegal Bowling Action).

- 9.6 Elbow Extension** means the motion that occurs when a bowler's arm moves from a flexed (bent) position at the elbow, to a more extended (straight) position (full Elbow Extension occurs when the arm is straight).
- 9.7 Elbow Hyperextension** is the motion that occurs when a bowler's elbow extends beyond the straight position.
- 9.8 The ICC Bowling Action Report Form** is the form provided for by Article 3 of the Illegal Bowling Regulations, by which an umpire and/or the ICC Match Referee may submit a report relating to a suspected Illegal Bowling Action.

10 THE BALL

- 10.1 The ball** is struck/strikes the ball unless specifically defined otherwise, mean 'the ball is struck by the bat'/'strikes the ball with the bat'.
- 10.2 Rebounds directly/strikes directly and similar phrases** mean 'without contact with any fielder' but do not exclude contact with the ground.
- 10.3 Full-pitch** describes a ball delivered by the bowler that reaches or passes the striker without having touched the ground. Sometimes described as non-pitching.

11 RUNS

- 11.1 A run to be disallowed** is one that in these Playing Conditions should not have been taken. It is not only to be cancelled but the batters are to be returned to their original ends.
- 11.2 A run not to be scored** is one that is not illegal, but is not recognised as a properly executed run. It is not a run that has been made, so the question of cancellation does not arise. The loss of the run so attempted is not a disallowance and the batters will not be returned to their original ends on that account.

12 THE PERSON

- 12.1 Person;** A player's person is her physical person (flesh and blood) together with any clothing or legitimate external protective equipment that she is wearing except, in the case of a batter, her bat.
- A hand, whether gloved or not, that is not holding the bat is part of the batter's person.
- No item of clothing or equipment is part of the player's person unless it is attached to her.
- For a batter, a glove being held but not worn is part of her person.
- For a fielder, an item of clothing or equipment she is holding in her hand or hands is not part of her person.
- 12.2 Clothing** – anything that a player is wearing, including such items as spectacles or jewellery, that is not classed as external protective equipment is classed as clothing, even though she may be wearing some items of apparel, which are not visible, for protection. A bat being carried by a batter does not come within this definition of clothing.
- 12.3 Hand for batter or wicket-keeper** shall include both the hand itself and the whole of a glove worn on the hand.

13 OFF SIDE/ON SIDE; IN FRONT OF/ BEHIND THE POPPING CREASE

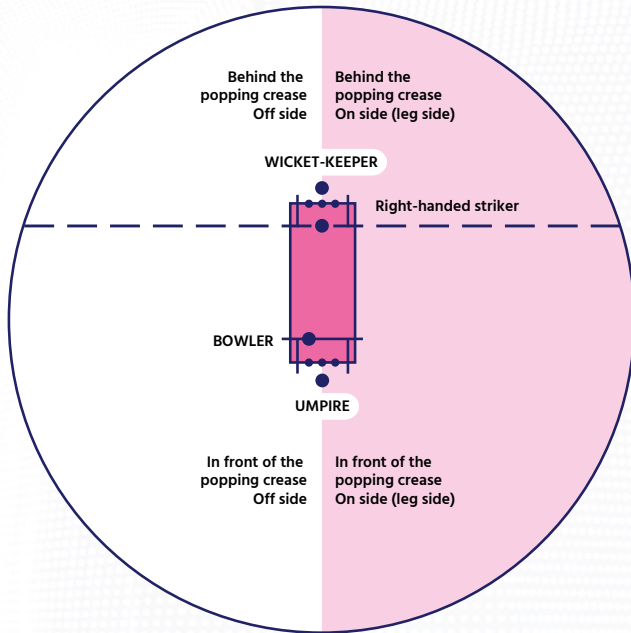

APPENDIX B

EQUIPMENT

1 THE BAT

1.1 General guidance

- 1.1.1 Measurements – All provisions in paragraphs 1.2 to 1.6 below are subject to the measurements and restrictions stated in the Playing Conditions and this Appendix.
- 1.1.2 Adhesives – Throughout, adhesives are permitted only where essential and only in minimal quantity.

1.2 Specifications for the Handle

- 1.2.1 One end of the handle is inserted into a recess in the blade as a means of joining the handle and the blade.

This lower portion is used purely for joining the blade and the handle together. It is not part of the blade but, solely in interpreting paragraphs 1.3 and 1.4 below, references to the blade shall be considered to extend also to this lower portion of the handle where relevant.

- 1.2.2 The handle may be glued where necessary and bound with twine along the upper portion.

Providing clause 5.5 is not contravened, the upper portion may be covered with materials solely to provide a surface suitable for gripping. Such covering is an addition and is not part of the bat, except in relation to clause 5.6. The bottom of this grip should not extend below the point defined in paragraph 1.2.4 below.

Twine binding and the covering grip may extend beyond the junction of the upper and lower portions of the handle, to cover part of the shoulders of the bat as defined in paragraph 1.3.1.

No material may be placed on or inserted into the lower portion of the handle other than as permitted above together with the minimal adhesives or adhesive tape used solely for fixing these items, or for fixing the handle to the blade.

- 1.2.3 Materials in handle – As a proportion of the total volume of the handle, materials other than cane, wood or twine are restricted to one-tenth. Such materials must not project more than 3.25 in/8.26 cm into the lower portion of the handle.
- 1.2.4 Binding and covering of handle – The permitted continuation beyond the junction of the upper and lower portions of the handle is restricted to a maximum, measured along the length of the handle, of
- 2.5 in/6.35 cm in for the twine binding.
 - 2.75 in/6.99 cm for the covering grip.

1.3 Specifications for the Blade

- 1.3.1 The blade has a face, a back, a toe, sides and shoulders
- 1.3.1.1 The face of the blade is its main striking surface and shall be flat or have a slight convex curve resulting from traditional pressing techniques. The back is the opposite surface.
- 1.3.1.2 The shoulders, sides and toe are the remaining surfaces, separating the face and the back.
- 1.3.1.3 The shoulders, one on each side of the handle, are along that portion of the blade between the first entry point of the handle and the point at which the blade first reaches its full width.
- 1.3.1.4 The toe is the surface opposite to the shoulders taken as a pair.
- 1.3.1.5 The sides, one each side of the blade, are along the rest of the blade, between the toe and the shoulders.
- 1.3.2 No material may be placed on or inserted into the blade other than as permitted in paragraph 1.2.4, paragraph 1.3.3, and clause 5.4 together with the minimal adhesives or adhesive tape used solely for fixing these items, or for fixing the handle to the blade.
- 1.3.3 Covering the blade. Bats shall have no covering on the blade except as permitted in clause 5.4.
- Any materials referred to above, in clause 5.4 and paragraph 1.4 below, are to be considered as part of the bat, which must still pass through the gauge as defined in paragraph 1.6.

1.4 Protection and repair

- 1.4.1 The surface of the blade may be treated with non-solid materials to improve resistance to moisture penetration and/or mask natural blemishes in the appearance of the wood. Save for the purpose of giving a homogeneous appearance by masking natural blemishes, such treatment shall not materially alter the colour of the blade.
- 1.4.2 Materials can be used for protection and repair as stated in clause 5.4 and are additional to the blade. Note however clause 5.6.
- Any such material shall not extend over any part of the back of the blade except in the case of clause 5.4.1 and then only when it is applied as a continuous wrapping covering the damaged area.
- The repair material shall not extend along the length of the blade more than 0.79 in/2.0 cm in each direction beyond the limits of the damaged area. Where used as a continuous binding, any overlapping shall not breach the maximum of 0.04 in/0.1 cm in total thickness.
- The use of non-solid material which when dry forms a hard layer more than 0.004 in/0.01 cm in thickness is not permitted.
- 1.4.3 Permitted coverings, repair material and toe guards, not exceeding their specified thicknesses, may be additional to the dimensions above, but the bat must still pass through the gauge as described in paragraph 1.6.

1.5 Commercial identifications

Such identifications shall comply with the restrictions set out in the Clothing and Equipment Regulations in relation to the size and position of marks and logos.

1.6 Bat Gauge

All bats must meet the specifications defined in clause 5.7. They must also, with or without protective coverings permitted in clause 5.4, be able to pass through a bat gauge, the dimensions and shape of which are shown in the following diagram:

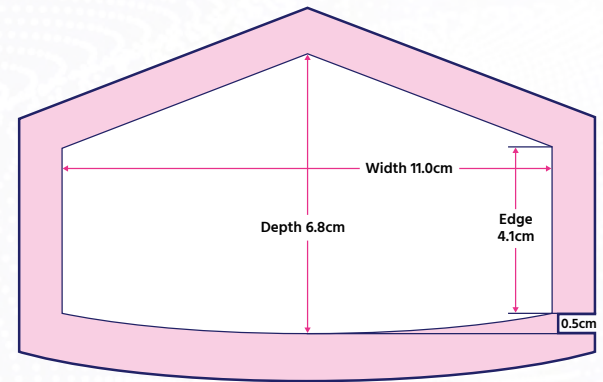

DIMENSIONS OF APERTURE

Total Depth: 2.68 in/6.8 cm

Width: 4.33 in/11.0 cm

Edge: 1.61 in/4.1 cm

Curve: 0.20 in/0.5 cm

Note: The curve of the lower edge of the aperture is an arc of a circle of radius 12.0 in/30.5 cm, whose centre is on the vertical centre line of the aperture.

2 THE WICKETS**2.1 Bails**

Overall 4.31 in/10.95 cm

a = 1.38 in/3.50 cm

b = 2.13 in/5.40 cm

c = 0.81 in/2.06 cm

2.2 Stumps

Height (d) = 28 in/71.1 cm

Diameter (e) - maximum = 1.5 in/3.81 cm; minimum = 1.38 in/3.50 cm

2.3 Overall

Width (f) of wicket 9 in/22.86 cm

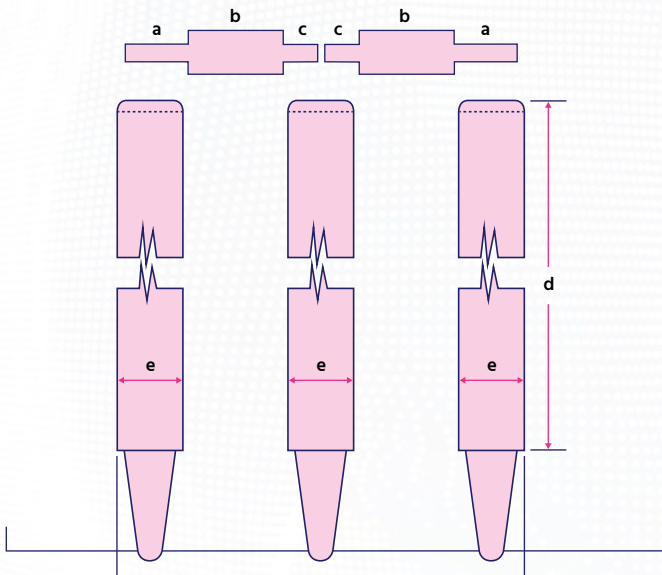
**3 WICKET-KEEPING GLOVES**

3.1 The images below illustrate the requirements of clause 27.2 in relation to:

- no webbing between the fingers;
- a single piece of non-stretch material between finger and thumb as a means of support; and
- when a hand wearing the glove has the thumb fully extended, the top edge being taut and not protruding beyond the straight line joining the top of the index finger to the top of the thumb.

3.2 Note also the requirement for wicket-keeping gloves to comply with the Clothing and Equipment Regulations in relation to the size and position of marks and logos.

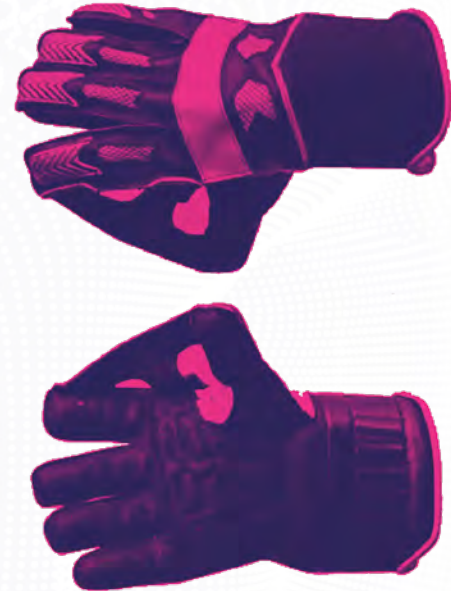

APPENDIX C

THE VENUE

1 THE PITCH AND THE CREASES



2 RESTRICTION ON THE PLACEMENT OF FIELDERS

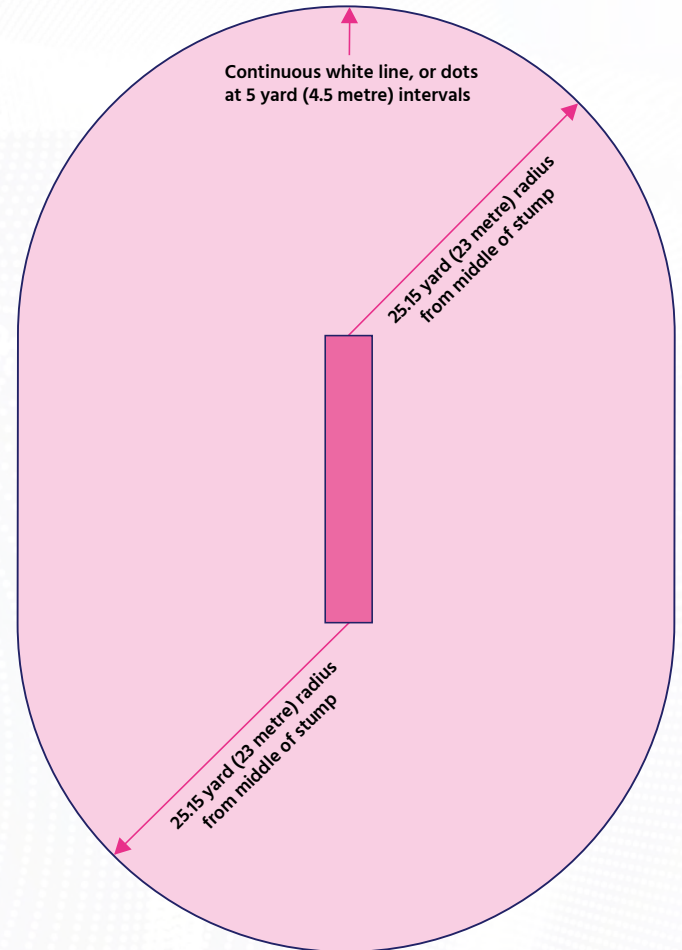

3 ADVERTISING ON GROUNDS, PERIMETER BOARDS AND SIGHT-SCREENS

3.1 Advertising on grounds

- 3.1.1 The logos on outfielders are to be positioned as follows:
- Behind the stumps – a minimum of 25.15 yards (23 meters) from the stumps.
 - Midwicket/cover area – no advertising to be positioned within 30 yards (27.50 meters) of the centre of the pitch being used for the match.
- 3.1.2 Note: Advertising closer to the stumps as set out above which is required to meet 3D requirements for broadcasters may be permitted, subject to prior ICC approval having been obtained.

3.2 Perimeter boards

- 3.2.1 Advertising on perimeter boards placed in front of the sight-screens is permitted save that the predominant colour of such advertising shall be of a contrasting colour to that of the ball.
- 3.2.2 Advertising on perimeter boards behind the stumps at both ends shall not contain moving, flashing or flickering images and operators should ensure that the images are only changed or moved at a time that will not be distracting to the players or the umpires.
- 3.2.3 The brightness of any electronic images shall be set at a level so that it is not a distraction to the players or umpires.

3.3 Sight-screens

- 3.3.1 Sight-screens shall be provided at both ends of all grounds.
- 3.3.2 Advertising shall be permitted on the sight-screen behind the striker, providing it is removed for the subsequent over from that end.
- 3.3.3 Such advertising shall not contain flashing or flickering images and particular care should be taken by the operators that the advertising is not changed at a time which is distracting to the umpire.

4 MARKINGS ON OUTFIELD

With the permission of the Ground Authority, a bowler may use paint to make a small marking on the outfield for the purposes of identifying their run-up. Paint used for this purpose shall be any colour other than white.

APPENDIX D

DECISION REVIEW SYSTEM (DRS) AND THIRD UMPIRE PROTOCOL

1 GENERAL

1.1 Minimum requirements for use of DRS and appointment of third umpire

- 1.1.1 The Home Board shall endeavor to broadcast all T20I Matches played in its country.
- 1.1.2 Where matches are broadcast, the camera specification set out below shall be mandatory as a minimum requirement.

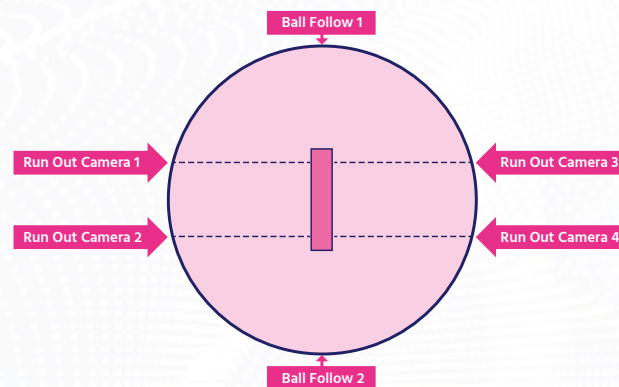

- 1.1.3 Where the camera specification set out above is provided, a third umpire shall be appointed to the match.
- 1.1.4 If the minimum requirements for DRS to be used are satisfied, both participating Boards may agree to employ the DRS for a T20I match. Otherwise, the third umpire shall be appointed and empowered to use broadcast replays to make decisions that are referred to him/her in accordance with paragraph 2 (Umpire Reviews).

- 1.1.5 The table below summarises the minimum requirements for DRS to be used, and the recommended regulations around the appointment of the third umpire:

	THIRD UMPIRE (NON-DRS)	DRS
Minimum Requirement	Cameras Specification detailed in paragraph 1.1.2.	Cameras <ul style="list-style-type: none"> - Specification detailed in paragraph 1.1.2. Technology. - Approved ball-tracking technology. - Approved sound-based edge detection technology.
Third Umpire Appointment	Appointed by Home Board from the ICC Elite Panel, International Panel or First Class Panel of umpires.	Appointed by the Home Board from the ICC Elite Panel or International Panel of umpires.
Third Umpire Jurisdiction	Umpire Reviews only.	Umpire Reviews and Player Reviews.
Replays that can be used	The third umpire shall only have access to replays of any camera images. Other technology which may be in use by the broadcaster for broadcast purposes (for example, ball-tracking technology, sound-based edge detection technology, and heat-based edge detection technology) shall not be used during Umpire Reviews.	Any replay, stump microphone audio or technology detailed in paragraph 3.8.1 below.
ICC Technical Officer	Not required.	The ICC shall appoint an independent technology expert (ICC Technical Officer) to be present at every series in which the DRS is used to assist the third umpire and to protect the integrity of the DRS process.

- 1.1.6 The Home Board shall ensure that a separate room is provided for the third umpire and that he/she has access to the television equipment and technology (where DRS is used) so as to be in the best position to facilitate the referral and/or consultation processes referred to in paragraphs 2 (Umpire Review) and 3 (Player Review) below.

2 UMPIRE REVIEW

For televised matches, in the circumstances detailed in paragraphs 2.1, 2.2, 2.3 and 2.4 below, the on-field umpire shall have the discretion to refer the decision to the third umpire or, in the case of paragraphs 2.2, and 2.4, to consult with the third umpire before making the decision.

Save for requesting the umpire to review his/her decision under paragraph 3 (Player Review) below, players may not appeal to the on-field umpires to use the Umpire Review. Breach of this provision may constitute dissent and the player may be subject to disciplinary action under the ICC Code of Conduct for Players and Player Support Personnel.

2.1 Run Out, Stumped, Bowled and Hit Wicket Decisions

- 2.1.1 The relevant on-field umpire shall be entitled to refer an appeal for run-out, stumped, bowled or hit wicket to the third umpire.
- 2.1.2 An on-field umpire wishing to refer a decision to the third umpire shall signal to the third umpire by making the shape of a TV screen with his/her hands.
- 2.1.3 In the case of a referral of a bowled, hit wicket or stumped decision, the third umpire shall first check the fairness of the delivery (all modes of No ball except for the bowler using an Illegal Bowling Action, subject to the proviso that the third umpire may review whether the bowler has used a prohibited Specific Variation under Article 6.2 of the Illegal Bowling Regulations). If the delivery was not a fair delivery the third umpire shall indicate that the batter is Not out and advise the on-field umpire to signal No ball. See also paragraph 2.5 below.
- 2.1.4 Additionally, if the third umpire finds the batter is Out by another mode of dismissal (excluding LBW), or Not out by any mode of dismissal (excluding LBW), he/she shall notify the on-field umpire so that the correct decision is made.
- 2.1.5 If the third umpire decides that the batter is Out, a red light shall be displayed; if the third umpire decides that the batter is Not out, a green light shall be displayed. Should the third umpire be temporarily unable to respond, a white light (where available) shall remain illuminated throughout the period of interruption to signify to the on-field umpires that Umpire Reviews are temporarily unavailable, in which case the decision shall be taken by the on-field umpire. As an alternative to the red/green light system, the replay screen (where available) may be used for the purpose of conveying the third umpire's decision, in line with the ICC Big Screen Policy.

2.2 Caught Decisions, Obstructing the Field

- 2.2.1 Where the bowler's end umpire is unable to decide upon a Fair Catch or a Bump Ball, or if, on appeal from the fielding side, the batter obstructed the field, he/she shall first consult with the striker's end umpire.

- 2.2.2 Should both on-field umpires require assistance from the third umpire to make a decision, the bowler's end umpire shall firstly take a decision on-field after consulting with the striker's end umpire, before consulting by two-way radio with the third umpire. Such consultation shall be initiated by the bowler's end umpire to the third umpire by making the shape of a TV screen with his/her hands, followed by a Soft Signal of Out or Not out made with the hands close to the chest at chest height. If the third umpire advises that the replay evidence is inconclusive, the on-field decision communicated at the start of the consultation process shall stand.
- 2.2.3 The third umpire shall determine whether the batter has been caught, whether the delivery was a Bump Ball, or if the batter obstructed the field. However, in reviewing the television replay(s), the third umpire shall first check the fairness of the delivery for all decisions involving a catch (all modes of No ball except for the bowler using an Illegal Bowling Action, subject to the proviso that the third umpire may review whether the bowler has used a prohibited Specific Variation under Article 6.2 of the Illegal Bowling Regulations) and whether the batter has hit the ball. If the delivery was not a fair delivery or if it is clear to the third umpire that the batter did not hit the ball he/she shall indicate to the bowler's end umpire that the batter is Not out caught, and in the case of an unfair delivery, advise the bowler's end umpire to signal No ball. See also paragraph 2.5 below. Additionally, if it is clear to the third umpire that the batter is Out by another mode of dismissal (excluding LBW), or Not out by any mode of dismissal (excluding LBW), he/she shall notify the bowler's end umpire so that the correct decision can be made.
- 2.2.4 The third umpire shall communicate his/her decision as set out in paragraph 2.1.5.

2.3 Boundary Decisions

- 2.3.1 The bowler's end umpire shall be entitled to refer to the third umpire for a decision on:
- 2.3.1.1 whether a four or six has been scored;
- 2.3.1.2 whether a fielder had any part of her person in contact with the ball when she touched the boundary; or
- 2.3.1.3 whether the fielder had any part of her person in contact with the ball when she had any part of her person grounded beyond the boundary.
- 2.3.2 A decision shall be made immediately and cannot be changed thereafter.
- 2.3.3 If the television evidence is inconclusive as to whether or not a boundary has been scored, the default presumption shall be in favour of no boundary being awarded.
- 2.3.4 Where the bowler's end umpire wishes to use the assistance of the third umpire in this circumstance, he/she shall communicate with the third umpire by use of a two-way radio and the third umpire shall convey his/her decision to the bowler's end umpire by the same method.

- 2.3.5 The third umpire may initiate contact with the on-field umpire by two-way radio if TV coverage shows a boundary line infringement or incident that appears not to have been acted upon by the on-field umpires.

2.4 Batters Running to the Same End

- 2.4.1 Where both batters have run to the same end and the on-field umpires are uncertain over which batter made her ground first, the on-field umpires may consult with the third umpire.
- 2.4.2 The procedure set out in paragraph 2.3.4 shall apply.

2.5 No Balls

- 2.5.1 If the bowler's end umpire is uncertain as to the fairness of the delivery following a dismissal, either affecting the validity of the dismissal or which batter is dismissed, he/she shall be entitled to request the batter to delay leaving the field and to check the fairness of the delivery with the third umpire. Communication with the third umpire shall be by two-way radio.
- 2.5.2 The third umpire shall check all modes of No ball except for the bowler using an Illegal Bowling Action (subject to the proviso that the third umpire may review whether the bowler has used a prohibited Specific Variation under Article 6.2 of the Illegal Bowling Regulations). The third umpire shall apply clause 21.5 when deciding whether a No ball should have been called (and must therefore be satisfied that none of the three conditions in clause 21.5 have been met before calling a No ball).
- 2.5.3 If the delivery was not a fair delivery, the bowler's end umpire shall indicate that the batter is Not out and signal No ball (except in the case of a dismissal for obstructing the field, which may still be effected despite a No ball being called, in which case the bowler's end umpire shall indicate that the relevant batter is Out and additionally call a No ball).
- 2.5.4 If a No ball is called following the check by the third umpire, the batting side shall benefit from the reversal of the dismissal and the one run for the No ball, but shall not benefit from any runs that may subsequently have accrued from the delivery had the on-field umpire originally called a No ball. Where the batters crossed while the ball was in the air before being caught, the batters shall remain at the same ends as if the striker had been dismissed, but no runs shall be credited to the striker even if one (or more) runs were completed prior to the catch being taken.

2.6 Cameras On or Over the Field of Play

- 2.6.1 The on-field umpires shall be entitled to refer to the third umpire for a decision as to whether the ball has at any time during the normal course of play come into contact with any part of the camera, its apparatus or its cables above the playing area, as contemplated in clause 20.1.3.

- 2.6.2 Where an on-field umpire wishes to use the assistance of the third umpire in this circumstance, he/she shall communicate with the third umpire by use of a two-way radio and the third umpire shall convey his/her decision to the bowler's end umpire by the same method.
- 2.6.3 A decision shall be made immediately and cannot be changed thereafter. If the television evidence is inconclusive as to whether or not the ball has come into contact with any part of the camera, its apparatus or its cables above the playing area, the default presumption shall be in favour of no contact having been made.
- 2.6.4 The third umpire may initiate contact with the on-field umpire by two-way radio if TV coverage shows the ball to have been in contact with any part of the camera or its cables above the playing area as envisaged under this paragraph.

3 PLAYER REVIEW

The following paragraphs shall operate in addition to and in conjunction with paragraph 2 (Umpire Review).

3.1 Circumstances in which a Player Review may be requested

- 3.1.1 A player may request a review of any decision taken by the on-field umpires concerning whether or not a batter is dismissed, with the exception of 'Timed Out' (Player Review).
- 3.1.2 No other decisions made by the umpires are eligible for a Player Review with the exception of Fair Catch/Bump Ball (even after the third umpire has been consulted and the decision communicated).
- 3.1.3 Only the batter involved in a dismissal may request a Player Review of an Out decision and only the captain (or acting captain) of the fielding team may request a Player Review of a Not out decision.
- 3.1.4 A decision concerning whether or not a batter is dismissed that could have been the subject of a Umpire Review under paragraph 2 is eligible for a Player Review as soon as it is clear that the on-field umpire has chosen not to initiate the Umpire Review.

3.2 The manner of requesting the Player Review

- 3.2.1 The request shall be made by the player making a 'T' sign with both forearms at head height.
- 3.2.2 The total time elapsed between the ball becoming dead and the review request being made shall be no more than 15 seconds. The only exception permitted shall be when an Umpire Review for Fair Catch or Bump Ball (as permitted in paragraph 2.2 above) is required to answer an appeal for a caught decision, in which case either team is able to request a Player Review of that caught decision within 15 seconds of the decision being communicated. The bowler's end umpire shall provide the relevant player with a prompt after 10 seconds if the request has not been made at that time and the player shall request the review immediately thereafter. If the on-field umpires believe that a request has not been made within the 15 second time limit, they shall decline the request for a Player Review.

- 3.2.3 The captain may consult with the bowler and other fielders, and the two batters may consult with each other prior to deciding whether to request a Player Review. Under no circumstances is any player permitted to query an umpire about any aspect of a decision before deciding on whether or not to request a Player Review. If the on-field umpires believe that the captain or either batter has received direct or indirect input emanating other than from the players on the field, then they may at their discretion decline the request for a Player Review. In particular, signals from the dressing room must not be given.
- 3.2.4 No replays, either at normal speed or slow motion, shall be shown on a big screen to spectators until the 15 second time limit allowed for requesting a Player Review has elapsed. The only exception to this provision is where a Player Review of a caught decision is requested after the Umpire Review of a Fair Catch or Bump Ball has concluded, as detailed in paragraph 3.2.2 above (due to the fact that replays may have been shown on the big screen during that Umpire Review process).
- 3.2.5 Where either on-field umpire initiates an Umpire Review, this does not preclude a player seeking a Player Review of a separate incident from the same delivery. The request for a Player Review may be made after the Umpire Review, provided the request is still within the 15 second time limit described in paragraph 3.2.2 above. (See paragraphs 3.9.2 and 3.9.3 below for the process for addressing both an Umpire and Player Review).
- 3.2.6 A request for a Player Review cannot be withdrawn once it has been made.

3.3 The process of consultation

- 3.3.1 On receipt of an eligible and timely request for a Player Review, the relevant on-field umpire shall make the sign of a shape of a TV screen with his/her hands in the normal way.
- 3.3.2 The relevant on-field umpire shall initiate communication with the third umpire by confirming;
 - 3.3.2.1 That a Player Review has been requested,
 - 3.3.2.2 The mode of dismissal for which the relevant on-field umpire adjudicated the appeal,
 - 3.3.2.3 The decision that has been made (Out or Not out), and;
 - 3.3.2.4 For LBW appeals, where relevant, if the bowler's end umpire believed that the striker made no genuine attempt to play the ball with the bat (the default presumption of the third umpire in the absence of any information on this point from the bowler's end umpire shall be that a genuine attempt to play the ball with the bat was made).
- 3.3.3 A two-way consultation process shall begin to investigate whether there is anything that the third umpire can see or hear which would indicate that the on-field umpire should change his/her original decision.

- 3.3.4 The third umpire shall not withhold any factual information which may help in the decision making process. In particular, in reviewing a dismissal, if the third umpire believes that the batter may instead be Out by any other mode of dismissal, he/she shall advise the on-field umpire accordingly. The process of consultation described in this paragraph in respect of such other mode of dismissal shall then be conducted as if the batter has been given Not out.
- 3.3.5 The third umpire shall initially check all modes of No ball except for the bowler using an Illegal Bowling Action (subject to the proviso that the third umpire may review whether the bowler has used a prohibited Specific Variation under Article 6.2 of the Illegal Bowling Regulations), where appropriate advising the on-field umpire accordingly.
- 3.3.6 If despite the available technology, the third umpire is unable to decide with a high degree of confidence whether the original on-field decision should be changed, then he/she shall report that the replays are 'inconclusive', and that the on-field decision shall stand. The third umpire shall not give answers conveying likelihoods or probabilities.
- 3.3.7 In circumstances where the television technology (all or parts thereof) is not available to the third umpire or fails for whatever reason, the third umpire shall advise the on-field umpire of this fact but still provide any relevant factual information that may be ascertained from the available television replays and other technology.
- 3.3.8 The on-field umpire shall then make his/her decision based on the information provided by the third umpire, any other factual information offered by the third umpire and his/her recollection and opinion of the original incident.
- 3.3.9 The on-field umpire shall reverse his/her decision if the nature of the supplementary information received from the third umpire leads him/her to conclude that his/her original decision was incorrect.

3.4 Review of LBW Decisions

- 3.4.1 In assessing whether a batter is Out LBW in accordance with clause 36, the third umpire shall first judge whether the delivery is fair (as set out in clause 36.1.1), and second, whether or not the ball has touched the bat before being intercepted by any part of the striker's person (as set out in clause 36.1.3).
- 3.4.2 If the batter is still eligible to be Out, the ball-tracking technology shall then present three pieces of information to the third umpire relating to the path of the ball:
- 3.4.2.1 The point of pitching (where applicable) (PITCHING).
- 3.4.2.2 The position of the ball at the point of first interception (IMPACT).
- 3.4.2.3 Whether the ball would have hit the wicket (WICKET).

- 3.4.3 This Decision Review System (DRS) and Third Umpire Protocol includes a category of Umpire's Call, which shall be the conclusion reported where the technology indicates a marginal decision in respect of either the point of first interception or whether the ball would have hit the stumps.

3.4.4 PITCHING

- 3.4.4.1 The interpretation of "pitches in line between wicket and wicket" in clause 36.1.2 shall refer to the position of the centre of the ball at the point of pitching, in relation to the Pitching Zone.
- 3.4.4.2 The Pitching Zone is defined as a two dimensional area on the pitch between both sets of stumps with its boundaries consisting of the base of both sets of stumps and a line between the outside of the outer stumps at each end.
- 3.4.4.3 Where applicable, the ball-tracking technology shall report that the ball pitched in one of the following three areas in relation to the Pitching Zone:

In Line	The centre of the ball was inside the Pitching Zone.
Outside Off	The centre of the ball was outside, and to the off side of, the Pitching Zone.
Outside Leg	The centre of the ball was outside, and to the leg side of, the Pitching Zone.

- 3.4.4.4 Subject to the satisfaction of the other elements of clause 36, the batter can be Out if the ball-tracking technology reports that the ball pitched Outside Off or In Line, but the batter shall be Not out if the ball pitched Outside Leg.

3.4.5 IMPACT

- 3.4.5.1 The interpretation of "the (first) point of impact, even if in above the level of the bails, is between wicket and wicket" in clause 36.1.4 shall refer to the position of the ball at the point of first interception, in relation to the Impact Zone.
- 3.4.5.2 The Impact Zone is defined as a three dimensional space extending between both wickets to an indefinite height and with its boundaries consisting of a line between the outside of the outer stumps at each end.

- 3.4.5.3 The ball-tracking technology shall report that the point of first interception was in one of the following categories in relation to the Impact Zone:

In Line	The centre of the ball was inside the Impact Zone.
Umpire's Call	Some part of the ball was inside the Impact Zone, but the centre of the ball was outside the Impact Zone, with the further sub-category of 'Umpire's Call (off side)' where the centre of the ball was to the off side of the Impact Zone and the bowler's end umpire communicates to the third umpire that no genuine attempt to play the ball was made by the batter.
Outside	No part of the ball was inside the Impact Zone, with the further sub-categories of 'Outside (off)' and 'Outside (leg)' to indicate the location of the point of first interception in relation to the Impact Zone when the bowler's end umpire communicates to the third umpire that no genuine attempt to play the ball was made by the batter.

- 3.4.5.4 Where a Not out decision is being reviewed, and it is judged that the batter has made a genuine attempt to play the ball, the ball-tracking technology must report that the point of first interception was In Line for the batter to be eligible to be given Out, otherwise the batter shall remain Not out.
- 3.4.5.5 Where a Not out decision is being reviewed, and it is judged that the batter has made no genuine attempt to play the ball, the ball-tracking technology must report that the point of impact was In Line, or Umpire's Call (off side), or Outside (off) for the batter to be eligible to be given Out, otherwise the batter shall remain Not out.
- 3.4.5.6 Where an Out decision is being reviewed, and it is judged that the batter has made a genuine attempt to play the ball, the ball-tracking technology must report that the point of first interception was Outside for the decision to be reversed to Not out, otherwise the batter shall remain eligible to be given Out.
- 3.4.5.7 Where an Out decision is being reviewed, and it is judged that the batter has made no genuine attempt to play the ball, the ball-tracking technology must report that the point of first interception was Outside (leg) for the decision to be reversed to Not out, otherwise the batter shall remain eligible to be given Out.

3.4.6 WICKET

- 3.4.6.1 The interpretation of whether "the ball would have hit the wicket" in clause 36.1.5 shall refer to the position of the ball as it either hits or passes the wicket, in relation to the Wicket Zone.
- 3.4.6.2 The Wicket Zone is defined as a two dimensional area whose boundaries are the outside of the outer stumps, the base of the stumps and the bottom of the balls.
- 3.4.6.3 The ball-tracking technology shall report whether the ball would have hit the wicket with reference to the following three categories:

Hitting	The ball was hitting the wicket, and the centre of the ball was inside the Wicket Zone.
Umpire's Call	The ball was hitting the wicket, but the centre of the ball was not inside the Wicket Zone.
Missing	The ball was missing the wicket.

- 3.4.6.4 Where a Not out decision is being reviewed, the ball-tracking technology must report that the ball was Hitting for the batter to be eligible to be given Out, otherwise the batter shall remain Not out.

However, where the evidence shows that the ball was Hitting, the point of first interception was In Line, and the ball pitched In Line or Outside Off, but that:

- The point of first interception was 300cm or more from the stumps; or
- The point of first interception was more than 250cm but less than 300cm from the stumps and the distance between the point of pitching and the point of first interception was less than 40cm,

the on-field decision shall stand (that is, Not out).

- 3.4.6.5 Where an Out decision is being reviewed, the ball-tracking technology must report that the ball was Missing for the on-field decision to be reversed to Not out, otherwise the batter shall remain eligible to be given Out.

- 3.4.7 When the ball strikes the batter on the full, and the evidence provided by the ball-tracking technology indicates that the ball would have pitched before striking or passing the wicket, there will be no information available from that delivery that will allow the ball-tracking technology to accurately predict the height of the ball after pitching.
- 3.4.8 With regard to determining whether the ball would have hit the wicket under these circumstances, the ball-tracking technology shall project the line of the ball in accordance with clause 36.2.3 (it is to be assumed that the path of the ball before interception would have continued after interception, irrespective of whether the ball might have pitched subsequently or not), and display the simulated path of the ball from directly above the wicket.

3.4.9 The third umpire shall advise the bowler's end umpire only on the point of first interception and whether the ball would have hit the stumps (in line with the process set out in paragraph 3.4 above), but shall make no comment on the predicted height of the ball after pitching, which shall remain a judgment of the bowler's end umpire.

3.5 The process for communicating the final decision

3.5.1 For Player Reviews concerning potential dismissals, the relevant on-field umpire shall indicate Out by raising his/her finger above his/her head in a normal yet prominent manner or indicate Not out by the call of 'not out' and by crossing his/her hands in a horizontal position side to side in front and above his/her waist three times. Where the decision is a reversal of the on-field umpire's previous decision, he/she shall make the 'revoke last signal' indication immediately prior to the above.

3.5.2 If the mode of dismissal is not obvious or not the same as that on which the original decision was based, then the umpire shall advise the scorers via the third umpire.

3.6 Number of Player Review requests permitted

3.6.1 In each innings, each team shall be allowed to make a maximum of one Player Review request that is categorised as 'Unsuccessful' (as set out in paragraph 3.6.3 below).

3.6.2 Where a request for a Player Review results in the original on-field decision being reversed, then the Player Review shall be categorised as 'Successful' and shall not count towards the innings limit.

3.6.3 Where a request for a Player Review results in the original on-field decision remaining unchanged (other than in the circumstances set out in paragraphs 3.6.4, 3.6.6 or 3.6.8), the Player Review shall be categorised as 'Unsuccessful'.

3.6.4 Where a request for a Player Review of an LBW decision results in the on-field decision remaining unchanged solely on the basis of an Umpire's Call, the Player Review shall be categorised as 'Unchanged – Umpire's Call'. A Player Review categorised as 'Unchanged – Umpire's Call' shall not count towards the innings limit set out in paragraph 3.6.1.

3.6.5 Where, following a request for a Player Review, the original on-field decision of Out is unchanged, but for a different mode of dismissal from the original on-field decision, then the Player Review shall still be categorised as 'Unsuccessful'.

3.6.6 Where, following a request for a Player Review, the original on-field decision of Not out is unchanged on account of the delivery being a No ball (for any reason), thereby not requiring any further evaluation, the Player Review shall not be counted as 'Unsuccessful' and accordingly shall not count towards the innings limit set out in paragraph 3.6.1.

3.6.7 Where a Player Review and an Umpire Review are requested from the same delivery and the decision of the third umpire from the Umpire Review renders the Player Review unnecessary (see paragraphs 3.9.2 and 3.9.3), the Player Review request shall be disregarded and accordingly shall not count towards the innings limit set out in paragraph 3.6.1.

3.6.8 A Player Review categorised as 'Unsuccessful' may be reinstated by the ICC Match Referee at his/her sole discretion (if appropriate after consultation with the ICC Technical Official and/or the television broadcast director) if the Player Review could not properly be concluded due to a failure of the technology. Any such decision shall be final and shall be taken as soon as possible, being communicated to both teams once all the relevant facts have been ascertained by the ICC Match Referee. A Player Review categorised as 'Unsuccessful' shall not be reinstated if, despite any technical failures, the correct decision could still have been made using the other available technology. Similarly, a Player Review categorised as 'Unsuccessful' shall not be reinstated where the technology worked as intended, but the evidence gleaned from its use was inconclusive.

3.6.9 The third umpire shall be responsible for counting the number Player Reviews categorised as 'Unsuccessful' and shall advise the on-field umpires once either team has exhausted their allowance for the innings.

3.6.10 The scoreboard shall display, for the innings in progress, the number of Player Reviews remaining available to each team.

CATEGORY OF PLAYER REVIEW	OUTCOME OF PLAYER REVIEW	CONSEQUENCE OF PLAYER REVIEW
Successful (paragraph 3.6.2)	On-field decision reversed	Does not count towards innings limit set out in paragraph 3.6.1
Unsuccessful (paragraphs 3.6.3 and 3.6.5)	On-field decision unchanged	Counts towards innings limit set out in paragraph 3.6.1
Unchanged – Umpire's Call (paragraph 3.6.4)	On-field decision unchanged	Does not count towards innings limit set out in paragraph 3.6.1
No ball – no evaluation required (paragraph 3.6.6)	On-field decision unchanged	Does not count towards innings limit set out in paragraph 3.6.1
Failure of technology (paragraph 3.6.8)	On-field decision unchanged	Does not count towards innings limit set out in paragraph 3.6.1

3.7 Dead ball

- 3.7.1 If following a Player Review request, an original decision of Out is changed to Not out, then the ball is still deemed to have become dead when the original decision was made (as per clause 20.1.1.3). The batting side, while benefiting from the reversal of the dismissal, shall not benefit from any runs that may subsequently have accrued from the delivery had the on-field umpire originally made a Not out decision, other than any No ball penalty that could arise under paragraph 3.3.5 above.
- 3.7.2 If an original decision of Not out is changed to Out, the ball shall retrospectively be deemed to have become dead from the moment of the dismissal event. All subsequent events, including any runs scored, shall be ignored.

3.8 Use of technology

- 3.8.1 The following technology may be used by the third umpire during a Player Review:
- 3.8.1.1 Replays, at any speed, from any available broadcast camera
- 3.8.1.2 Sound from the stump microphones with the replays at normal speed and slow motion
- 3.8.1.3 Approved ball-tracking technology:
- HawkEye (HawkEye Innovations), or;
 - VirtualEye (ARL)
- 3.8.1.4 Approved sound-based edge detection technology:
- Real-Time Snickometer (BBG Sports), or;
 - UltraEdge (HawkEye Innovations)
- 3.8.1.5 Approved heat-based edge detection technology:
- Hot Spot cameras (BBG Sports)
- 3.8.1.6 LED Wickets (using the lights to indicate if the wicket is broken, as set out in paragraph 4.2):
- Zing Bails and Stumps
- 3.8.2 In addition, other forms of technology may be used subject to the ICC being satisfied that the required standards of accuracy and time efficiency can be met.
- 3.8.3 Where practical usage or further testing indicates that any of the above forms of technology cannot reliably provide accurate and timely information, then it may be removed prior to or during a match. The final decision regarding the technology to be used in a given match shall be taken by the ICC Match Referee in consultation with the ICC Technical Official, ICC management and the competing teams' governing bodies.

3.9 Combining Umpire Review with Player Review

- 3.9.1 If an Umpire Review (under paragraph 2) and a request for a Player Review (under paragraph 3) are made following the same delivery but relating to separate modes of dismissal, the following process shall apply.
- 3.9.2 The Umpire Review shall be carried out prior to the Player Review if all of the following conditions apply:
- 3.9.2.1 The Player Review has been requested by the fielding side
- 3.9.2.2 The Umpire Review and the Player Review both relate to the dismissal of the same batter
- 3.9.2.3 If the batter is out, the number of runs scored from the delivery would be the same for both modes of dismissal
- 3.9.2.4 If the batter is out, the batter on strike for the next delivery would be the same for both modes of dismissal.
- 3.9.3 If the Umpire Review leads the third umpire to make a decision of Out, then this shall be displayed in the usual manner and the Player Review shall not be undertaken. If the Umpire Review results in a Not out decision, then the third umpire shall make no public decision but shall proceed to address the request for a Player Review.
- 3.9.4 For illustration, following an LBW appeal which is given Not out by the bowler's end umpire, the striker sets off for a run, is sent back and there is an appeal for her run out. The players request that the LBW decision is reviewed and the umpires request that the run out be reviewed. The four criteria above are satisfied, so the run out referral is determined first. Should the appeal for run out be Out, then there is no requirement for the LBW review to take place.
- 3.9.5 In all other circumstances, the incidents shall be addressed in chronological order. If the conclusion from the first incident is that a batter is dismissed, then the ball would be deemed to have become dead at that point, rendering investigation of the second incident unnecessary.

4 INTERPRETATION OF PLAYING CONDITIONS

- 4.1 When using a replay to determine the moment at which the wicket has been put down (as per clause 29.1), the third umpire shall deem this to be the first frame in which one of the bails is shown (or can be deduced) to have lost all contact with the top of the stumps and subsequent frames show the bail permanently removed from the top of the stumps.
- 4.2 Where LED Wickets are used (as provided for in paragraph 3.8.1.6) the moment at which the wicket has been put down (as per clause 29.1) shall be deemed to be the first frame in which the LED lights are illuminated and subsequent frames show the bail permanently removed from the top of the stumps.

APPENDIX E

CALCULATIONS

Table 1: Calculation sheet for use when a delay or interruptions occur in the First Innings

Time

Net playing time available at start of the match	150 minutes	(A)
Time innings in progress	_____	(B)
Playing time lost	_____	(C)
Extra time available	_____	(D)
Time made up from reduced interval	_____	(E)
Effective playing time lost [C – (D + E)]	_____	(F)
Remaining playing time available (A – F)	_____	(G)
G divided by 3.75 (to 2 decimal places)	_____	(H)
Max overs per team [H/2] (round up fractions)	_____	(I)
Maximum overs per bowler [I/5]	_____	
Duration of Powerplay Overs (initial, batting side) _____ + _____		

Rescheduled Playing Hours

First session to commence or recommence	_____	(J)
Length of innings [I x 3.75] (round up fractions)	_____	(K)
Rescheduled first innings cessation time [J + (K – B)]	_____	(L)
Length of interval	_____	(M)
Second innings commencement time [L + M]	_____	(N)
Rescheduled second innings cessation time [N + K]	_____	*(O)

* Ensure that the match is not finishing earlier than the original or rescheduled cessation time by applying clause 13.7.2. If so, add at least one over to each team and recalculate (I) to (O) above to prevent this from happening.

Table 2: Calculation sheet to check whether an interruption during the First Innings should terminate the innings

Proposed re-start time	_____	(P)
Rescheduled cut-off time allowing for full use of any extra time provision	_____	(Q)
Minutes between P and Q	_____	(R)
Potential overs to be bowled [R/3.75] (round up fractions)	_____	(S)
Number of complete overs faced to date in first innings	_____	(T)
If S is greater than T then revert to Table 1		
If S is less than or equal to T then the first innings is terminated – go to Table 3		

Table 3: Calculation sheet for the start of the Second Innings

Maximum overs to be bowled:

(If first innings was terminated, S from Table 2)	_____	(A)
Scheduled length of innings: [A x 3.75] (round up fractions)	_____	(B)
Start time	_____	(C)
Scheduled cessation time [C + B]	_____	(D)
Overs per bowler and fielding restrictions		
Maximum overs per bowler [A/5]	_____	overs
Duration of Powerplay overs (initial, batting side) _____ + _____		overs

Table 4: Calculation sheet for use when interruption occurs after the start of the Second Innings

Time

Time at start of innings	_____	(A)
Time at start of interruption	_____	(B)
Time innings in progress	_____	(C)
Restart time	_____	(D)
Length of interruption [D – B]	_____	(E)
Additional time available:	_____	(F)
(Any unused provision for 'Extra Time' or for earlier than scheduled start of second innings)		
Total playing time lost [E – F]	_____	(G)

Overs

Maximum overs at start of innings	_____	(H)
Overs lost [G/3.75] (rounded down)	_____	(I)
Adjusted maximum length of innings [H – I]	_____	(J)
Rescheduled length of innings [J x 3.75 rounded up]	_____	(K)
Amended cessation time of innings [D + (K – C)]	_____	(L)

Overs per bowler and Fielding Restrictions

Maximum overs per bowler [J/5]	_____	overs
Duration of Powerplay overs (initial, batting side)	_____ + _____	overs

APPENDIX F

PROCEDURE FOR THE SUPER OVER

The following procedure shall apply if the playing conditions provide for a Super Over to decide the winner of a tied match.

- 1 If the match is tied a Super Over is played. If the Super Over is a tie, then subsequent Super Overs shall be played until there is a winner. Unless exceptional circumstances arise, there shall be an unlimited number of Super Overs played to achieve a result. (see Clause 24 below).
- 2 The Super Over involves each team facing one over (unless all out earlier), and the winner shall be the team that scores the most runs from its one over innings.
- 3 The loss of two wickets in the over ends the team's one over innings.
- 4 Each team shall be allowed to make one unsuccessful Player Review in each innings of the Super Over. This entitlement shall apply irrespective of the number of unsuccessful Player Review requests made during the match itself.
- 5 Subject to weather conditions the Super Over will take place on the scheduled day of the match at a time to be determined by the ICC Match Referee. In normal circumstances it shall commence 5 minutes after the conclusion of the match.
- 6 The Super Over will be played until completion, but if there are any delays or interruptions during the Super Over, Extra Time (taken from the start of the first Super Over) is allocated to complete the Super Over or any subsequent Super Overs. The amount of extra time allocated to the Super Over is the greater of;
 - a. the gap between the time at which the match ended and the time the original match would have been scheduled to finish had the entire extra time provision been utilized, or
 - b. 20 minutes.

Should play be delayed prior to or during the Super Over(s) once the playing time lost exceeds the Extra Time allocated, the Super Over(s) shall be abandoned.
- 7 The Super Over shall take place on the pitch allocated for the match (the designated pitch) unless otherwise determined by the umpires in consultation with the Ground Authority and the ICC Match Referee.
- 8 Only nominated players in the match (including activated concussion replacements) may participate in the Super Over. Should any player (including the batters and bowler) be unable to continue to participate in the Super Over due to injury, illness or other wholly acceptable reasons, the relevant Playing Conditions as they apply in the match shall also apply in the Super Over.
- 9 Any penalty time being served in the match shall be carried forward to the Super Over.

- 10 The umpires shall stand at the same end as that in which they finished the match.
- 11 The team batting second in the match shall bat first in the Super Over.
- 12 The captain of the fielding team (or her nominee) shall select the ball with which the fielding team shall bowl its over in the Super Over from the box of spare balls provided by the umpires (which shall include the balls used in the match, but no new balls). The team fielding first in the Super Over shall have first choice of ball. The team fielding second may choose to use the same ball as chosen by the team bowling first. If the ball needs to be changed, the Playing Conditions shall apply.
- 13 The fielding side shall choose the end from which it is to bowl its one over.
- 14 Each team's over is played with the same fielding restrictions as apply for the last over in a match played under the ICC Twenty20 International Playing Conditions.
- 15 The winners of the Super Over shall be the team which scored the most runs as per normal playing conditions and irrespective of the number of wickets lost. (See also Clause 3 above).

TIED SUPER OVER - REPEATING THE SUPER OVER PROCEDURE

- 16 If the Super Over is tied, then subsequent Super Overs will be played until there is a winner.
- 17 In normal circumstances any subsequent Super Over will start 5 minutes after the previous Super Over ends. The interval shall be 5 minutes.
- 18 The team batting second in the previous Super Over will bat first in the subsequent Super Over.
- 19 The balls selected for use by each team in the previous Super Over shall be used again by the same team in subsequent Super Overs.
- 20 The fielding side must bowl its over in a subsequent Super Over from the opposite end to which it bowled from in the previous Super Over.
- 21 Any batter dismissed in any previous Super Over shall be ineligible to bat in the following Super Over.
- 22 The bowler who bowled the over in the previous Super Over shall be ineligible to bowl the over in the subsequent Super Over.
- 23 All other playing conditions will be the same as for the initial Super Over.
- 24 In circumstances where there are unavoidable time constraints, such as, but not limited to, double-header matches which do not allow the completion of multiple Super Over(s) the Home Board may, prior to the start of the series and by notification to the participating teams, limit the number of possible Super Overs.

EXAMPLES - EXTRA TIME AVAILABLE FOR THE SUPER OVER.

Example 1: The match is scheduled to finish at 10.20pm, with 60 minutes of extra time available to be used. The scheduled cut-off time if all the available extra time is used would be 11.20pm. The match runs over time and finishes in a tie at 10.35pm. The Super Over is scheduled to start 5 minutes later at 10.40pm. The extra time available to complete the Super Over would be 40 minutes (as per Clause 5a above).

- The Super Over starts on time but is interrupted at 10.50pm for 10 minutes (leaving 30 minutes of extra time still available).
- Play resumes at 11.00pm with a tied Super Over occurring.
- The second super over is being played but is interrupted at 11.15pm.
- Play does not resume within 30 minutes (being the amount of extra time still available), therefore the Super Over process is abandoned, and the match is a tie.

Example 2: The same match is scheduled to finish at 10.20pm, but with 30 minutes of extra time available to be used. The scheduled cut-off time if all the available extra time is used would be 10.50pm. The match runs over time and finishes in a tie at 10.35pm. The Super Over is scheduled to start 5 minutes later at 10.40pm. The extra time available to complete the Super Over would be 20 minutes (as per Clause 5b above).

APPENDIX G

USE OF ELECTRONIC COMMUNICATIONS EQUIPMENT

The use of electronic communication devices and equipment of any kind to communicate with players on the field of play shall not be permitted, except that broadcaster to player communication shall, with the prior consent of the participating countries, be allowed.

ICC CODE OF CONDUCT FOR PLAYERS AND PLAYER SUPPORT PERSONNEL

ICC CODE OF CONDUCT FOR PLAYERS AND PLAYER SUPPORT PERSONNEL

CONTENTS

ARTICLE 1	SCOPE AND APPLICATION	13.2
ARTICLE 2	CODE OF CONDUCT OFFENCES	13.3
ARTICLE 3	REPORTING AN ALLEGED OFFENCE UNDER THE CODE OF CONDUCT	13.14
ARTICLE 4	NOTIFICATION PROCEDURE	13.18
ARTICLE 5	THE DISCIPLINARY PROCEDURE	13.20
ARTICLE 6	STANDARD OF PROOF AND EVIDENCE	13.28
ARTICLE 7	SANCTIONS ON PLAYERS AND PLAYER SUPPORT PERSONNEL	13.28
ARTICLE 8	APPEALS	13.36
ARTICLE 9	RECOGNITION OF DECISIONS	13.39
ARTICLE 10	SANCTIONS AND COSTS ASSESSED AGAINST NATIONAL CRICKET FEDERATIONS	13.39
ARTICLE 11	AMENDMENT AND INTERPRETATION OF THE CODE OF CONDUCT	13.40
APPENDIX 1	DEFINITIONS	13.41
APPENDIX 2	MINIMUM OVER RATE REQUIREMENTS, CALCULATION, REPORTING AND DISCIPLINARY PROCESS AND SANCTIONS	13.44
APPENDIX 3	MATCH FEES	13.47
APPENDIX 4	EXPEDITED PROCEDURE FOR CODE OF CONDUCT OFFENCES OCCURRING DURING AN ICC EVENT	13.48

INTRODUCTION

The ICC is the international federation responsible for the global governance of the sport of cricket and the Code of Conduct for Players and Player Support Personnel (the “**Code of Conduct**”) is adopted and implemented as part of the ICC’s continuing efforts to maintain the public image, popularity and integrity of cricket by providing: (a) an effective means to deter any participant from conducting themselves improperly on and off the field-of-play or in a manner that is contrary to the Spirit of Cricket; and (b) a robust and proportionate disciplinary procedure pursuant to which all matters of improper conduct can be dealt with fairly, with certainty and in an expeditious manner.

Unless otherwise indicated, references to Articles and Appendices are to articles and appendices of the Code of Conduct. Words in italicised text in the Code of Conduct are defined terms and their definitions are set out in Appendix 1.

ARTICLE 1 – SCOPE AND APPLICATION

- 1.1 All Players and Player Support Personnel are automatically bound by and required to comply with all of the provisions of the Code of Conduct. Accordingly, by their participation (in the case of a Player) or assistance in a Player’s participation (in the case of a Player Support Personnel) in an International Match, such Players or Player Support Personnel shall be deemed to have agreed:
 - 1.1.1 that it is their personal responsibility to familiarise themselves with all of the requirements of the Code of Conduct, including what conduct constitutes an offence under the Code of Conduct;
 - 1.1.2 to submit to the exclusive jurisdiction of any Match Referee, Judicial Commissioner or Appeal Panel convened under the Code of Conduct to hear and determine charges brought (and any appeals in relation thereto) pursuant to the Code of Conduct; and
 - 1.1.3 not to bring any proceedings in any court or other forum that are inconsistent with the foregoing submission to the jurisdiction of the Match Referee, Judicial Commissioner or Appeal Panel.
- 1.2 All Players and Player Support Personnel shall continue to be bound by and required to comply with the Code of Conduct until he/she has not participated (in the case of a Player), or assisted a Player’s participation (in the case of a Player Support Personnel) in an International Match for a period of three (3) months from the date of his/her last participation and the ICC shall continue to have jurisdiction over him/her under the Code of Conduct thereafter in respect of matters taking place prior to that point.
- 1.3 Without prejudice to Articles 1.1 and 1.2, the ICC and the National Cricket Federations shall be responsible for promoting Code of Conduct awareness and education amongst all Players and Player Support Personnel.
- 1.4 It is acknowledged that certain Players and Player Support Personnel may also be subject to other rules of National Cricket Federations that govern discipline and/or conduct, and that the same conduct of such Players and/or Player Support Personnel may implicate not only the Code of Conduct but also such other rules that may apply. For the avoidance of any doubt, Players and Player Support Personnel acknowledge and agree that: (a) the Code of Conduct is not intended to limit the responsibilities of any Player or Player Support Personnel under

such other rules; and (b) nothing in such other rules shall be capable of removing, superseding or amending in any way the jurisdiction of the Match Referee, Judicial Commissioner or Appeal Panel to determine matters properly arising pursuant to the Code of Conduct.

- 1.5 For the avoidance of any doubt:
 - 1.5.1 all Umpires and Match Referees officiating in any International Matches are automatically bound by and required to comply with all of the provisions of the ICC Code of Conduct for Match Officials and Match Official Support Personnel; and
 - 1.5.2 where a representative side of a National Cricket Federation participates in an International Tour Match against a domestic or invitational team, for the purposes of their participation in such International Tour Match:
 - 1.5.2.1 all Players and Player Support Personnel representing the National Cricket Federation’s representative side are automatically bound by, required to comply with, and shall submit themselves to the jurisdiction of this Code of Conduct; and
 - 1.5.2.2 all players or player support personnel representing the domestic or invitational team shall not be bound by this Code of Conduct. Instead, such individuals will be bound by, required to comply with, and shall submit themselves to the jurisdiction of the relevant National Cricket Federation’s own applicable rules of conduct.

ARTICLE 2 – CODE OF CONDUCT OFFENCES

The Preamble of the ICC Standard Test Match, ODI and T20I Playing Conditions, sets out the definition of the Spirit of Cricket, as follows:

“Preamble – The Spirit of Cricket

Cricket owes much of its appeal and enjoyment to the fact that it should be played not only according to the Laws (which are incorporated within these Playing Conditions), but also within the Spirit of Cricket.

The major responsibility for ensuring fair play rests with the captains, but extends to all players, umpires and, especially in junior cricket, teachers, coaches and parents.

Respect is central to the Spirit of Cricket.

Respect your captain, team-mates, opponents and the authority of the umpires.

Play hard and play fair.

Accept the umpire’s decision.

Create a positive atmosphere by your own conduct, and encourage others to do likewise.

Show self-discipline, even when things go against you.

Congratulate the opposition on their successes, and enjoy those of your own team.

Thank the officials and your opposition at the end of the match, whatever the result.

Cricket is an exciting game that encourages leadership, friendship and teamwork, which brings together people from different nationalities, cultures and religions, especially when played within the Spirit of Cricket.”

The conduct described in Articles 2.1 to 2.22 amounts to conduct which breaches the Spirit of Cricket and therefore, if committed by a Player or Player Support Personnel, shall amount to an offence by such Player or Player Support Personnel under the Code of Conduct.

COMMENT: Where considered helpful, guidance notes have been provided in text boxes beneath the description of a particular offence. Such notes are intended only to provide guidance as to the nature and examples of certain conduct that might be prohibited by a particular Article and should not be read as an exhaustive or limiting list of conduct that may be prohibited by such Article.

The Code of Conduct offences cover a variety of different behaviours and levels of seriousness. It is not intended to penalize trivial behavior. For the purpose of determining the appropriate sanction for an offence, levels of charging have been assigned for each offence, ranging from Level 1 for conduct of a minor nature, up to Level 4 for conduct of an extremely serious nature. Where an offence is alleged to have been committed, the individual reporting the alleged offence must determine which of the assigned levels of offence is appropriate for the conduct in question. Reports can only be laid at the levels identified in respect of each particular offence below.

For the purposes of the Code of Conduct, the phrase “during an International Match” should be interpreted broadly to cover all conduct which takes place at the ground on the day of an International Match, and not just conduct which takes place on the field of play. It will therefore include conduct which takes place off the field of play, for example in the changing rooms, or during any of the intervals in the match.

For the avoidance of doubt, the ICC’s jurisdiction to take action against a Player or Player Support Personnel under this Code of Conduct is limited to incidents which take place (i) during, or in relation to, an International Match or (ii) during, or in relation to, an ICC Event. In circumstances where a Player or Player Support Personnel is involved in an off-field incident which may warrant action under this Code of Conduct and any code of conduct or disciplinary rules of the Player or Player Support Personnel’s National Cricket Federation, the ICC will consult with the relevant National Cricket Federation in order to determine what the most appropriate course of action against the Player or Player Support Personnel should be.

2.1	EXCESSIVE APPEALING DURING AN INTERNATIONAL MATCH
Note:	For the purpose of Article 2.1, ‘excessive’ may include (a) repeated appealing of the same decision; (b) repeated appealing of different decisions when the bowler/fielder knows the batter is not out with the intention of placing the Umpire under pressure; (c) charging or advancing towards the Umpire in an aggressive manner when appealing; or (d) celebrating a dismissal without appealing to the Umpire when a decision is required. It is not intended to prevent loud or enthusiastic appealing.
Level 1	✓
Level 2	Not applicable
Level 3	Not applicable
Level 4	Not applicable

2.2	ABUSE OF CRICKET EQUIPMENT OR CLOTHING, GROUND EQUIPMENT OR FIXTURES AND FITTINGS DURING AN INTERNATIONAL MATCH.
Note:	Article 2.2 includes any action(s) outside the course of normal cricket actions, such as hitting or kicking the wickets and any action(s) which deliberately (i.e. intentionally), recklessly or negligently (in either case even if accidental) results in damage to the advertising boards, boundary fences, dressing room doors, mirrors, windows and other fixtures and fittings. For example, this offence may be committed, without limitation, when a Player swings his/her bat vigorously in frustration and causes damage to an advertising board.
Level 1	✓
Level 2	Not applicable
Level 3	Not applicable
Level 4	Not applicable

2.3	USE OF AN AUDIBLE OBSCENITY DURING AN INTERNATIONAL MATCH.
Note:	Article 2.3 covers the use of words commonly known and understood to be offensive, obscene and/or profane (in any language) and which can be heard by the spectators and/or the viewing public whether by way of the stump-microphone or otherwise. This conduct may include, for example, swearing in frustration at one’s own play or fortune.
Level 1	✓
Level 2	Not applicable
Level 3	Not applicable
Level 4	Not applicable

2.4	DISOBEYING AN UMPIRE’S INSTRUCTION DURING AN INTERNATIONAL MATCH
Note:	Article 2.4 includes any repeated failure to comply with the instruction or directive of an Umpire during an International Match.
Level 1	✓
Level 2	Not applicable
Level 3	Not applicable
Level 4	Not applicable

2.5	USING LANGUAGE, ACTIONS OR GESTURES WHICH DISPARAGE OR WHICH COULD PROVOKE AN AGGRESSIVE REACTION FROM A BATTER UPON HIS/HER DISMISSAL DURING AN INTERNATIONAL MATCH.
Note:	<p>Article 2.5 includes any language, action or gesture used by a Player and directed towards a batter upon his/her dismissal which has the potential to provoke an aggressive reaction from the dismissed batter, whether or not any reaction results, or which could be considered to disparage or demean the dismissed batter, regardless of whether the batter him/herself feels disparaged or demeaned (in other words, a 'send-off'). Without limitation, Article 2.5 includes: (a) excessive celebration directed at and in close proximity to the dismissed batter; (b) verbally abusing the dismissed batter; and (c) pointing or gesturing towards the pavilion.</p> <p>Nothing in this Article 2.5 is, however, intended to stop Players celebrating, in an appropriate fashion, the dismissal of the opposing team's batter.</p>
Level 1	✓
Level 2	Not applicable
Level 3	Not applicable
Level 4	Not applicable

2.6	USING A GESTURE THAT IS OBSCENE, OFFENSIVE OR INSULTING DURING AN INTERNATIONAL MATCH.
Note:	<p>Article 2.6 includes, without limitation, obscene gestures which are not directed at another person.</p> <p>When assessing the seriousness of the breach, the following factors (without limitation) shall be taken into account: (i) the context of the particular situation; and (ii) whether the gesture is likely to: (a) be regarded as obscene; (b) give offence; or (c) insult another person.</p> <p>This offence is not intended to cover any use of gestures that are likely to offend another person on the basis of their race, religion, gender, colour, descent, national or ethnic origin. Such conduct is prohibited under the ICC's Anti-Racism Code and must be dealt with according to the procedures set out therein.</p>
Level 1	✓
Level 2	Not applicable
Level 3	Not applicable
Level 4	Not applicable

2.7	PUBLIC CRITICISM OF, OR INAPPROPRIATE COMMENT IN RELATION TO AN INCIDENT OCCURRING IN AN INTERNATIONAL MATCH OR ANY PLAYER, PLAYER SUPPORT PERSONNEL, MATCH OFFICIAL OR TEAM PARTICIPATING IN ANY INTERNATIONAL MATCH, IRRESPECTIVE OF WHEN SUCH CRITICISM OR INAPPROPRIATE COMMENT IS MADE.
Note:	<p>Without limitation, Players and Player Support Personnel will breach Article 2.7 if they publicly criticise the Match Officials or denigrate a Player or team against which they have played in relation to incidents which occurred in an International Match. When assessing the seriousness of the breach, without limitation, the context within which the comments have been made and the gravity of the offending comments must be taken into account.</p> <p>For the avoidance of doubt, any posting by a Player or Player Support Personnel of comments on a social media platform (including, without limitation, Facebook, Instagram, Twitter, YouTube and LinkedIn) shall be deemed to be 'public' for the purposes of this offence. Consequently, a Player or Player Support Personnel may breach Article 2.7 where they criticise or make an inappropriate comment in relation to an incident occurring in an International Match or any Player, Player Support Personnel, Match Official or team participating in any International Match in any posting they make on a social media platform.</p>
Level 1	✓
Level 2	✓
Level 3	Not applicable
Level 4	Not applicable

2.8	SHOWING DISSENT AT AN UMPIRE'S DECISION DURING AN INTERNATIONAL MATCH.
Note:	<p>Without limitation, Article 2.8 includes: (a) excessive, obvious disappointment with an Umpire's decision; (b) an obvious delay in resuming play or leaving the wicket; (c) shaking the head; (d) pointing or looking at the inside edge when given out lbw; (e) pointing to the pad or rubbing the shoulder when caught behind; (f) snatching the cap from the Umpire; (g) requesting a referral to the TV Umpire (other than in the context of a legitimate request for a referral as may be permitted in such International Match); and (h) arguing or entering into a prolonged discussion with the Umpire about his/her decision.</p> <p>This offence is not intended to punish a batter showing his/her instinctive disappointment at his/her dismissal.</p> <p>When assessing the seriousness of the breach, the following factors (without limitation) should be considered: (i) whether the conduct contains an element of anger or abuse which is directed at the Umpire or the Umpire's decision; (ii) whether there is excessive delay in resuming play or leaving the wicket; or (iii) whether there is persistent re-reference to the incident over time.</p> <p>It shall not be a defence to any charge brought under this Article to show that the Umpire might have, or in fact did, get any decision wrong.</p>
Level 1	✓
Level 2	✓
Level 3	Not applicable
Level 4	Not applicable

2.9	THROWING A BALL (OR ANY OTHER ITEM OF CRICKET EQUIPMENT SUCH AS A WATER BOTTLE) AT OR NEAR A PLAYER, PLAYER SUPPORT PERSONNEL, UMPIRE, MATCH REFEREE OR ANY OTHER THIRD PERSON IN AN INAPPROPRIATE AND/OR DANGEROUS MANNER DURING AN INTERNATIONAL MATCH.
Note:	This offence will not prohibit a fielder or bowler from returning the ball to the stumps in the normal fashion, or from throwing the ball at the stumps or to a teammate when attempting a run out. When assessing the seriousness of the offence, the following factors (without limitation) shall be taken into account: (i) the context of the particular situation, including, without limitation, whether the action was deliberate, reckless, negligent, and/or avoidable; (ii) whether the ball/object struck the other person; (iii) the speed at which the ball/object was thrown; and (iv) the distance from which the ball/object was thrown.
Level 1	✓
Level 2	✓
Level 3	Not applicable
Level 4	Not applicable

2.10	ANY OF THE FOLLOWING CONDUCT WHICH CONSTITUTES 'UNFAIR PLAY' UNDER CLAUSE 41 OF THE ICC STANDARD TEST, ODI AND T20I PLAYING CONDITIONS: 2.10.1 DELIBERATE ATTEMPT TO DISTRACT STRIKER. 2.10.2 DELIBERATE DISTRACTION, DECEPTION OR OBSTRUCTION OF BATTER 2.10.3 BOWLING OF DANGEROUS AND UNFAIR SHORT PITCHED DELIVERIES. 2.10.4 BOWLING OF DANGEROUS AND UNFAIR NON-PITCHING DELIVERIES. 2.10.5 BOWLING OF DELIBERATE NON-PITCHING DELIVERIES. 2.10.6 BOWLING OF DELIBERATE FRONT FOOT NO BALLS. 2.10.7 TIME WASTING BY ANY PLAYER OR TEAM. 2.10.8 FIELDER CAUSING DELIBERATE OR AVOIDABLE DAMAGE TO THE PITCH. 2.10.9 BOWLER RUNNING ON PROTECTED AREA. 2.10.10 BATTER CAUSING DELIBERATE OR AVOIDABLE DAMAGE TO THE PITCH. 2.10.11 STRIKER IN THE PROTECTED AREA. 2.10.12 BATTER STEALING A RUN. 2.10.13 UNFAIR ACTIONS NOT COVERED ELSEWHERE IN CLAUSE 41 OF THE ICC STANDARD TEST MATCH, ODI AND T20I PLAYING CONDITIONS.
Note:	The offence supplements and does not replace ICC Standard Test Match, ODI and T20I Playing Conditions clauses 41.4 to 41.19. When assessing the seriousness of the offence, the following factors (without limitation) shall be taken into account: (i) the context of the particular situation, including, without limitation and where relevant, whether the action was deliberate, reckless, negligent, and/or avoidable; (ii) the potential of the action to injure an opponent; and (iii) the degree of advantage offered by the 'unfair play'.
Level 1	✓
Level 2	✓
Level 3	Not applicable
Level 4	Not applicable

2.11	ANY ATTEMPT TO MANIPULATE AN INTERNATIONAL MATCH FOR INAPPROPRIATE STRATEGIC OR TACTICAL REASONS.
Note:	Article 2.11 is intended to prevent the manipulation of International Matches for inappropriate strategic or tactical reasons (such as when a team deliberately loses a pool Match in an ICC Event in order to affect the standings of other teams in that ICC Event). It might also apply to the inappropriate manipulation of a net run rate or accumulation of bonus points or otherwise. Article 2.11 is not intended to cover any corrupt or fraudulent acts (including any use of inside information and/or related betting activity). Such conduct is prohibited under the ICC's Anti-Corruption Code and must be dealt with according to the procedures set out therein. The Team Captain of any team guilty of such conduct shall be held responsible (and subject to sanction) for any offence found to have been committed under this Article.
Level 1	Not applicable.
Level 2	✓
Level 3	Not applicable
Level 4	Not applicable

2.12	INAPPROPRIATE PHYSICAL CONTACT WITH A PLAYER, PLAYER SUPPORT PERSONNEL, UMPIRE, MATCH REFEREE OR ANY OTHER PERSON (INCLUDING A SPECTATOR) DURING AN INTERNATIONAL MATCH.
Note:	Any form of inappropriate physical contact is prohibited in cricket. Without limitation, Players will breach this regulation if they deliberately, recklessly and/or negligently walk or run into or shoulder another Player or Umpire. When assessing the seriousness of the breach, the following factors (without limitation) shall be taken into account: (i) the context of the particular situation, including, without limitation, whether the contact was deliberate (i.e. intentional), reckless, negligent, and/or avoidable; (ii) the force of the contact; (iii) any resulting injury to the person with whom contact was made; and (iv) the person with whom contact was made.
Level 1	✓ (Level 1 is available only in the case of contact with Players, Player Support Personnel or any other person).
Level 2	✓ (Level 2 is available only in the case of contact with Players, Player Support Personnel or any other person).
Level 3	✓ (Level 3 is available only in the case of contact with Umpires and Match Referees.)
Level 4	✓ (Level 4 is available only in the case of contact with Umpires and Match Referees.)

2.13	PERSONAL ABUSE OF A PLAYER, PLAYER SUPPORT PERSONNEL, UMPIRE OR MATCH REFEREE DURING AN INTERNATIONAL MATCH.
Note:	<p>Article 2.13 is intended to cover a Player or Player Support Personnel directing language of a personal, insulting, obscene and/or offensive nature at any Player, Player Support Personnel, Umpire or Match Referee during an International Match. It is also intended to cover language of a personal, insulting, obscene and/or offensive nature relating to a family member of the Player, Player Support Personnel, Umpire or Match Referee at whom it is directed.</p> <p>When considering the seriousness of the breach, the following factors (without limitation) shall be considered: (i) whether such language was excessive and/or orchestrated; and (ii) the person at whom the language was directed, i.e. whether they were a Player, Player Support Personnel, Umpire, Match Referee or other person.</p> <p>This offence is not intended to cover any use of language that is likely to offend another person on the basis of their race, religion, gender, colour, descent, national or ethnic origin. Such conduct is prohibited under the ICC's Anti-Racism Code and must be dealt with according to the procedures set out therein.</p>
Level 1	Not applicable
Level 2	✓ (Level 2 is not available in the case of personal abuse of an Umpire or Match Referee).
Level 3	✓ (Level 3 is available in all cases)
Level 4	Not applicable

2.14	CHANGING THE CONDITION OF THE BALL IN BREACH OF CLAUSE 41.3 OF THE ICC STANDARD TEST MATCH, ODI AND T20I PLAYING CONDITIONS.
Note:	<p>This offence supplements and does not replace ICC Standard Test Match, ODI and T20I Playing Conditions clause 41.3.</p> <p>Any action(s) likely to alter the condition of the ball which are not specifically permitted under clause 41.3.2 may be regarded as 'unfair'. The following actions shall, therefore, not be permitted (this list of actions is not exhaustive but included for illustrative purposes): (a) deliberately throwing the ball into the ground for the purpose of roughening it up; (b) applying any artificial substance to the ball; and applying any non-artificial substance for any purpose other than to polish the ball; (c) lifting or otherwise interfering with any of the seams of the ball; and (d) scratching the surface of the ball with finger or thumb nails or any implement.</p> <p>The Umpires shall use their judgment to apply the principle that actions taken to maintain or enhance the condition of the ball, provided no artificial substances are used, shall be permitted. Any actions taken with the purpose of damaging the condition of the ball or accelerating the deterioration of the condition of the ball shall not be permitted.</p>
Level 1	Not applicable
Level 2	Not applicable
Level 3	✓
Level 4	Not applicable

2.15	ATTEMPTING TO GAIN AN UNFAIR ADVANTAGE DURING AN INTERNATIONAL MATCH
Note:	<p>Article 2.15 is intended to cover any attempts to cheat or gain an unfair advantage during an International Match (other than conduct prohibited under Articles 2.11 or 2.14 of the Code of Conduct or the ICC's Anti-Corruption Code). It includes, without limitation: (a) deliberate attempts to deceive an Umpire (for example by claiming a catch when the Player concerned knew that he/she had not caught the ball cleanly); (b) any attempts by a Player on the field of play to seek assistance from any person off the field of play in order to decide whether to request a referral to the TV Umpire; or (c) taking a foreign object onto the field whose most likely reason for being there is to change the condition of the ball.</p> <p>When assessing the seriousness of the breach, consideration should be given to whether the conduct was deliberate, reckless and/or negligent on the part of the relevant Player or Player Support Personnel.</p>
Level 1	Not applicable
Level 2	Not applicable
Level 3	✓
Level 4	Not applicable

2.16	INTIMIDATION OF AN UMPIRE OR MATCH REFEREE WHETHER BY LANGUAGE OR CONDUCT (INCLUDING GESTURES) DURING AN INTERNATIONAL MATCH.
Note:	<p>Article 2.16 is intended to cover any form of intimidation of an Umpire or Match Referee. It includes, without limitation: (a) any form of continual verbal or physical harassment; (b) any form of intentional behavior that would cause the person at whom it is directed to fear injury or harm; and (c) attempts to impede or block movement.</p>
Level 1	Not applicable
Level 2	Not applicable
Level 3	✓
Level 4	Not applicable

2.17	THREAT OF ASSAULT ON ANOTHER PLAYER, PLAYER SUPPORT PERSONNEL, UMPIRE OR MATCH REFEREE OR ANY OTHER PERSON (INCLUDING A SPECTATOR) DURING AN INTERNATIONAL MATCH.
Note:	<p>Without limitation, Players or Player Support Personnel will breach this Article 2.17 if they do or say anything which would cause the Player, Player Support Personnel, Umpire, Match Referee or other person to whom such action was directed to fear harmful or offensive contact, for example and without limitation, threatening to hit the relevant individual while at the same time raising a fist, or threatening to physically harm another Player's family.</p>
Level 1	Not applicable
Level 2	Not applicable
Level 3	✓ (Level 3 is available in the case of threat of assault on anyone other than an Umpire or Match Referee)
Level 4	✓ (Level 4 is available in the case of threat of assault on Umpires and Match Referees only. Not available in the case of threat of assault on any Player, Player Support Personnel or other person)

2.18	PHYSICAL ASSAULT OF ANOTHER PLAYER, PLAYER SUPPORT PERSONNEL, UMPIRE, MATCH REFEREE OR ANY OTHER PERSON (INCLUDING A SPECTATOR) DURING AN INTERNATIONAL MATCH
Note:	Without limitation, Players or Player Support Personnel will breach this Article 2.18 if they intentionally or recklessly cause the Player, Player Support Personnel, Umpire, Match Referee or the other person bodily harm or injury.
Level 1	Not applicable
Level 2	Not applicable
Level 3	Not applicable
Level 4	✓

2.19	ANY ACT OF VIOLENCE ON THE FIELD OF PLAY DURING AN INTERNATIONAL MATCH
Note:	Without limitation, Players or Player Support Personnel will breach this Article 2.19 if they kick or punch or fight another Player, Player Support Personnel, Umpire, Match Referee or any other person (including a spectator).
Level 1	Not applicable
Level 2	Not applicable
Level 3	Not applicable
Level 4	✓

2.20	CONDUCT THAT IS CONTRARY TO THE SPIRIT OF THE GAME
Note:	<p>Article 2.20 is intended to cover all types of conduct that is contrary to the spirit of the game and which is not specifically and adequately covered by the specific offences set out elsewhere in this Code of Conduct.</p> <p>By way of example, Article 2.20 may (depending upon the seriousness and context of the breach) prohibit, without limitation, the following: (a) the use of an illegal bat or illegal wicket-keeping gloves; and (b) failure to comply with the provisions of clause 6.3 of the ICC Standard Test Match, ODI and T20I Playing Conditions.</p> <p>When assessing the seriousness of the offence, the context of the particular situation, and whether it was deliberate, reckless, negligent, avoidable and/or accidental, shall be considered. Further, the person lodging the Report shall determine where on the range of severity the conduct lays (with the range of severity starting at conduct of a minor nature (and hence a Level 1 offence) up to conduct of an extremely serious nature (and hence a Level 4 offence)).</p>
Level 1	✓
Level 2	✓
Level 3	✓
Level 4	✓

2.21	CONDUCT THAT BRINGS THE GAME INTO DISREPUTE
Note:	<p>Article 2.21 is intended to cover all types of conduct that bring the game into disrepute and which is not specifically and adequately covered by the specific offences set out elsewhere in this Code of Conduct, including Article 2.20.</p> <p>By way of example, Article 2.21 may (depending upon the seriousness and context of the breach) prohibit, without limitation, the following: (a) public acts of misconduct; (b) unruly public behaviour; and (c) inappropriate comments which are detrimental to the interests of the game.</p> <p>When assessing the seriousness of the offence, the context of the particular situation, and whether it was deliberate, reckless, negligent, avoidable and/or accidental, shall be considered. Further, the person lodging the Report shall determine where on the range of severity the conduct lays (with the range of severity starting at conduct of a minor nature (and hence a Level 1 offence) up to conduct of an extremely serious nature (and hence a Level 4 offence)).</p>
Level 1	✓
Level 2	✓
Level 3	✓
Level 4	✓

2.22 Minimum Over Rate Offences:

Failure by a fielding team participating in an International Match to meet the Minimum Over Rate requirements contained in Appendix 2 constitutes a **“Minimum Over Rate Offence”** under this Code of Conduct by each of the Players in that fielding team.

NOTE: Subjective intent on behalf of the fielding team, or any member thereof, to waste time is not required. It is sufficient to establish that the Minimum Over Rate was not met. To avoid liability under this offence the fielding team would need to establish, on the balance of probabilities, that the shortfall was due to factors beyond their control and that the time allowances permitted by the Match Officials in calculating the required over rate were not sufficient. The presence or absence of subjective intent and the extent of the shortfall shall be relevant in relation to the issue of penalty.

ARTICLE 3 – REPORTING AN ALLEGED OFFENCE UNDER THE CODE OF CONDUCT

NOTE: Where a Code of Conduct offence is alleged to have occurred during, or in relation to an ICC Event (whether on the field of play or otherwise), the Code of Conduct shall apply in full, but with a series of amendments to the reporting process (Article 3), disciplinary procedure (Article 5) and appeal process (Article 8) in order to ensure that any matters arising can be dealt with expediently. Such amendments are described in detail in Appendix 4.

Where a Minimum Over Rate Offence may have occurred, see Appendix 2 for the reporting process, disciplinary process and sanctions that are to be applied.

- 3.1 Any one of the following individuals can report an alleged offence under the Code of Conduct (other than Minimum Over Rate Offences - as to which see Appendix 2) by lodging a report in the manner described in Article 3.2, below (a **“Report”**):
 - 3.1.1 an Umpire that officiated in the International Match during which the alleged offence was committed;
 - 3.1.2 the CEO of either of the two National Cricket Federations whose representative teams participated in the International Match during, or in relation to which, the alleged offence was committed, or his/her designee (provided that the identity of such designee is advised to the ICC by the National Cricket Federation in advance of, or at least at the same time as, the Report is lodged);
 - 3.1.3 the ICC’s Chief Executive Officer; or
 - 3.1.4 provided it is a Level 4 Offence that is alleged to have been committed (or a Level 1 Offence, Level 2 Offence or Level 3 Offence in relation to which the Match Referee was the victim of the alleged offence), the Match Referee that was appointed to officiate in the International Match during which the alleged offence was committed. (For the avoidance of any doubt, the Match Referee is not entitled to lodge a Report in relation to an alleged Level 1 Offence, Level 2 Offence or Level 3 Offence unless he/she was the victim of the alleged offence).

- 3.2 All Reports must be completed on Form “Rep 1” (or such other form as may be made available for such purpose by the ICC from time to time). All Reports must be signed and dated by the person lodging the Report as follows:

3.2.1 Where the Report is lodged by an Umpire (pursuant to Article 3.1.1):

LEVEL OF OFFENCE	ON OR OFF-FIELD	REPORTING DEADLINE	REPORT LODGED WITH
Levels 1 & 2	On Field	24 hours from close of day’s play in the relevant International Match	Match Referee
	Off-Field	48 hours after: a) the commission of the alleged offence; or b) the alleged offence was brought to his/her attention, save that the Report cannot be lodged more than 7 days after the conclusion of the relevant International Match.	
Level 3	On or Off Field	48 hours after: a) the commission of the alleged offence; or b) the alleged offence was brought to his/her attention, save that the Report cannot be lodged more than 7 days after the conclusion of the relevant International Match.	
Level 4	On or Off Field	7 days after the conclusion of the relevant International Match	ICC’s General Counsel

3.2.2 Where the Report is lodged by the CEO of either of the two National Cricket Federations (pursuant to Article 3.1.2):

LEVEL OF OFFENCE	ON OR OFF-FIELD	REPORTING DEADLINE	REPORT LODGED WITH
Levels 1 & 2	On Field	48 hours from close of day's play in the relevant International Match	Match Referee
	Off-Field	96 hours after: a) the commission of the alleged offence; or b) the alleged offence was brought to his/her attention, save that the Report cannot be lodged more than 7 days after the conclusion of the relevant International Match.	
Level 3	On or Off Field	96 hours after: a) the commission of the alleged offence; or b) the alleged offence was brought to his/her attention, save that the Report cannot be lodged more than 7 days after the conclusion of the relevant International Match.	ICC's General Counsel
Level 4	On or Off Field	7 days after conclusion of the relevant International Match	

3.2.3 Where the Report is lodged by the ICC's Chief Executive Officer (pursuant to Article 3.1.3):

LEVEL OF OFFENCE	ON OR OFF-FIELD	REPORTING DEADLINE	REPORT LODGED WITH
Levels 1, 2 & 3	On or Off Field	7 days after the alleged offence is brought to his/her attention.	Match Referee
Level 4	On or Off Field	7 days after the alleged offence is brought to his/her attention.	ICC's General Counsel

3.2.4 Where the Report is lodged by the Match Referee (pursuant to Article 3.1.4):

LEVEL OF OFFENCE	ON OR OFF-FIELD	REPORTING DEADLINE	REPORT LODGED WITH
Levels 1, 2 & 3	On or Off Field	48 hours after: a) the commission of the alleged offence; or b) the alleged offence was brought to his/her attention, save that the Report cannot be lodged more than 7 days after the conclusion of the relevant International Match	ICC's General Counsel
Level 4	On or Off Field	7 days after conclusion of the relevant International Match	

Note: For the purposes of Articles 3.2.1 to 3.2.4 above, Reports should be lodged as soon as reasonably practicable. The time limits set out in the above tables constitute the latest time by which a Report can be lodged.

In all circumstances where a Report is to be lodged with the Match Referee if, for logistical reasons, it is impractical to lodge the Report with the Match Referee, it shall be lodged with the ICC's Cricket Operations Department within the same deadline.

3.3 Where it is alleged that a Player or Player Support Personnel has committed more than one offence under the Code of Conduct during, or in relation to an International Match or during, or in relation to an ICC Event (whether on the field of play or otherwise), whether arising out of the same set of facts or otherwise, then a separate Report should be filed in accordance with this Article 3 for each of the offences that are alleged to have been committed.

NOTE: For the avoidance of doubt, only one Report should be laid per offence. As such, where the incident in question could fall within more than one offence under Article 2, for example Article 2.7 (public criticism or inappropriate comment) and Article 2.21 (conduct that brings the game into disrepute) a Report should be laid only in respect of the offence which most specifically covers the relevant conduct (in the example above, Article 2.7) and not both offences.

ARTICLE 4 – NOTIFICATION PROCEDURE**Level 1 Offences, Level 2 Offences, Level 3 Offences
and Minimum Over Rate Offences:**

- 4.1 Where a Match Referee receives a Report lodged under Articles 3.2.1, 3.2.2, 3.2.3, or Article 3.2 of Appendix 2 (in the case of Minimum Over Rate Offences), he/she must review the Report and determine whether the Player or Player Support Personnel named in the Report has a case to answer in relation to the offence identified in the Report. Where the Match Referee determines that there is a case to answer, he/she must promptly provide a copy of the Report, together with a completed Form "Not 1", (such documents comprising the **'Notice of Charge'**), to the following individuals:
- 4.1.1 the Player or Player Support Personnel named in the Report, or, where appropriate in the case of an offence under either Article 2.11 (manipulating an International Match), 2.14 (changing the condition of the ball), or 2.22 (failure to meet the Minimum Over Rate), the relevant Team Captain; and
- 4.1.2 the Team Manager of the relevant Player or Player Support Personnel named in the Report.
- 4.2 Where the ICC's General Counsel receives a Report lodged under Article 3.2.4, he/she must review the Report and determine whether the Player or Player Support Personnel named in the Report has a case to answer in relation to the offence identified in the Report. Where the ICC's General Counsel determines that there is a case to answer, he/she must promptly provide a copy of the Report, together with a completed Form "Not 1" (such documents comprising the **'Notice of Charge'**), to the following individuals:
- 4.2.1 the Player or Player Support Personnel named in the Report, or, where appropriate in the case of an offence under either Article 2.11 (manipulating an International Match), 2.14 (changing the condition of the ball), or 2.22 (failure to meet the Minimum Over Rate), the relevant Team Captain; and
- 4.2.2 the Team Manager of the relevant Player or Player Support Personnel named in the Report.
- 4.3 The Notice of Charge shall specify that the Player or Player Support Personnel shall have the following three options:
- 4.3.1 he/she may admit the offence charged and accede to the proposed sanction specified in the Notice of Charge (which sanction shall be strictly at the Match Referee's discretion, but at all times within the appropriate range for the level of offence). In such circumstances, and provided that such admission has been received by the Match Referee prior to the commencement of the hearing at the time/place specified in the Notice of Charge, the hearing before the Match Referee shall not be required and no further action shall be taken, save that the ICC shall promptly issue a public statement confirming: (a) the commission of an offence under the Code of Conduct; and (b) the imposition of the applicable sanction specified in the Notice of Charge; or

4.3.2 he/she may admit the offence charged but dispute the proposed sanction specified in the Notice of Charge, in which case the matter shall proceed to a hearing in accordance with Article 5.1; or

4.3.3 he/she may deny the offence charged, in which case the matter shall proceed to a hearing in accordance with Article 5.1.

Level 4 Offences:

- 4.4 Where the ICC's General Counsel receives a Report lodged under Articles 3.2.1, 3.2.2, 3.2.3 or 3.2.4, he/she must promptly conduct a review to determine whether the Player or Player Support Personnel named in the Report has a case to answer in relation to the specific type and/or level of offence identified in the Report (i.e. to determine, in the ICC's opinion, whether the specific type and level of offence noted in the Report is properly identified when reviewed against the conduct complained of).
- 4.5 If the initial review of the Report reveals that there is no case to answer in relation to the specific type and/or level of offence, then the ICC shall notify the person who filed the Report of that fact, advising them of the reasons that such a determination has been made and, where applicable, providing guidance on which specific type and level of offence the ICC considers to be appropriate. Upon receipt of such a decision, the person who filed the Report shall, notwithstanding the provisions of Article 3.2 and having considered the ICC's guidance in good faith, within a period of twenty-four (24) hours from the time of notification by the ICC, notify the ICC whether he/she wishes to: (a) revise the specific type and/or level of the offence charged, in which case a revised Report must be lodged with the ICC within such twenty-four (24) period; (b) proceed on the basis of the original Report lodged; or (c) withdraw the Report.
- 4.6 If the initial review of the Report reveals that there is a case to answer, or a revised Report is lodged with the ICC pursuant to Article 4.5, then the ICC shall promptly provide a copy of the Report, together with a completed Form "Not 1" (such documents comprising the **'Notice of Charge'**) to the following individuals:
- 4.6.1 the Player or Player Support Personnel named in the Report; and
- 4.6.2 the Team Manager of the relevant Player or Player Support Personnel named in the Report; and
- 4.6.3 the CEO of the National Cricket Federation to which the relevant Player or Player Support Personnel is affiliated.
- 4.7 The Notice of Charge shall specify that the Player or Player Support Personnel shall have the following options:
- 4.7.1 he/she may admit the offence charged and accede to the proposed sanction specified in the Notice of Charge (which sanction shall be strictly at the ICC's discretion, but at all times within the appropriate range for the level of offence). In such circumstances, and provided that such admission has been received by the ICC's General Counsel prior to the commencement of the hearing at the time/place specified in the Notice of Charge, the hearing before the Judicial Commissioner shall not be required and no further action shall be taken, save that the ICC shall promptly issue a public statement confirming: (a) the commission of an offence under the Code of Conduct; and (b) the imposition of the applicable sanction specified in the Notice of Charge; or

- 4.7.2 he/she may admit the offence charged but dispute the proposed sanction specified in the Notice of Charge, in which case the matter shall proceed to a hearing in accordance with Article 5.2; or
- 4.7.3 he/she may deny the offence charged, in which case the matter shall proceed to a hearing in accordance with Article 5.2.

ARTICLE 5 – THE DISCIPLINARY PROCEDURE

NOTE: Where a Match Referee appointed to adjudicate any matter brought under this Code of Conduct is not physically present at the relevant International Match (and therefore required to perform his/her duties remotely) or his/her appointment to that series of International Matches has ended and thus he/she is no longer in the same location at the teams, then all hearings arising under Article 5.1 will be held by telephone conference or video conference (if available) and the provisions of Article 5.1 are to be interpreted accordingly.

Level 1 Offences, Level 2 Offences, Level 3 Offences and Minimum Over Rate Offences:

- 5.1 Where a matter proceeds to a hearing under Article 4.3.2 or 4.3.3, then, subject to Article 5.7 below, the case shall be referred to the Match Referee for adjudication in accordance with the following procedure:
- 5.1.1 In the case of Level 1 Offences, Level 2 Offences, Level 3 Offences or Minimum Over Rate Offences, subject to the discretion of the Match Referee to order otherwise for good cause shown by the Player or Player Support Personnel, the hearing will take place at the time specified in the Notice of Charge (which should take place as soon as practicable and, in the absence of exceptional circumstances, no more than thirty-six (36) hours after the receipt by the Player or Player Support Personnel of the Notice of Charge) and, subject to the note to Article 5, in the country in which the alleged offence was committed. For the avoidance of doubt, nothing in this Article 5.1.1 prevents a hearing from being convened at a time during which the International Match in relation to which the alleged offence took place, remains in progress.
- 5.1.2 The procedure followed at the hearing shall be at the discretion of the Match Referee, provided that the hearing is conducted in a manner which offers the Player or Player Support Personnel a fair and reasonable opportunity to present evidence (including the right to call and to question witnesses by telephone or video-conference where necessary), address the Match Referee and present his/her case.
- 5.1.3 The hearing before the Match Referee shall be in English, and certified English translations shall be submitted of any non-English documents put before the Match Referee. The cost of the translation shall be borne by the party offering the document(s).
- 5.1.4 Where video evidence of the alleged offence is available at the hearing before the Match Referee, then it may be relied upon by any party, provided that all other parties shall have the right to make such representations in relation to it that they may see fit.
- 5.1.5 Unless exceptional circumstances apply, each of the following individuals must attend any hearing before the Match Referee: (a) the Player or Player Support Personnel who has been charged with the alleged offence; and (b) the person who lodged the Report (or, in the case of the ICC's Chief Executive Officer, his/her representative/nominee). Where any such individual has a compelling justification for his/her non-attendance, then they shall be given the opportunity to participate in the hearing before the Match Referee by telephone or video conference (if available). Without prejudice to the Player or Player Support Personnel's ability to call and to question such witnesses as may be necessary and/or to be represented by such other person of his/her own choosing pursuant to Article 5.1.6, one of the Team Captain, Team Vice-Captain or Team Manager of the team that the Player or Player Support Personnel represents may also attend such a hearing to provide additional support and assistance to the Player or Player Support Personnel.
- 5.1.6 Each of the individuals described in Article 5.1.5(a) and (b) shall have the right (at his/her or its own expense) to be represented at the hearing before the Match Referee by such representative (including legal counsel) of his/her or its own choosing. Where the person lodging the Report is an Umpire that officiated in the International Match in question or the ICC's Chief Executive Officer, then such person shall be entitled to be represented prior to, and during, the hearing (if he/she considers necessary) by a representative of the ICC's Legal Department.
- 5.1.7 The non-attendance of any Player or Player Support Personnel or his/her representative at the hearing, shall not prevent the Match Referee from proceeding with the hearing in his/her absence and issuing a ruling in relation to the offence charged.
- 5.1.8 At the end of a hearing, where the Match Referee considers that further evidence is necessary or further time is required to consider the evidence that has been presented, he/she shall adjourn the hearing for an appropriate period of time and make such directions as may be necessary.
- 5.1.9 Alternatively, at the end of a hearing:
- 5.1.9.1 brought under Article 4.3.2:
- (a) as soon as possible after the conclusion of the hearing (and, in any event, no later than twenty-four (24) hours thereafter), the Match Referee will confirm the Player or Player Support Personnel's admission that he/she had committed a Code of Conduct offence and announce the substance of his/her decision. Within five (5) days after the conclusion of the hearing, the Match Referee shall issue his/her written decision, with reasons, setting out: (a) what sanctions, if any, are to be imposed (including any fine and/or period of suspension); (b) the date that any period of suspension shall come into force and effect; and (c) any rights of appeal that may exist pursuant to Article 8.

- 5.1.9.2 brought under Article 4.3.3 (or where the Player or Player Support Personnel has failed to respond in a timely fashion to the Notice of Charge):
- (a) the Match Referee shall adjourn the hearing (for a period of no less than ten (10) minutes and no more than twenty-four (24) hours), following which he/she will reconvene the hearing and verbally announce his/her finding as to whether a Code of Conduct offence has been committed;
 - (b) where the Match Referee determines that a Code of Conduct offence has been committed, the Player or Player Support Personnel may request a short adjournment (of no more than thirty (30) minutes) to prepare any submissions that he/she might wish to make in relation to the appropriate sanction that ought to be applied; and
 - (c) as soon as possible after the conclusion of the hearing (and, in any event, no later than twenty-four (24) hours thereafter), the Match Referee will announce the substance of his/her decision. Within five (5) days after the conclusion of the hearing, the Match Referee shall issue his/her written decision, with reasons, setting out: (a) the finding as to whether a Code of Conduct offence had been committed; (b) what sanctions, if any, are to be imposed (including any fine and/or period of suspension); (c) the date that any period of suspension shall come into force and effect; and (d) any rights of appeal that may exist pursuant to Article 8.
- 5.1.10 A copy of the written reasoned decision will be provided to the Player or Player Support Personnel, the CEO of the Player or Player Support Personnel's National Cricket Federation, and the ICC's Cricket Operations Manager.
- 5.1.11 Subject only to the rights of appeal under Article 8, the Match Referee's decision shall be the full, final and complete disposition of the matter and will be binding on all parties.

Level 4 Offences:

- 5.2 Where a matter proceeds to a hearing under Article 4.7.2 or 4.7.3, then the case shall be referred to a Judicial Commissioner for adjudication in accordance with the following procedure:
- 5.2.1 As soon as reasonably possible, the ICC shall appoint one member from the ICC's Code of Conduct Commission to sit as the Judicial Commissioner to hear the case sitting alone. The appointed member shall be independent of the parties, have had no prior involvement with the case and shall not, unless otherwise agreed between the parties, be from a country participating in the International Match, during, or in relation to which, the alleged offence was committed.

- 5.2.2 The Judicial Commissioner shall convene a preliminary hearing with the individual lodging the Report pursuant to Article 3.1 (the **Complainant**) and his/her legal representatives (if any), together with the Player or Player Support Personnel and his/her legal representatives (if any). The preliminary hearing should take place as soon as possible by telephone conference call unless the Judicial Commissioner determines otherwise. The non-participation, without compelling justification, of the Player or Player Support Personnel or his/her representative at the preliminary hearing, after proper notice of the preliminary hearing has been provided, shall not prevent the Judicial Commissioner from proceeding with the preliminary hearing, whether or not any written submissions are made on behalf of the Player or Player Support Personnel. Where the initial Report was lodged by someone other than the individual described in Article 3.1.3, the ICC will be notified and invited to participate in any such preliminary hearing convened by the Judicial Commissioner through its representative.
- 5.2.3 The purpose of the preliminary hearing shall be to allow the Judicial Commissioner to address any preliminary issues that need to be resolved prior to the hearing date. In particular (but without limitation), the Judicial Commissioner shall:
- 5.2.3.1 determine the date(s) upon which the full hearing shall be held. Save in exceptional circumstances or where the parties otherwise agree, the full hearing should take place no longer than fourteen (14) days after the receipt by the Player or Player Support Personnel of the Notice of Charge.
 - 5.2.3.2 establish dates reasonably in advance of the date of the full hearing by which:
 - (a) the Complainant shall submit an opening brief with argument on all issues that the Complainant wishes to raise at the hearing and a list of the witnesses that the Complainant intends to call at the hearing (and a summary of the subject areas of the witness's anticipated testimony), and enclosing copies of the exhibits that the Complainant intends to introduce at the hearing;
 - (b) the Player or Player Support Personnel shall submit an answering brief, addressing the Complainant's arguments and setting out argument on the issues that he/she wishes to raise at the hearing, as well as a list of the witnesses that he/she intends to call at the hearing (and a summary of the subject areas of the witness's anticipated testimony), and enclosing copies of the exhibits that he/she intends to introduce at the hearing; and
 - (c) the Complainant may (at its discretion) submit a reply brief, responding to the answer brief of the Player or Player Support Personnel and listing any rebuttal witnesses that the Complainant intends to call at the hearing (and a summary of the subject areas of the witness's anticipated testimony), and enclosing copies of any other exhibits that the Complainant intends to introduce at the hearing; and

- 5.2.3.3 make such order as the Judicial Commissioner shall deem appropriate in relation to the production of relevant documents and/or other materials between the parties.
- 5.2.4 Subject to the discretion of the Judicial Commissioner to order otherwise for good cause shown by either party, or if otherwise agreed between the parties, hearings before the Judicial Commissioner shall take place in the country in which the alleged offence was committed.
- 5.2.5 The procedure followed at the hearing shall be at the discretion of the Judicial Commissioner, provided that the hearing is conducted in a manner which offers the Player or Player Support Personnel a fair and reasonable opportunity to present evidence (including the right to call and to question witnesses by telephone or video-conference where necessary), address the Judicial Commissioner and present his/her case.
- 5.2.6 The hearing before the Judicial Commissioner shall be in English, and certified English translations shall be submitted of any non-English documents put before the Judicial Commissioner. The cost of the translation shall be borne by the party offering the document(s). If required by the Judicial Commissioner (at his/her discretion), the ICC shall make arrangements to have the hearing recorded or transcribed. If requested by the Player or Player Support Personnel, the ICC shall also arrange for an interpreter to attend the hearing. Such costs of transcription and interpretation shall be paid by the ICC.
- 5.2.7 Where video evidence of the alleged offence is available at the hearing before the Judicial Commissioner, then it may be relied upon by any party, provided that all other parties shall have the right to make such representations in relation to it that they may see fit.
- 5.2.8 Unless exceptional circumstances apply, each of the following individuals must attend any hearing before the Judicial Commissioner: (a) the Player or Player Support Personnel who has been charged with the alleged offence; and (b) the Complainant (or, in the case of the ICC's Chief Executive Officer, his/her representative/nominee). Where any such individual has a compelling justification for his/her non-attendance, then they shall be given the opportunity to participate in the hearing before the Judicial Commissioner by telephone or video conference (if available). In addition, a representative of the ICC's legal department shall be entitled to attend any such hearing. Without prejudice to the Player or Player Support Personnel's ability to call and to question such witnesses as may be necessary and/or to be represented by such other person of his/her own choosing pursuant to Article 5.2.9, one of the Team Captain, Team Vice-Captain or Team Manager of the team that the Player or Player Support Personnel represents may also attend such hearing to provide additional support and assistance to the Player or Player Support Personnel.

- 5.2.9 Each of the individuals described in Article 5.2.8(a) and (b) shall have the right (at his/her or its own expense) to be represented at the hearing before the Judicial Commissioner by such representative (including legal counsel) of his/her or its own choosing. Where the Complainant is an Umpire or Match Referee that officiated in the International Match in question or the ICC's Chief Executive Officer, then such person shall be entitled to be represented prior to, and during, the hearing (if he/she considers necessary) by a representative of the ICC's Legal Department.
- 5.2.10 The non-attendance of the Player or Player Support Personnel or his/her representative at the hearing, after proper notice of the hearing has been provided, shall not prevent the Judicial Commissioner from proceeding with the hearing in his/her absence, whether or not any written submissions are made on his/her behalf.
- 5.2.11 At the end of a hearing, where the Judicial Commissioner considers that further evidence is necessary or further time is required to consider the evidence that has been presented, he/she shall adjourn the hearing for an appropriate period of time and make such directions as may be necessary.
- 5.2.12 Alternatively, at the end of a hearing:
- 5.2.12.1 brought under Article 4.7.2:
- (a) as soon as possible after the conclusion of the hearing (and, in any event, no later than forty-eight (48) hours thereafter), the Judicial Commissioner will confirm the Player or Player Support Personnel's admission that he/she had committed a Code of Conduct offence and announce the substance of his/her decision. Within seven (7) days after conclusion of the hearing, the Judicial Commissioner shall announce his/her written decision, with reasons, setting out: (a) what sanctions, if any, are to be imposed (including any fine and/or period of suspension); (b) the date that any period of suspension shall come into force and effect; and (c) any rights of appeal that may exist pursuant to Article 8.
- 5.2.12.2 brought under Article 4.7.3 (or where the Player or Player Support Personnel has failed to respond in a timely fashion to the Notice of Charge):
- (a) the Judicial Commissioner shall adjourn the hearing (for a period of no less than ten (10) minutes and no more than twenty-four (24) hours), following which he/she will reconvene the hearing and verbally announce his/her finding as to whether a Code of Conduct offence has been committed;
- (b) where the Judicial Commissioner determines that a Code of Conduct offence has been committed, the Player or Player Support Personnel may request a short adjournment (of no more than thirty (30) minutes) to prepare any submissions that he/she might wish to make in relation to the appropriate sanction that ought to be applied; and

- (c) as soon as possible after the conclusion of the hearing (and, in any event, no later than forty-eight (48) hours thereafter), the Judicial Commissioner will announce the substance of his/her decision. Within seven (7) days after conclusion of the hearing, the Judicial Commissioner shall announce his/her written decision, with reasons, setting out: (a) the finding as to whether a Code of Conduct offence had been committed; (b) what sanctions, if any, are to be imposed (including any fine and/or period of suspension); (c) the date that any period of suspension shall come into force and effect; and (d) any rights of appeal that may exist pursuant to Article 8.

- 5.2.13 A copy of the written reasoned decision will be provided to the Player or Player Support Personnel, the CEO of the Player or Player Support Personnel's National Cricket Federation, the Complainant and the ICC's Cricket Operations Manager.
- 5.2.14 Subject only to the rights of appeal under Article 8, the Judicial Commissioner's decision shall be the full, final and complete disposition of the matter and will be binding on all parties.

General Principles of Procedure

- 5.3 Where a Report is filed by more than one of the individuals described in Article 3.1 in relation to the same alleged offence under the Code of Conduct, then the Player or Player Support Personnel alleged to have committed the offence will only be served with one Notice of Charge in accordance with the procedures set out in Article 4. However, all persons who filed a Report (or, in the case of the ICC's Chief Executive Officer, his/her representative/nominee) in relation to the alleged offence are required to attend the hearing before the Match Referee or Judicial Commissioner unless there is a compelling justification for his/her non-attendance, in which case they shall be given the opportunity to participate in the hearing by telephone or video conference (if available).
- 5.4 Where two or more Players or Player Support Personnel are alleged to have committed offences under the Code of Conduct, they may both be dealt with at the same hearing where the proceedings arise out of the same incident or set of facts, or where there is a clear link between separate incidents, as follows:
- 5.4.1 any number of Level 1 Offences and/or Level 2 Offences and/or Level 3 Offences can all be determined by a Match Referee at the same hearing; and
- 5.4.2 any number of Level 4 Offences can all be determined by a Judicial Commissioner at the same hearing; and
- 5.4.3 a Level 1 Offence and/or Level 2 Offence and/or Level 3 Offence can be determined by a Judicial Commissioner at the same hearing as a Level 4 Offence; but
- 5.4.3 a Level 4 Offence cannot be determined by a Match Referee at the same hearing as a Level 1 Offence or a Level 2 Offence or a Level 3 Offence, and separate proceedings should therefore be issued in relation to each alleged offence.

- 5.5 Where a Player or Player Support Personnel is alleged to have committed more than one breach of the Code of Conduct during, or in relation to the same International Match, then all of the alleged offences may be dealt with at the same hearing, as follows:
- 5.5.1 any number of Level 1 Offences and/or Level 2 Offences and/or Level 3 Offences can all be determined by a Match Referee at the same hearing; and
- 5.5.2 any number of Level 4 Offences can all be determined by a Judicial Commissioner at the same hearing; and
- 5.5.3 a Level 1 Offence and/or Level 2 Offence and/or Level 3 Offence can be determined by a Judicial Commissioner at the same hearing as a Level 4 Offence; but
- 5.5.3 a Level 4 Offence cannot be determined by a Match Referee at the same hearing as a Level 1 Offence or a Level 2 Offence or a Level 3 Offence, and separate proceedings should therefore be issued in relation to each alleged offence.
- 5.6 Any failure or refusal by any Player or Player Support Personnel to provide assistance to a Match Referee or Judicial Commissioner in connection with any charge made pursuant to this Code of Conduct may constitute a separate offence (depending upon the seriousness and context of such failure or refusal) under Article 2.20 of the Code of Conduct.
- 5.7 Where a Match Referee lodges a Report with the ICC's General Counsel pursuant to Article 3.2, and, pursuant to Article 4.2, the ICC's General Counsel determines that there is a case to answer, he/she shall appoint a member of the ICC's Code of Conduct Commission (who shall have had no prior involvement with the case and shall not, unless otherwise agreed between the parties, be from a country participating in the International Match during, or in relation to which, the alleged offence was committed) to hear the case as a replacement to the Match Referee and all of the remaining procedure will apply accordingly.
- 5.8 In addition to, and notwithstanding, Article 5.7 above, where a Match Referee is, or becomes, unwilling or unable to hear a case (for example, where he/she finds him/herself in a position of conflict), then the ICC's General Counsel shall have the discretion to appoint the ICC's Chief Referee or such other referee as the ICC deems to be appropriate in all the circumstances. Where the ICC's Chief Referee (or such other referee) is unwilling or unable to hear the case, a member of the ICC's Code of Conduct Commission (who shall have had no prior involvement with the case and shall not, unless otherwise agreed between the parties, be from a country participating in the International Match during, or in relation to which, the alleged offence was committed) as a replacement to the Match Referee and all of the remaining procedure will apply accordingly.
- 5.9 Where a Judicial Commissioner is, or becomes unwilling or unable to hear a case (for example, where he/she finds him/herself in a position of conflict), then the ICC's General Counsel shall have the discretion to appoint another member of the ICC's Code of Conduct Commission (who shall have had no prior involvement with the case and shall not, unless otherwise agreed between the parties, be from a country participating in the International Match during, or in relation to which, the alleged offence was committed) as a replacement to the Judicial Commissioner and all of the remaining procedure will apply accordingly.

5.10 The ICC will issue a public announcement regarding any decision of the Match Referee or Judicial Commissioner made under the Code of Conduct, as soon as is reasonably practicable after the decision has been communicated to the parties. The public announcement of the decision may include details of the offences committed under the Code of Conduct and of the sanctions imposed, if any. Until such time as a public announcement is published, all parties and participants in the proceedings shall treat such proceedings as strictly confidential. For the avoidance of doubt, nothing in this Article shall prevent any party (or any relevant National Cricket Federation) publicly confirming the date of the hearing, the offence that is alleged to have been committed and/or the name of the Player or Player Support Personnel charged.

ARTICLE 6 – STANDARD OF PROOF AND EVIDENCE

- 6.1 Unless otherwise described herein, the standard of proof in all cases brought under the Code of Conduct shall be whether the Match Referee or Judicial Commissioner is comfortably satisfied, bearing in mind the seriousness of the allegation that is made, that the alleged offence has been committed. This standard of proof in all cases shall be determined on a sliding scale from, at a minimum, a mere balance of probability (for the least serious offences) up to proof beyond a reasonable doubt (for the most serious offences).
- 6.2 The Match Referee or Judicial Commissioner shall not be bound by judicial rules governing the admissibility of evidence. Instead, facts relating to an offence committed under the Code of Conduct may be established by any reliable means, including admissions.
- 6.3 The Match Referee or Judicial Commissioner may draw an inference adverse to the Player or Player Support Personnel who is asserted to have committed an offence under the Code of Conduct based on his/her refusal, without compelling justification, after a request made in a reasonable time in advance of the hearing, to appear at the hearing (either in person or telephonically as directed by the Match Referee or Judicial Commissioner) and/or to answer any relevant questions.

ARTICLE 7 – SANCTIONS ON PLAYERS AND PLAYER SUPPORT PERSONNEL

COMMENT: The aim of the sanctioning regime under this Code of Conduct is to (a) sanction those Players and Player Support Personnel found to have committed an offence under the Code of Conduct, and (b) to act as a deterrent to other Players and Player Support Personnel to deter them from conducting themselves improperly on and off the “field of play”. The ICC believes that the threat of a suspension is the strongest deterrent to bring about a change in behavior, hence the system of accumulated Demerit Points which is included in the Code of Conduct.

7.1 Where a Match Referee or Judicial Commissioner determines that an offence under the Code of Conduct has been committed, he/she will be required to impose an appropriate sanction on the Player or Player Support Personnel.

- 7.2 In determining the appropriate sanction, the Match Referee or Judicial Commissioner shall take into account any factors that he/she deems relevant and appropriate to the mitigation or aggravation of the nature of the Code of Conduct offence before determining, in accordance with the table set out in Article 7.3 below, what the appropriate sanction(s) should be.
- 7.3 In addition to sanctions imposed by a Match Referee or Judicial Commissioner under Article 7.2 above, Demerit Points will be imposed upon a Player or Player Support Personnel found to have committed an offence under the Code of Conduct. The number of Demerit Points imposed will be calculated by reference to the sanction imposed for the particular offences, as set out in the following table.

LEVEL OF OFFENCE	RANGE OF PERMISSIBLE SANCTIONS	CORRESPONDING DEMERIT POINTS	
Level 1	Warning and/or the imposition of a fine of up to 50% of the applicable Match Fee.	Warning or 0-25% fine	1
		26-50% fine	2
Level 2	The imposition of a fine of between 50-100% of the applicable Match Fee or up to two (2) Suspension Points.	50-100% fine or 1 Suspension Point	3
		2 Suspension Points	4
Level 3	The imposition of between four (4) and twelve (12) Suspension Points.*	4-7 Suspension Points	5
		8-12 Suspension Points	6
Level 4	The imposition of twelve (12) Suspension Points or a suspension for a fixed period of time ranging between, at a minimum, the lesser of the equivalent of twelve (12) Suspension Points and one (1) year, up to a maximum of a lifetime’s suspension.	12 Suspension Points	7
		Fixed period of suspension between 12 Suspension Points or one (1) year, and a lifetime suspension	8
Minimum Over Rate Offences	See specific sanctions described in the table at Article 4 of Appendix 2.	N/A	

Demerit Points will remain on a Player or Player Support Personnel’s disciplinary record for a period of twenty-four (24) months from their imposition following which they shall be immediately expunged.

***NOTE:** In all cases marked with a *, the maximum ‘actual’ period of suspension shall be no more than one (1) year, irrespective of the number and/or the practical application of any Suspension Points that might be imposed.

- 7.4 Where a Match Referee or Judicial Commissioner imposes a period of suspension on any Player or Player Support Personnel, then, unless such period is for a fixed period of time (for example, one year) then, any such period of suspension shall be referenced by Suspension Points, which shall carry the following weightings:
- 7.4.1 a Test Match or any other International Match of at least four days in duration is given a weighting of two (2) Suspension Points;
 - 7.4.2 a One Day International Match or Twenty20 International Match is given a weighting of one (1) Suspension Point; and
 - 7.4.3 all other International Matches are given a weighting of one (1) Suspension Point.
- 7.5 Each time a Player or Player Support Personnel is found to have committed an offence under the Code of Conduct and a sanction is imposed by a Match Referee or Judicial Commissioner, corresponding Demerit Points as per the table in Article 7.3 above shall be added to the Player or Player Support Personnel’s record and accumulated with any existing Demerit Points imposed on the Player or Player Support Personnel within the previous twenty-four (24) months. The ICC’s Cricket Operations Department will keep an accurate and up-to-date record of all Demerit Points imposed upon Players and Player Support Personnel and will carry out the process of accumulating Demerit Points each time a Player or Player Support Personnel is found to have committed an offence and sanctioned.
- 7.6 Where a Player or Player Support Personnel accumulates a total of four or more Demerit Points as set out in the table below, these Demerit Points shall be converted into Suspension Points (at the point that the Player or Player Support Personnel first crosses the relevant threshold) as follows:

ACCUMULATED DEMERIT POINTS	CORRESPONDING SUSPENSION POINTS
4-7	2
8-11	4
12-15	6
16 and above	8

- 7.7 Notice of the amount of Demerit Points imposed and the accumulated total, together with any resulting Suspension Points, will be communicated by the ICC’s Cricket Operations Department, as soon as is reasonably practicable, to the Player or Player Support Personnel at the same time as notice is provided to the CEO of the Player or Player Support Personnel’s National Cricket Federation of the commission of the offence and resulting sanction. Any resulting Suspension Points imposed on the basis of accumulated Demerit Points shall be applied in accordance with the principles set down in Article 7.9 below and shall take effect immediately upon notice of the same to the Player or Player Support Personnel.

- 7.8 Any Suspension Points imposed on a Player or Player Support Personnel through the accumulation of Demerit Points will be applicable in addition to, and, for the avoidance of doubt, not in place of, any Suspension Points or period of suspension imposed by the Match Referee or Judicial Commissioner pursuant to Article 7.2 above. However, any such period of suspension shall run concurrently with any period of suspension imposed by the Match Referee or Judicial Commissioner.

EXAMPLE OF THE APPLICATION OF DEMERIT POINTS:

1. A Player commits a Level 1 offence and receives a fine of 50% from the Match Referee.
2. That Player will correspondingly receive two (2) Demerit Points in respect of that offence on his/her disciplinary record.
3. The same Player then commits a Level 2 offence three (3) months after the Level 1 offence was committed and is sanctioned with 2 Suspension Points by the Match Referee.
4. The Level 2 offence will equate to four (4) Demerit Points.
5. As the second offence took place within three (3) months of the first offence, the Demerit Points imposed in respect of the second offence are added to the Demerit Points imposed in respect of the first offence, meaning that the Player now has an accumulated total of six (6) Demerit Points.
6. Six (6) Demerit Points equate to a suspension equivalent to two (2) Suspension Points (i.e. 1 Test Match or 2 ODIs or 2 T20Is. Such suspension will be served by the Player concurrently with the suspension imposed in respect of the Level 2 offence.
7. After completing his/her suspension, the Demerit Points remain on the Player’s disciplinary record for a period of twenty-four (24) months.
8. Three (3) months later, the Player commits another Level 2 offence and is sanctioned for that offence with a 100% fine.
9. A further three (3) Demerit Points will then be added to the Player’s disciplinary record in respect of that offence, taking his/her accumulated total within twenty-four (24) months to nine (9) Demerit Points.
10. Nine (9) Demerit Points equate to a suspension equivalent to four (4) Suspension Points (i.e. 2 Test Matches, 1 Test Match and 2 ODIs/T20Is or 4 ODIs or 4 T20Is). Such suspension will be served by the Player immediately upon notice of the same in accordance with Article 7.7.
11. After completing his/her suspension, the Demerit Points remain on the Player’s disciplinary record for a period of twenty-four (24) months.

- 7.9 Where Suspension Points are imposed against a Player or Player Support Personnel (whether by a Match Referee or Judicial Commissioner, or through the accumulation of Demerit Points in accordance with Article 7.6 above), then such Suspension Points will be applied in accordance with the following principles:
- 7.9.1 the Match Referee, Judicial Commissioner or the ICC (as applicable) shall have regard to the Player's or Player Support Personnel's participation in the various formats of International Matches over the previous two years in order to determine (to the best of his/her ability) which of the forthcoming International Matches the Player is most likely to participate in or the Player Support Personnel is most likely to assist the participation of a Player in;
- 7.9.2 where necessary, the Match Referee or Judicial Commissioner shall be entitled to consult with the ICC in order to make a determination as to which of the forthcoming International Matches the Player is most likely to participate in or the Player Support Personnel is most likely to assist the participation of a Player in;
- 7.9.3 in so far as is reasonably possible, the Match Referee, Judicial Commissioner or the ICC (as applicable) shall apply the Suspension Points to the subsequent International Matches in which the Player is most likely to participate in or the Player Support Personnel is most likely to assist the participation of a Player in, on a chronological basis immediately following the announcement of the decision;
- 7.9.4 where a Player or Player Support Personnel has his/her Suspension Points applied to an International Match that is subsequently cancelled, postponed or otherwise abandoned prior to the actual day on which it is scheduled to take place, then such Suspension Points must be reallocated to the next subsequent International Matches in which the Player is most likely to participate in or the Player Support Personnel is most likely to assist the participation of a Player in. Where an International Match is cancelled, postponed or otherwise abandoned at any time on the actual day on which it is scheduled to take place, then the Suspension Points will remain allocated to that International Match, irrespective of such cancellation, postponement or abandonment.

EXAMPLES OF THE APPLICATION OF SUSPENSION POINTS:

- 1 Where a Player's playing history suggests that he/she is most likely to represent his/her National Cricket Federation in Test Matches only, then the Suspension Points shall be applied to his/her future participation in Test Matches only, so that six (6) Suspension Points would be applied to the three (3) Test Matches immediately following the announcement of the decision, notwithstanding that the National Cricket Federation might be participating in intervening One Day International Matches and/or Twenty20 International Matches.
- 2 Where a Player's playing history suggests that he/she is likely to be selected to represent his/her National Cricket Federation in all formats of International Matches, then the Suspension Points shall be applied to his/her future participation in all International Matches in the sequential order in which such International Matches take place immediately following the announcement of the decision. The examples set out below, would apply to the following chronological list of potential playing fixtures:
 - Code of Conduct decision
 - One-Day International Match - weighting 1 Suspension Point ("Match A")
 - One-Day International Match - weighting 1 Suspension Point ("Match B")
 - Test Match - weighting 2 Suspension Point ("Match C")
 - Test Match weighting 2 Suspension Point ("Match D")
 - Twenty20 International Match - weighting 1 Suspension Point ("Match E")
 - Twenty20 International Match - weighting 1 Suspension Point ("Match F")
 - a) One (1) Suspension Point would be applied to Match A;
 - b) Two (2) Suspension Points would be applied to Matches A and B;
 - c) Three (3) Suspension Points would be applied to Matches A, B and E;
 - d) Four (4) Suspension Point would be applied to Match A, B and C;
 - e) Five (5) Suspension Points would be applied to Matches A, B, C and E;
 - f) Six (6) Suspension Points would be applied to Matches A, B, C and D;
 - g) Seven (7) Suspension Points would be applied to Matches A, B, C, D and E;
 - h) Eight (8) Suspension Points would be applied to Matches A, B, C, D, E and F.

7.10 For the avoidance of any doubt:

- 7.10.1 the Match Referee or Judicial Commissioner will have no jurisdiction to adjust, reverse or amend the results of any International Match;
- 7.10.2 where a Player or Player Support Personnel is found guilty of committing two separate Code of Conduct offences that do not relate to the same incident or set of circumstances arising during an International Match and sanctioned separately for each offence, then any sanctions should run cumulatively (and not concurrently);
- 7.10.3 where a Player or Player Support Personnel is found guilty of committing two Code of Conduct offences in relation to the same incident or set of circumstances arising during an International Match and sanctioned separately, then any sanctions imposed should run concurrently (and not cumulatively);
- 7.10.4 nothing in this Code of Conduct shall permit plea bargaining in relation to any alleged offence committed under this Code of Conduct;
- 7.10.5 where the Match Referee or Judicial Commissioner finds a Player or Player Support Personnel not guilty of the offence allegedly committed under the Code of Conduct, then it remains open to him/her, at his/her discretion, to find the Player or Player Support Personnel guilty of an offence of a lower level than that with which he/she has been charged. For example where a Player or Player Support Personnel has been charged with (but been found not guilty of) 'showing dissent at an Umpire's decision' (Article 2.8) at Level 2, the Match Referee may, instead, find the Player or Player Support Personnel guilty of the same offence at Level 1 and impose an appropriate sanction; and
- 7.10.6 where a fine and/or costs award is imposed against a Player or Player Support Personnel, then such fine and/or costs award must be paid: (a) by the Player or Player Support Personnel (and not any other third party, including a National Cricket Federation); (b) to the Player or Player Support Personnel's National Cricket Federation (for onward transmission to the ICC) within one calendar month of receipt of the decision imposing the fine. However, the ICC will consider any request from any Player or Player Support Personnel to make the payment of such fines and/or costs over a prolonged period of time on the grounds of financial hardship. Should any fine and/or costs award (or agreed part-payment or instalment thereof) not be paid to the relevant National Cricket Federation within such deadline or by the time of the next agreed payment date, the Player or Player Support Personnel may not play, coach or otherwise participate or be involved in any capacity in any International Match until such payment has been satisfied in full.

- 7.11** Where a Player or Player Support Personnel has had Suspension Points imposed against him/her or has been suspended for a fixed period of time, he/she may not play, coach or otherwise participate or be involved in any capacity in the International Match(es) whi

NOTE: For the avoidance of any doubt, a Player or (where relevant) Player Support Personnel who has had Suspension Points imposed against him/her or has been suspended for a fixed period of time shall not, during the International Matches which are covered by his/her Suspension Points or the period of suspension:

- a) be nominated as, or carry out any of the duties or responsibilities of, a substitute fielder; or
- b) enter any part of the playing area (which shall include, for the avoidance of doubt, the field of play and the area between the boundary and perimeter boards) at any time, including during any scheduled or unscheduled breaks in play.

In addition, Player Support Personnel so sanctioned shall not be permitted to enter the players' dressing room (including the viewing areas) during any International Match covered by his/her Suspension Points or the period of suspension. Players so sanctioned will, however, be permitted to enter the players' dressing room provided that the players' dressing room (or any part thereof) for the relevant International Match is not within the player area described in (b) above (for example, no such Player shall be permitted access to an on-field 'dug-out').

Finally, any Player or Player Support Personnel so sanctioned shall not be prevented from attending any post-match ceremonies or presentations taking place anywhere on the field of play or otherwise following the conclusion of an International Match covered by his/her Suspension Points or the period of suspension unless the suspension or Suspension Points have been imposed in respect of a Level 3 or Level 4 Offence under this Code of Conduct. In such circumstances, the Player or Player Support Personnel shall not be permitted to attend such ceremonies or presentations.

- 7.12** Once any Suspension Points or fixed period of suspension has expired, the Player or Player Support Personnel will automatically become re-eligible to participate (in the case of a Player) or assist the participation (in the case of a Player Support Personnel) in International Matches provided that he/she has paid, in full, all amounts forfeited under the Code of Conduct, including any fines, compensatory awards or award of costs that may have been imposed against him/her.

ARTICLE 8 – APPEALS

NOTE: For the avoidance of doubt, the right of appeal will be determined by reference to the level of offence which the decision of the Match Referee or Judicial Commissioner (as applicable) relates to, and not necessarily the Level of offence originally reported.

By way of example, a Judicial Commissioner may have been asked to determine a Level 4 Offence, but in coming to his/her decision, he/she has exercised the right afforded to him/her in Article 7.10.5 and found the Player or Player Support Personnel concerned not guilty of the Level 4 Offence, but guilty of a Level 3 Offence. In such circumstances, the right of appeal shall be determined on the basis of the Level 3 Offence and thus in accordance with Article 8.2.

In circumstances where the application of this note would lead to the same level of adjudicator hearing the appeal as heard the first instance case, then the relevant adjudicatory body shall be the higher body. By way of example, in the example listed above, an Appeal Panel would have the jurisdiction to hear the appeal against the Level 3 Offence even though technically under the Code of Conduct a Judicial Commissioner would hear the appeal, as the first instance hearing was held before a Judicial Commissioner. The terms of this Article 8 should therefore be construed accordingly.

8.1 Appeals from decisions in relation to a Level 1 Offence

8.1.1 Decisions made under the Code of Conduct by a Match Referee in relation to a Level 1 Offence shall be non-appealable and shall remain the full and final decision in relation to the matter.

8.2 Appeals from decisions in relation to: (a) a Level 2 or Level 3 Offence; or (b) a Minimum Over Rate Offence

8.2.1 Decisions made under the Code of Conduct by a Match Referee in relation to: (a) a Level 2 or Level 3 Offence; or (b) a Minimum Over Rate Offence, may be challenged solely by appeal as set out in this Article 8.2. Such decision shall remain in effect while under appeal unless any Judicial Commissioner properly convened to hear the appeal orders otherwise.

8.2.2 The only parties who may appeal a decision of this nature shall be: (a) the Player or Player Support Personnel found guilty of the offence or, where appropriate in the case of an offence under either Article 2.11 (manipulation of an International Match), 2.14 (changing the condition of the ball), or 2.22 (failure to meet the Minimum Over Rate), the relevant Team Captain; (b) the person who lodged the Report pursuant to Article 3.1; and (c) the ICC's Chief Executive Officer (or his/her designee).

8.2.3 Any notice to appeal under this Article must be lodged with the ICC's General Counsel within 48 hours of receipt of the written decision of the Match Referee. In all cases, a copy of such notice will also be provided to the CEO of the National Cricket Federation to which the Player or Player Support Personnel is affiliated and the person who lodged the Report pursuant to Article 3.1. Thereafter, the following will apply:

- 8.2.3.1 Upon filing a Notice of Appeal pursuant to this Article 8.2, the party appealing the decision shall pay to the ICC an appeal fee of US \$15,000 (the "Appeal Fee"). In circumstances where the appeal is successful (i.e. where either the sanction originally imposed is reduced, and/or the decision on guilt is overturned), the Appeal Fee shall be refunded to the appealing party.
- 8.2.3.2 Within 48 hours of receipt of a notice to appeal: (a) the ICC's General Counsel will appoint a member of the ICC's Code of Conduct Commission who is (unless otherwise agreed between the parties) from a country other than those participating in the International Match during, or in relation to which, the alleged offence was committed, to act as Judicial Commissioner and hear the appeal sitting alone; and (b) the Match Referee will provide a written statement to the ICC's General Counsel setting out any relevant facts (to be copied to the Player or Player Support Personnel).
- 8.2.3.3 The provisions of Articles 5.1.2 to 5.1.11, applicable to proceedings before the Match Referee, shall apply mutatis mutandis (ie with changes deemed to have been made as required to reflect the different context) to appeal hearings before the Judicial Commissioner.
- 8.2.3.4 The Judicial Commissioner shall hear and determine all issues arising from any matter which is appealed pursuant to this Article on a de novo basis, ie he/she shall hear the matter over again, from the beginning, without being bound in any way by the decision being appealed. For the avoidance of doubt, the Judicial Commissioner shall have the power to increase or decrease, amend or otherwise substitute a new decision on the appropriateness (or otherwise) of the sanction imposed at first instance, provided that any new sanction must be within the permitted range of sanctions set out in the table in Article 7.3 (or, where applicable, Article 4 of Appendix 2).
- 8.2.3.5 Appeal hearings pursuant to this Article 8.2 should be completed expeditiously. Save where all parties agree or fairness requires otherwise, the appeal hearing shall be commenced no later than seven (7) days after the appointment of the member of the Judicial Commissioner. It shall be open to the Judicial Commissioner, in his/her discretion, to determine that the matter (or any part thereof) be dealt with by way of written submissions only.
- 8.2.3.6 Any decision made by the Judicial Commissioner under this Article 8.2, shall be the full, final and complete disposition of the matter and will be binding on all parties.

8.3 Appeals from decisions in relation to a Level 4 Offence

- 8.3.1 Decisions made under the Code of Conduct by a Judicial Commissioner in relation to a Level 4 Offence may be challenged solely by appeal as set out in this Article 8.3. Such decision shall remain in effect while under appeal unless any properly convened Appeal Panel orders otherwise.
- 8.3.2 The only parties who may appeal a decision made in relation to a Level 4 Offence shall be: (a) the Player or Player Support Personnel found guilty of the offence; (b) the person who lodged the Report pursuant to Article 3.1; and (b) the ICC's Chief Executive Officer.
- 8.3.3 Any notice to appeal under this Article must be lodged with the ICC's General Counsel within seven (7) days of receipt of the written decision of the Judicial Commissioner. In all cases, a copy of such notice will also be provided to the CEO of the National Cricket Federation to which the Player or Player Support Personnel is affiliated. Thereafter, the following will apply:
 - 8.3.3.1 Upon filing a Notice of Appeal pursuant to this Article 8.3, the party appealing the decision shall pay to the ICC an Appeal Fee. In circumstances where the appeal is successful, the Appeal Fee shall be refunded to the appealing party.
 - 8.3.3.2 Within seventy-two (72) hours of receipt of a notice to appeal: (a) the ICC's General Counsel will appoint three members of the ICC's Code of Conduct Commission each of whom are (unless otherwise agreed between the parties) from a country other than those participating in the relevant International Match to sit as the Appeal Panel to hear the appeal; and (b) the Judicial Commissioner will provide a written statement to the ICC's General Counsel setting out any relevant facts (to be copied to the Player or Player Support Personnel).
 - 8.3.3.3 The provisions of Articles 5.2.2 to 5.2.14, applicable to proceedings before the Judicial Commissioner, shall apply mutatis mutandis (ie with changes deemed to have been made as required to reflect the different context) to appeal hearings before the Appeal Panel.
 - 8.3.3.4 Where required in order to do justice (for example to cure procedural errors at the first instance hearing), the appeal shall take the form of a re-hearing de novo of the issues raised by the case. In all other cases, the appeal shall not take the form of a de novo hearing but instead shall be limited to a consideration of whether the decision being appealed was erroneous.

- 8.3.3.5 Appeal hearings pursuant to this Article 8.3 should be completed expeditiously. Save where all parties agree or fairness requires otherwise, the appeal hearing shall be commenced no later than thirty (30) days after the appointment of the Appeal Panel. It shall be open to the Appeal Panel, in its discretion, to determine that the matter (or any part thereof) be dealt with by way of written submissions only.
- 8.3.3.6 Any decision made by the Appeal Panel under this Article 8.3, shall be the full, final and complete disposition of the matter and will be binding on all parties.

8.4 No appeal in relation to an accepted sanction

- 8.4.1 For the avoidance of doubt, where a Player or Player Support Personnel admits the offence charged and accedes to the proposed sanction specified in the Notice of Charge in accordance with the procedure described in Articles 4.23.1 or 4.7.1, the Player or Player Support Personnel waives his/her right to any appeal against the imposition of such a sanction.

ARTICLE 9 – RECOGNITION OF DECISIONS

- 9.1 Any hearing results or other final adjudications under the Code of Conduct shall be recognised and respected by the ICC and its National Cricket Federations automatically upon receipt of notice of the same, without the need for any further formality. Each of the ICC and its National Cricket Federations shall take all steps legally available to it to enforce and give effect to such decisions.
- 9.2 It shall be a condition of membership of the ICC that all National Cricket Federations shall comply with the Code of Conduct .

ARTICLE 10 – SANCTIONS AND COSTS ASSESSED AGAINST NATIONAL CRICKET FEDERATIONS

- 10.1 Where Players or Player Support Personnel representing one National Cricket Federation accumulate a combined total of 15 Demerit Points (which must arise from at least 6 separate Code of Conduct offences) within a twelve month period, that National Cricket Federation shall be deemed to have failed to ensure that their Players or Player Support Personnel uphold the Spirit of Cricket and consequently the ICC Board may, in its absolute discretion, impose a fine on the National Cricket Federation (up to a maximum of US\$ 100,000).

ARTICLE 11 – AMENDMENT AND INTERPRETATION OF THE CODE OF CONDUCT

- 11.1 The Code of Conduct may be amended from time to time by the Executive Board of the ICC, with such amendments coming into effect on the date specified by the ICC.
- 11.2 The headings used for the various Articles of the Code of Conduct are for the purpose of guidance only and shall not be deemed to be part of the substance of the Code of Conduct or to inform or affect in any way the language of the provisions to which they refer.
- 11.3 The Code of Conduct shall come into full force and effect on 1 August 2019 (the “Effective Date”). It shall not apply retrospectively to matters pending before the Effective Date; provided, however, that any case pending prior to the Effective Date, or brought after the Effective Date but based on an offence that is alleged to have occurred before the Effective Date, shall be governed by the predecessor version of the Code of Conduct in force at the time of the alleged offence, subject to any application of the principle of *lex mitior* by the hearing panel determining the case.
- 11.4 If any Article or provision of this Code of Conduct is held invalid, unenforceable or illegal for any reason, the Code of Conduct shall remain otherwise in full force apart from such Article or provision which shall be deemed deleted insofar as it is invalid, unenforceable or illegal.
- 11.5 The Code of Conduct is governed by and shall be construed in accordance with English law. Strictly without prejudice to the arbitration provisions of Articles 5 and 8 of the Code of Conduct, disputes relating to the Code of Conduct shall be subject to the exclusive jurisdiction of the English courts.

APPENDIX 1

DEFINITIONS

Appeal Fee. As defined in Article 8.2.3.1.

Appeal Panel. A panel of three persons appointed by the ICC from the members of the ICC Code of Conduct Commission to perform the functions assigned to the Appeal Panel under the Code of Conduct. Each member of the Appeal Panel shall be independent of the ICC, which may provide reasonable compensation and reimbursement of expenses to such members.

Associate Member. Any National Cricket Federation with associate member status of the ICC.

Complainant. As defined in Article 5.2.2.

Demerit Points. Points which are accrued by a Player or Player Support Personnel pursuant to Article 7 each time he/she commits an offence under the Code of Conduct.

Effective Date. As defined in Article 11.3.

Full Member. Any National Cricket Federation with full member status of the ICC.

ICC. The International Cricket Council or its designee.

ICC’s Chief Executive Officer. The person appointed by the ICC from time to time to act as the ICC’s Chief Executive Officer (or his/her designee).

ICC’s Chief Referee. The person appointed by the ICC from time to time to act as the ICC’s Chief Referee (or his/her designee).

ICC Classification of Official Cricket. The ICC Classification of Official Cricket, in force from time to time.

ICC’s Clothing and Equipment Regulations. The ICC’s Clothing and Equipment Regulations, in force from time to time.

ICC Code of Conduct Commission. An official committee of the ICC established, amongst other things, to enquire into conduct which is prejudicial to the interests of the game of cricket. Each member of the ICC Code of Conduct Commission shall be independent of the ICC, which may provide reasonable compensation and reimbursement of expenses to such members.

ICC Code of Conduct for Match Officials and Match Official Support Personnel. The ICC’s Code of Conduct for Match Officials and Match Official Support Personnel, in force from time to time.

ICC Events. Each of the following: (a) the ICC Cricket World Cup; (b) the ICC World Twenty20; (c) the ICC Champions Trophy; (d) the ICC World Cricket League Championship and Divisions 2-5 (inclusive), together with any regional qualifying events thereto; (e) the ICC Women's World Cup; (f) the ICC Under 19 Cricket World Cup; (g) the ICC World Cup Qualifying Tournament; (h) the ICC Women's World Cup Qualifying Tournament, together with any regional qualifying events thereto; (i) the ICC World Twenty20 Qualifying Tournament; (j) the ICC Under 19 Cricket World Cup Qualifying Tournament, together with any regional qualifying events thereto; (k) the ICC Intercontinental Cup; and (l) any other event organised or sanctioned by the ICC from time to time to which the ICC deems it appropriate that the Code of Conduct should apply. The Code of Conduct shall apply for the "Support Period" of the relevant ICC Event (as such term is defined by the ICC in respect of each ICC Event).

ICC's General Counsel. The person appointed by the ICC from time to time to act as the ICC's General Counsel (or his/her designee).

ICC Standard Test Match, ODI and T20I Playing Conditions. Each of the ICC's Men's and Women's Test Match, One Day International and Twenty20 International Playing Conditions, in force from time to time.

International Match. Each of the following (in men's and women's cricket): (a) any Test Match, One Day International Match or Twenty20 International Match; (b) any Match played as part of an ICC Event; (c) any Match played between representative sides of any National Cricket Federation at Under 19 level or above; (d) any International Tour Match; or (e) any other Match organised or sanctioned by the ICC from time to time to which the ICC deems it appropriate that the Code of Conduct should apply.

International Tour Match. Any Match played between a representative team of a Full Member (or Associate Member with Test and/or ODI or T20I Status) and any domestic, guest or invitational team.

Judicial Commissioner. The independent person appointed by the ICC from the ICC Code of Conduct Commission, to perform the functions assigned to the Judicial Commissioner under the Code of Conduct.

Level 1 Offence. Any offence charged at Level 1.

Level 2 Offence. Any offence charged at Level 2.

Level 3 Offence. Any offence charged at Level 3.

Level 4 Offence. Any offence charged at Level 4.

Match. A cricket match of any format and duration in length played between representative teams (male or female) of two National Cricket Federations affiliated to the ICC.

Match Fee. The designated match fee (which is to be used for the purposes of calculating sanctions in accordance with Article 7) as set out in Appendix 3 of this Code of Conduct.

Match Referee. The independent person appointed by the ICC (or any other relevant party) as the official match referee for a designated International Match, whether such Match Referee carries out his/her functions remotely or otherwise. Where a Match Referee is not physically present at a particular Match, he/she may be assisted in the administrative performance of his/her duties under this Code of Conduct by any official 'Match Manager' who may be appointed to officiate at such International Match.

Minimum Over Rate. As defined in Appendix 2 of this Code of Conduct.

Minimum Over Rate Offence. Any of the offences described in Articles 2.22.1 – 2.22.2.

Minor Over Rate Offence. As defined in Article 2.22.1.

National Cricket Federation. A national or regional entity which is a member of or is recognised by the ICC as the entity governing the sport of cricket in a country (or collective group of countries associated for cricket purposes).

Notice of Charge. As defined in Article 4.1, 4.2 and/or Article 4.6.

One Day International Match. As defined in the ICC Classification of Official Cricket.

Player. Any cricketer who is selected in any playing or touring team or squad that is chosen to represent a National Cricket Federation in any International Match or series of International Matches.

Player Support Personnel. Any coach, trainer, manager, selector, team official, doctor, physiotherapist or any other person employed by, representing or otherwise affiliated to a playing/touring team or squad that is chosen to represent a National Cricket Federation in any International Match or series of International Matches.

Report. As defined in Article 3.1.

Serious Over Rate Offence. As defined in Article 2.22.2.

Suspension Points. The weighting points used to determine the period of suspension imposed against any Player or Player Support Personnel pursuant to Article 7 of the Code of Conduct.

Team Captain or Vice Captain. The official captain or vice captain of any team participating in a Match.

Team Manager. The official manager of any team participating in a Match.

Test Match. As defined in the ICC Classification of Official Cricket.

Twenty20 International Match. As defined in the ICC Classification of Official Cricket.

Umpire. Any umpire (including any third or other umpires) appointed to officiate in a Match.

APPENDIX 2

MINIMUM OVER RATE REQUIREMENTS, CALCULATION, REPORTING AND DISCIPLINARY PROCESS AND SANCTIONS

1 MINIMUM OVER RATE

The minimum over rate to be achieved by the fielding team in all International Matches shall be as set out in the ICC Standard Test Match, ODI and T20I Playing Conditions applicable to the relevant International Match (the "Minimum Over Rate").

2 CALCULATING THE ACTUAL OVER RATE

- 2.1 The actual over rate will be calculated at the end of each International Match by those Umpires appointed to officiate in such International Match. In the case of Test Matches (or other International Matches of at least four days in duration), the actual over rate will be the average rate which is achieved by the fielding team across both of the batting team's innings.
- 2.2 In calculating the actual over rate for an International Match, allowances will be given for the actual time lost as a result of any of the following:
- 2.2.1 treatment given to a Player by an authorised medical personnel on the field of play;
 - 2.2.2 a Player being required to leave the field as a result of a serious injury;
 - 2.2.3 all TV Umpire referrals and consultations;
 - 2.2.4 time wasting by the batting side (which may, in addition, constitute a separate offence pursuant to Article 2.20 depending upon the context and seriousness of the incident); and
 - 2.2.5 all other circumstance that are beyond the control of the fielding team.
- 2.3 In addition, the following time allowances will be given:
- 2.3.1 in Test Matches (or other International Matches of at least four days in duration):
 - (a) 2 minutes per wicket taken, provided that such wicket results in the subsequent batter immediately commencing his/her innings. For the avoidance of any doubt, no time allowance will be given for the final wicket of an innings or where a wicket falls immediately prior to any interval; and
 - (b) 4 minutes per drinks break taken (one per session).

2.3.2 in Twenty20 International Matches:

- (a) 1 minute for every 3 full overs that an innings is reduced by as a result of any delay and/or interruption in play.

2.4 Further, the following exclusions and exemptions will be applied:

- 2.4.1 in Test Matches (or other International Matches of at least four days in duration):
 - (a) if the fielding team bowls out the batting team in 60 overs or less in any particular innings and the Minimum Over Rate requirement for that innings has not been exceeded (taking into account all of the time allowances described in this Article 2), no account shall be taken of the actual over rate in that innings when calculating the actual over rate at the end of such Match.
 - (b) if the fielding team bowls out the batting team twice but has not completed more than 120 overs in total across both of its completed fielding innings in doing so, no sanction will be imposed in respect of any breach of the Minimum Over Rate.
 - (c) if the fielding team has not completed more than 60 overs in total in the course of its two innings in a Match, no sanction will be imposed in respect of any breach of the Minimum Over Rate.
- 2.4.2 in One Day International Matches or Twenty20 International Matches:
 - (a) if the fielding team bowls out the batting team within the time determined for that innings pursuant to the ICC's Standard ODI or T20I Playing Conditions (as applicable), no sanction will be imposed in respect of any breach of the Minimum Over Rate.

3 PROCEDURE

- 3.1 Where the actual over rate is calculated by the Umpires as being equal to or in excess of the Minimum Over Rate, no further action shall be taken.
- 3.2 Where the actual over rate is calculated by the Umpires as being less than the Minimum Over Rate, the following shall apply:
 - 3.2.1 only the Umpires that officiated in the International Match during which the alleged offence was committed can report such an offence to the Match Referee, and such Report, which must be completed on Form "Rep 1" must be lodged with the Match Referee (or, where, for logistical reasons, it is impractical to lodge with the Match Referee, the ICC's Cricket Operations Department) within 18 hours of the close of the day's play in the relevant International Match or prior to the start of the following day's play, whichever is the sooner;
 - 3.2.2 thereafter, the Match Referee shall promptly consult with the Umpires and shall be entitled, after such consultation, to make such amendments to the actual over rate calculation as he/she deems appropriate in the circumstances to reflect those circumstances that are beyond the control of the fielding team (including, but not limited to those set out in Article 2 of this Appendix 2).

3.2.3 where the Match Referee confirms that the Minimum Over Rate has not been achieved by the fielding side in any International Match, this shall constitute an offence under Article 2.22 of the Code of Conduct and the Match Referee will promptly issue a Notice of Charge in accordance with Article 4.1 of the Code of Conduct (with the Team Captain being charged on behalf of all the Players in the fielding side as well as him/herself) and the matter will be thereafter be adjudicated by the Match Referee in accordance with the procedure set out in Article 5.

4 APPLICABLE SANCTIONS FOR A MINIMUM OVER RATE OFFENCE

4.1 For the purposes of Minimum Over Rate Offences only, the table at Article 7.3 of the Code of Conduct shall be replaced with the following:

BREACH	CHARGED	RANGE OF PERMISSIBLE SANCTIONS
Over Rate Offence (Article 2.22)	All 11 Players in the fielding team	20% of Match Fee per over short of Minimum Over Rate (subject to a maximum cap of 100% of Match Fee).

4.2 For the avoidance of doubt, Demerit Points shall not be applied in respect of any Minimum Over Rate Offence.

APPENDIX 3

MATCH FEES

Unless otherwise agreed in advance of an International Match or ICC Event, for the purposes of any sanctions that are to be applied pursuant to this Code of Conduct, the following designated Match Fees shall apply:

TYPE OF INTERNATIONAL MATCH	DESIGNATED MATCH FEE
Any Test Match, One Day International Match or Twenty20 International Matches (other than Twenty20 International Matches (men's or women's) taking place between teams which do not hold ODI status).	A country-specific amount which is to be determined by the ICC's Chief Executive's Committee in consultation with the relevant National Cricket Federations.
All other International Matches.	The applicable Match Fee will be zero. Accordingly, while a Match Referee or Judicial Commissioner will have jurisdiction under this Code of Conduct to impose a financial sanction against any Player or Player Support Personnel for a breach of this Code of Conduct the effect of such sanction will be zero in a financial sense. However, the corresponding Demerit Points applicable to such a fine will be added to the relevant Player or Player Support Personnel's disciplinary record. Further, the remaining range of permissible sanctions (set out in the tables in Article 7.3 and Article 4 of Appendix 2) shall be available to the Match Referee and/or Judicial Commissioner in full.

For the avoidance of doubt, the designated Match Fee to be applied for the purposes of an offence committed by a Player Support Personnel shall be the same as that which would be applied to a Player from the same National Cricket Federation participating in the same International Match.

APPENDIX 4

EXPEDITED PROCEDURE FOR CODE OF CONDUCT OFFENCES OCCURRING DURING AN ICC EVENT

Where a Code of Conduct offence is alleged to have occurred during, or in relation to, an International Match that is played as part of an ICC Event (except the ICC Intercontinental Cup or the ICC World Cricket League Championship inclusive in which no expedited procedure is to be applied), the provisions of the Code of Conduct shall apply in full save for the amendments described in this Appendix 4, which are deemed to be made in order to ensure that any matters arising can be dealt with expediently:

ARTICLE 3 – REPORTING AN ALLEGED OFFENCE UNDER THE CODE OF CONDUCT

- Article 3.2.1(b) – “twenty-four (24) hours” is replaced with “eighteen (18) hours”.
- Article 3.2.1.2 – “forty-eight (48) hours (where the Report is lodged by an Umpire) or ninety-six (96) hours (where the Report is lodged by the Team Manager or CEO of either of the two relevant National Cricket Federations)” is replaced with “eighteen (18) hours”.
- Article 3.2.1.4 – “seven (7) days” is replaced with “thirty-six (36) hours”.
- Article 3.2.2.1 – “five (5) days” is replaced with “twenty-four (24) hours”.
- Article 3.2.2.2 – “seven (7) days” is replaced with “thirty-six (36) hours”.
- Article 3.2.3 – “seven (7) days” is replaced with “thirty-six (36) hours”.

ARTICLE 4 – NOTIFICATION PROCEDURE

- Article 4.3.2 – “Article 5.1” is replaced with “Article 5.1.1”
- Article 4.3.3 – “Article 5.1” is replaced with “Article 5.1.1”
- Article 4.7.2 – “Article 5.2” is replaced with “Article 5.1.2”
- Article 4.7.3 – “Article 5.2” is replaced with “Article 5.1.2”

ARTICLE 5 – THE DISCIPLINARY PROCEDURE

- Articles 5.1 and 5.2 are replaced in their entirety with the following:

5.1 Where a matter proceeds to a hearing:

- 5.1.1 under Article 4.3.2 or 4.3.3, then, subject to Article 5.7, the case shall be referred to the Match Referee for adjudication in accordance with the procedure described in Article 5.2.
- 5.1.2 under Article 4.7.2 or 4.7.3, then the ICC shall appoint one member of the ICC’s Code of Conduct Commission (who shall be independent of the parties, have had no prior involvement with the case and shall not, unless otherwise agreed between the parties, be from a country participating in the International Match, during, or in relation to which, the alleged offence was committed) to sit alone as the Judicial Commissioner and the case shall be referred to him/her for adjudication in accordance with the procedure described in Article 5.2.

5.2 Disciplinary Procedure during an ICC Event

- 5.2.1 Subject to the discretion of the Match Referee or Judicial Commissioner to order otherwise for good cause shown by the Player or Player Support Personnel, the hearing will take place at the time specified in the Notice of Charge (which should, in the absence of exceptional circumstances, be no more than twenty-four (24) hours after the receipt by the Player or Player Support Personnel of the Notice of Charge) and in the country in which the alleged offence was committed. For the avoidance of doubt, nothing in this Article 5.2.1 prevents a hearing from being convened at a time during which the International Match in relation to which the alleged offence took place, remains in progress.
- 5.2.2 The procedure followed at the hearing shall be at the discretion of the Match Referee or Judicial Commissioner, provided that the hearing is conducted in a manner which offers the Player or Player Support Personnel with a fair and reasonable opportunity to present evidence (including the right to call and to question witnesses by telephone or video-conference where necessary), address the Match Referee or Judicial Commissioner and present his/her case.
- 5.2.3 The hearing before the Match Referee or Judicial Commissioner shall be in English, and certified English translations shall be submitted of any non-English documents put before the Match Referee or Judicial Commissioner. The cost of the translation shall be borne by the party offering the document(s). In the case of a Level 4 Offence only: (a) if required by the Judicial Commissioner (at his/her discretion), the ICC shall make arrangements to have the hearing recorded or transcribed; and (b) if requested by the Player or Player Support Personnel, the ICC shall also arrange for an interpreter to attend the hearing. Such costs of transcription and interpretation shall be paid by the ICC.
- 5.2.4 Where video evidence of the alleged offence is available at the hearing before the Match Referee or Judicial Commissioner, then it may be relied upon by any party, provided that all other parties shall have the right to make such representations in relation to it that they may see fit.
- 5.2.5 Unless exceptional circumstances apply, each of the following individuals must attend any hearing before the Match Referee or Judicial Commissioner: (a) the Player or Player Support Personnel who has been charged with the alleged offence; and (b) the person who lodged the Report (or, in the case of the ICC’s Chief Executive Officer, his/her representative/nominee). Where any such individual has a compelling justification for his/her non-attendance, then they shall be given the opportunity to participate in the hearing before the Match Referee or Judicial Commissioner by telephone or video conference (if available). Without prejudice to the Player or Player Support Personnel’s ability to call and to question such witnesses as may be necessary and/or to be represented by such other person of his/her own choosing pursuant to Article 5.2.6, one of the Team Captain, Team Vice-Captain or Team Manager of the team that the Player or Player Support Personnel represents may also attend such hearing before the Match Referee or Judicial Commissioner to provide additional support and assistance to the Player or Player Support Personnel.

- 5.2.6 Each of the individuals described in Article 5.2.5(a) and (b) shall have the right (at his/her or its own expense) to be represented at the hearing before the Match Referee or Judicial Commissioner by such representative (including legal counsel) of his/her or its own choosing. Where the person lodging the Report is an Umpire or Match Referee that officiated in the International Match in question or the ICC's Chief Executive Officer, then such person shall be entitled to be represented prior to, and during, the hearing (if he/she considers necessary) by a representative of the ICC's Legal Department. In the case of a Level 4 Offence only, where the person lodging the Report is the CEO of one of the National Cricket Federations involved in the relevant International Match (or his/her designee), such individual (or his/her representative) shall have the right to make oral submissions in support of the charge at the hearing.
- 5.2.7 The non-attendance of any Player or Player Support Personnel or his/her representative at the hearing, shall not prevent the Match Referee or Judicial Commissioner from proceeding with the hearing in his/her absence and issuing a ruling in relation to the offence charged.
- 5.2.8 At the end of a hearing, where the Match Referee or Judicial Commissioner considers that further evidence is necessary or further time is required to consider the evidence that has been presented, he/she shall adjourn the hearing for an appropriate period of time and make such directions as may be necessary.
- 5.2.9 Alternatively, at the end of a hearing:
- 5.2.9.1 brought under Article 4.3.2:
- (a) as soon as possible after the conclusion of the hearing (and, in any event, no later than twenty-four (24) hours thereafter), the Match Referee or Judicial Commissioner will confirm the Player or Player Support Personnel's admission that he/she had committed a Code of Conduct offence and announce his/her decision in writing, with reasons, setting out: (a) what sanctions, if any, are to be imposed (including any fine and/or period of suspension); (b) the date that any period of suspension shall come into force and effect; and (c) any rights of appeal that may exist pursuant to Article 8.
- 5.2.9.2 brought under Article 4.3.3 (or where the Player or Player Support Personnel has failed to respond in a timely fashion to the Notice of Charge):
- (a) the Match Referee or Judicial Commissioner shall adjourn the hearing (for a period of no less than ten (10) minutes and no more than two (2) hours), following which he/she will reconvene the hearing and verbally announce his/her finding as to whether a Code of Conduct offence has been committed;

- (b) where the Match Referee or Judicial Commissioner determines that a Code of Conduct offence has been committed, the Player or Player Support Personnel may request a short adjournment (of no more than thirty (30) minutes) to prepare any submissions that he/she might wish to make in relation to the appropriate sanction that ought to be applied; and
- (c) as soon as possible after the conclusion of the hearing (and, in any event, no later than twenty-four (24) hours thereafter), the Match Referee or Judicial Commissioner will announce his/her decision in writing, with reasons, setting out: (a) the finding as to whether a Code of Conduct offence had been committed; (b) what sanctions, if any, are to be imposed (including any fine and/or period of suspension); (c) the date that any period of suspension shall come into force and effect; and (d) any rights of appeal that may exist pursuant to Article 8.
- 5.2.10 The Match Referee shall have the discretion to announce the substance of his/her decision prior to the issue of the written reasoned decision referred to in Article 5.2.9.
- 5.2.11 A copy of the written reasoned decision will be provided to the Player or Player Support Personnel, the CEO of the Player or Player Support Personnel's National Cricket Federation, and the ICC's Cricket Operations Manager.
- 5.2.12 Subject only to the rights of appeal under Article 8, the Match Referee's or Judicial Commissioner's decision shall be the full, final and complete disposition of the matter and will be binding on all parties.

ARTICLE 8 – APPEALS

- Article 8.2.3 - "48 hours" is replaced with "24 hours".
- Article 8.2.3.2 - "48 hours" is replaced with "24 hours".
- Article 8.2.3.3 - "Articles 5.1.2 to 5.1.11" is replaced with "the amended Articles 5.1 and 5.2".
- Article 8.2.3.5 - "seven days" is replaced with "48 hours".
- Article 8.3.3 - "seven (7) days" is replaced with "48 hours".
- Article 8.3.3.3 - "Articles 5.2.2 to 5.2.14" is replaced with "the amended Articles 5.1 and 5.2".
- Article 8.3.3.5 - "thirty (30) days" is replaced with "72 hours".

ICC ANTI-DISCRIMINATION CODE FOR PARTICIPANTS

ICC ANTI-DISCRIMINATION CODE FOR PARTICIPANTS

CONTENTS

ARTICLE 1	SCOPE AND APPLICATION	15.2
ARTICLE 2	OFFENCE	15.4
ARTICLE 3	REPORTING AN ALLEGED OFFENCE UNDER THE ANTI-DISCRIMINATION CODE	15.4
ARTICLE 4	NOTIFICATION AND CONCILIATION PROCEDURE	15.5
ARTICLE 5	THE DISCIPLINARY PROCEDURE	15.8
ARTICLE 6	STANDARD OF PROOF AND EVIDENCE	15.13
ARTICLE 7	SANCTIONS	15.14
ARTICLE 8	APPEALS	15.18
ARTICLE 9	RECOGNITION OF DECISIONS	15.19
ARTICLE 10	AMENDMENT AND INTERPRETATION OF THE ANTI-DISCRIMINATION CODE	15.19
APPENDIX 1	DEFINITIONS	15.20
APPENDIX 2	EXPEDITED PROCEDURE FOR OFFENCES UNDER THE ANTI-DISCRIMINATION CODE OCCURRING DURING AN ICC EVENT	15.23

INTRODUCTION

The ICC is the international federation responsible for the global governance of the sport of cricket and the Anti-Discrimination Code for Participants (the “**Anti-Discrimination Code**”) is adopted and implemented as part of the ICC’s continuing efforts to maintain the public image, popularity and integrity of cricket by providing: (a) an effective means to deter any participant from conducting themselves in a manner that may be construed as discriminatory or offensive based upon certain protected personal characteristics of another; and (b) a robust disciplinary procedure pursuant to which all matters of improper conduct of this nature can be dealt with fairly, with certainty and in an expeditious manner.

Unless otherwise indicated, references to Articles and Appendices are to articles and appendices of the Anti-Discrimination Code. Words in italicised text in the Anti-Discrimination Code are defined terms and their definitions are set out in Appendix 1.

ARTICLE 1 – SCOPE AND APPLICATION

- 1.1 All Participants are automatically bound by and required to comply with all of the provisions of the Anti-Discrimination Code. Accordingly, by their participation (in the case of a Player) or assistance in participation (in the case of a Player Support Personnel) or appointment to officiate (in the case of an Umpire or Match Referee) or appointment to support an Umpire or Match Referee (in the case of an Umpire Support Personnel) in an International Match, such Participants shall be deemed to have agreed:
 - 1.1.1 that it is their personal responsibility to familiarise themselves with all of the requirements of the Anti-Discrimination Code, including what conduct constitutes an offence under the Anti-Discrimination Code;
 - 1.1.2 to submit to the exclusive jurisdiction of any Judicial Commissioner or Appeal Panel convened under the Anti-Discrimination Code to hear and determine charges brought (and any appeals in relation thereto) pursuant to the Anti-Discrimination Code; and
 - 1.1.3 not to bring any proceedings in any court or other forum that are inconsistent with the foregoing submission to the jurisdiction of the Judicial Commissioner or Appeal Panel.
- 1.2 All Participants shall continue to be bound by and required to comply with the Anti-Discrimination Code until he/she has not participated (in the case of a Player), or assisted a Player’s participation (in the case of a Player Support Personnel), or officiated (in the case of an Umpire or Match Referee), or been appointed to support an Umpire or Match Referee (in the case of an Umpire Support Personnel) in an International Match for a period of three (3) months and the ICC shall continue to have jurisdiction over him/her under the Anti-Discrimination Code thereafter in respect of matters taking place prior to that point.

- 1.3 Without prejudice to Articles 1.1 and 1.2, the ICC and the National Cricket Federations shall be responsible for promoting Anti-Discrimination Code awareness and education amongst all Participants.
- 1.4 It is acknowledged that certain Participants may also be subject to other rules of National Cricket Federations that govern discipline and/or conduct, and that the same conduct of such Participants may implicate not only the Anti-Discrimination Code but also such other rules that may apply. For the avoidance of any doubt, Participants acknowledge and agree that: (a) the Anti-Discrimination Code is not intended to limit the responsibilities of any Participant under such other rules; and (b) nothing in such other rules shall be capable of removing, superseding or amending in any way the jurisdiction of the Judicial Commissioner or Appeal Panel to determine matters properly arising pursuant to the Anti-Discrimination Code.
- 1.5 The conduct prohibited under the Anti-Discrimination Code may also constitute a breach of other applicable laws or regulations (e.g. governing equal opportunities and/or anti-discrimination). The Anti-Discrimination Code is intended to supplement such laws and regulations with further rules of professional conduct for those involved in the sport of cricket. It is not intended, and may not be interpreted, construed or applied, to prejudice or undermine in any way the application of such laws and regulations. Participants must comply with all applicable laws and regulations at all times.
- 1.6 For the avoidance of any doubt:
 - 1.6.1 the Anti-Discrimination Code is not intended in any way to replace the ICC Anti-Discrimination Policy for International Cricket (as amended from time to time) which shall remain in full force and effect and to which the ICC and all National Cricket Federations agree to be bound at all times; and
 - 1.6.2 where a representative side of a National Cricket Federation participates in an International Tour Match against a domestic or invitational team, for the purposes of their participation in such International Tour Match:
 - 1.6.2.1 all Players and Player Support Personnel representing the National Cricket Federation’s representative side are automatically bound by, required to comply with, and shall submit themselves to the jurisdiction of this Anti-Discrimination Code; and
 - 1.6.2.2 all players or player support personnel representing the domestic or invitational team shall not be bound by this Anti-Discrimination Code. Instead, such individuals will be bound by, required to comply with, and shall submit themselves to the jurisdiction of the relevant National Cricket Federation’s own applicable rules of conduct.

ARTICLE 2 – OFFENCE

- 2.1 The following conduct, if committed by a Participant at any time during, or in relation to, an International Match, shall amount to an offence under the Anti-Discrimination Code:
- 2.1.1 Engaging in any conduct (whether through the use of language, gestures or otherwise) which is likely to offend, insult, humiliate, intimidate, threaten, disparage or vilify any reasonable person in the position of a Player, Player Support Personnel, Umpire, Match Referee, Umpire Support Personnel or any other person (including a spectator) on the basis of their race, religion, culture, colour, descent, national or ethnic origin, sex, gender, sexual orientation, disability, marital status and/or maternity status

ARTICLE 3 – REPORTING AN ALLEGED OFFENCE UNDER THE ANTI-DISCRIMINATION CODE

NOTE: Where an offence under the Anti-Discrimination Code is alleged to have occurred during, or in relation to, an International Match that is played as part of an ICC Event, the Anti-Discrimination Code shall apply in full, but with a series of amendments to the reporting, notification, disciplinary and appeals procedure (Articles 3, 4, 5 and 8) in order to ensure that any matters arising can be dealt with expediently. Such amendments are described in detail in Appendix 2.

- 3.1 Any one of the following individuals can report an alleged offence under the Anti-Discrimination Code by lodging a report in the manner described in Article 3.2, below (a **“Report”**):
- 3.1.1 an Umpire that officiated in the International Match during, or in relation to which, the alleged offence was committed;
- 3.1.2 the Match Referee that was appointed to officiate in the International Match during, or in relation to which, the alleged offence was committed;
- 3.1.3 the Team Manager or CEO of either of the two National Cricket Federations whose representative teams participated in the International Match during, or in relation to which, the alleged offence was committed; or
- 3.1.4 the ICC’s Chief Executive Officer.
- 3.2 All Reports must be completed on Form “Rep 1” (or such other form as may be made available for such purposes by the ICC from time to time). All Reports must be signed and dated by the person lodging the Report and must be lodged with the Match Referee (or, where, for logistical reasons, it is impractical to lodge with the Match Referee, the ICC’s Legal Department) as soon as reasonably practicable, and in any event no later than seven (7) days after: (a) the commission of the alleged offence; or (b) the alleged offence was brought to the attention of the person lodging the Report.
- 3.3 Where it is alleged that a Participant has committed more than one offence under the Anti-Discrimination Code during, or in relation to, an International Match (whether arising out of the same set of facts or otherwise), then a separate Report should be filed in accordance with this Article 3 for each of the offences alleged to have been committed.

ARTICLE 4 – NOTIFICATION AND CONCILIATION PROCEDURE

- 4.1 Where a Match Referee (or, as applicable, the ICC’s Legal Department) receives a Report lodged under Article 3, he/she must promptly submit the Report to the ICC’s General Counsel. Upon receipt of a Report, the ICC’s General Counsel must promptly carry out an investigation into the circumstances detailed in the Report (which may include speaking with relevant parties and reviewing relevant documents and other supporting materials) in order to determine whether the Participant named in the Report has a case to answer.
- 4.2 If the initial review of the Report reveals that there is no case to answer, then the ICC shall notify the person who filed the Report of that fact, and the matter shall not proceed any further.
- 4.3 If the initial review of the Report reveals that there is a case to answer, then, provided that the ICC consents to the matter being resolved by a process of conciliation (such consent not to be withheld unless it determines, acting reasonably, that the circumstances of the matter do no merit resolution by conciliation or there is a genuine and reasonable concern that a just and appropriate resolution of the matter will not be reached through a process of conciliation), the ICC shall comply with the following procedure:
- 4.3.1 The ICC’s General Counsel shall notify the following individuals of their entitlement to have the matter referred at the first instance to a process of conciliation and seek express written consent from each of them, within a period specified by the ICC’s General Counsel in his/her notice, to proceed on that basis:
- 4.3.1.1 the Participant named in the Report; and
- 4.3.1.2 the individual(s) who has/have been the subject of the alleged offence.
- 4.3.2 Where the ICC does not consent to the matter being resolved by a process of resolution or where the ICC’s General Counsel is unable to obtain the express written consent from both of the individuals described in Articles 4.3.1.1 and 4.3.1.2 within the deadline specified in the notice, then the matter shall not be referred to a process of conciliation, instead it shall proceed in accordance with Article 4.4.
- 4.3.3 Where a matter proceeds to conciliation under Article 4.3.1, then the case shall be referred to a Conciliator who shall be responsible for overseeing a process of conciliation to take place as soon as possible and, unless exceptional circumstances apply, no later than fourteen (14) days after the receipt by the ICC’s General Counsel of the consents described in Article 4.3.1, in accordance with the following procedure:
- 4.3.3.1 The ICC shall appoint one independent Conciliator who will oversee the conciliation sitting alone. For the avoidance of doubt, the appointed Conciliator may be from a country participating in the International Match during, or in relation to which, the alleged offence was committed, provided that the Conciliator remains independent of the relevant parties and the ICC at all times.

- 4.3.3.2 Unless exceptional circumstances apply, each of the parties identified in Articles 4.3.1.1 and 4.3.1.2, together with: (a) the person who lodged the Report (or, in the case of the ICC's Chief Executive Officer, his/her nominee); and (b) a representative of the ICC's Legal Department, must attend any conciliation meeting that is scheduled by the Conciliator. Each individual shall have the right (at his/her or its own expense) to be represented at such conciliation meeting by such representative (including legal counsel) of his/her or its own choosing and to make submissions to the Conciliator. Where any such individual has a compelling justification for his/her non-attendance, then they shall be given the opportunity to participate in the conciliation by telephone or video conference (if available). In addition, where the Participant charged is a Player or Player Support Personnel, any one of the Team Captain, Team Vice Captain or Team Manager of the team that any Player or Player Support Personnel attending such conciliation meeting represents, may also attend such conciliation meeting to provide additional support and assistance to that Player or Player Support Personnel.
- 4.3.3.3 Subject to the discretion of the Conciliator (or the ICC in circumstances where the Conciliator is yet to be appointed) to order otherwise for good cause shown by either party, conciliation meetings shall take place in the country in which the alleged offence was committed.
- 4.3.3.4 All of the parties involved in the conciliation procedure must fully engage with the Conciliator and the conciliation procedure with an open mind and must act, at all times, honestly and in good faith.
- 4.3.3.5 The procedure which is to be followed prior to, and during the conciliation meeting shall be entirely at the discretion of the Conciliator, provided that any such meeting is conducted in an open, inquisitive, non-adversarial and fair manner which enables all of the attending parties a reasonable opportunity to present any evidence that is deemed by the Conciliator to be appropriate and to address the Conciliator on any matter relevant to the alleged offence. In accordance with Article 6.2, all statements, submissions and evidence made, heard or disclosed during any part of the conciliation process shall be so made, heard or disclosed strictly (unless the relevant party agrees otherwise) on a 'without prejudice' basis and may only be used by any party for the purposes of the conciliation process only.

- 4.3.3.6 During the conciliation meeting, the Conciliator will discuss the circumstances of the alleged offence with the relevant parties and explore the possibility of reaching a consensual solution for how to resolve the matter without invoking the disciplinary procedure set out in Article 5. Such a solution may incorporate, without limitation, any of the following (or any combination of the following) outcomes: (a) the voluntary imposition of a period of suspension (which period must be determined having due regard to the range of permissible sanctions in Article 7.3) by the Participant alleged to have committed the offence; and/or (b) a public apology and/or explanation as to the parties' conduct and circumstances surrounding the alleged offence; and/or (c) a private apology and/or explanation as to the parties' conduct and circumstances surrounding the alleged offence; and/or (d) a joint press statement being issued about the parties' conduct and circumstances surrounding the alleged offence and/or its resolution by conciliation; and/or (e) an agreement by the Participant alleged to have committed the offence, to undergo a specified programme of education and/or counselling designed to promote the understanding and awareness of issues directly relevant to the offence that is alleged to have been committed.
- 4.3.3.7 At the end of the conciliation meeting, if the Conciliator is satisfied that all of the parties have reached a consensual resolution of the matter, then he/she shall document such resolution and arrange for the signature of all relevant parties to be attested to such document. Any consensual resolution reached by all parties during such conciliation meeting shall be the full, final and complete disposition of the matter and will be binding on all parties.
- 4.3.3.8 At the end of the conciliation meeting, if the Conciliator is not satisfied that all of the parties have reached a consensual resolution of the matter, then the conciliation process shall be terminated immediately and the matter shall proceed in accordance with Article 4.4.
- 4.3.3.9 The ICC will issue a public announcement regarding any consensual resolution reached by all the parties during the conciliation meeting as soon as reasonably practicable after the end of the conciliation meeting. The public announcement may include details of the identity of the Conciliator and the process followed, as well as the offence committed and the terms of any agreed resolution. Until such time as a public announcement is published by the ICC, all parties involved in the conciliation procedure shall treat such procedure as strictly confidential. For the avoidance of doubt, nothing in this Article shall prevent the ICC or either of the parties (or any relevant National Cricket Federation) publicly confirming the date of any conciliation meeting, the offence that is alleged to have been committed and/or the name of the Participant charged.

- 4.4 If the initial review of the Report reveals that there is a case to answer and either: (a) the ICC did not consider it to be an appropriate matter for resolution through conciliation (Article 4.3); or (b) the relevant parties did not consent to the matter being resolved through a conciliation process (Article 4.3.2); or (b) following a conciliation meeting the Conciliator was not satisfied that the parties were able to reach a consensual resolution (Article 4.3.3.8), then the ICC shall promptly provide a copy of the Report, together with a completed Form "Not 1" (such documents comprising the **'Notice of Charge'**) to the following individuals:
- 4.4.1 the Participant named in the Report;
 - 4.4.2 where applicable, the Team Manager of the relevant Participant named in the Report; and
 - 4.4.3 where applicable, the CEO of the National Cricket Federation to which the relevant Participant is affiliated.
- 4.5 The Notice of Charge shall specify that the Participant shall have the following options:
- 4.5.1 he/she may admit the offence charged and accede to the proposed sanction specified in the Notice of Charge (which sanction shall be strictly at the ICC's discretion, but at all times within the appropriate range for the offence). In such circumstances, and provided that such admission has been received by the ICC's General Counsel prior to the commencement of the hearing at the time/place specified in the Notice of Charge, the hearing before the Judicial Commissioner shall not be required and no further action shall be taken, save that the ICC shall promptly issue a public statement confirming: (a) the commission of an offence under the Anti-Discrimination Code; and (b) the imposition of the applicable sanction specified in the Notice of Charge; or
 - 4.5.2 he/she may admit the offence charge but dispute the proposed sanction specified in the Notice of Charge, in which case the matter shall proceed to a hearing in accordance with Article 5.1; or
 - 4.5.3 he/she may deny the offence charged, in which case the matter shall proceed to a hearing in accordance with Article 5.1.

ARTICLE 5 – THE DISCIPLINARY PROCEDURE

- 5.1 Where a matter proceeds to a hearing under Article 4.5.2 or 4.5.3, then the case shall be referred to a Judicial Commissioner for adjudication in accordance with the following procedure:
- 5.1.1 As soon as reasonably possible, the ICC shall appoint one member from the ICC's Code of Conduct Commission to sit as the Judicial Commissioner to hear the case sitting alone. The appointed member shall be independent of the parties, have had no prior involvement with the case and shall not, unless otherwise agreed between the parties, be from a country participating in the International Match during, or in relation to which, the alleged offence was committed, or, where the Participant charged is an Umpire, Match Referee or Umpire Support Personnel, be from the same country as the relevant Participant.

- 5.1.2 The Judicial Commissioner shall convene a preliminary hearing with the ICC and its legal representatives, and with the Participant and his/her legal representatives (if any). The preliminary hearing should take place as soon as possible (provided that the Participant shall be given a reasonable period of notice of the same) by telephone conference call unless the Judicial Commissioner determines otherwise. The non-participation of the Participant or his/her representative at the preliminary hearing shall not prevent the Judicial Commissioner from proceeding with the preliminary hearing, whether or not any written submissions are made on behalf of the Participant.
- 5.1.3 The purpose of the preliminary hearing shall be to allow the Judicial Commissioner to address any preliminary issues. In particular (but without limitation), the Judicial Commissioner shall:
 - 5.1.3.1 determine the date(s) upon which the full hearing shall be held. Save in exceptional circumstances or where the parties otherwise agree, the full hearing should take place no longer than fourteen (14) days after the receipt by the Participant of the Notice of Charge;
 - 5.1.3.2 establish dates reasonably in advance of the date of the full hearing by which:
 - (a) the ICC shall submit an opening brief with argument on all issues that the ICC wishes to raise at the hearing and a list of the witnesses that the ICC intends to call at the hearing (and a summary of the subject areas of the witness's anticipated testimony), and enclosing copies of the exhibits that the ICC intends to introduce at the hearing;
 - (b) the Participant shall submit an answering brief, addressing the ICC's arguments and setting out argument on the issues that he/she wishes to raise at the hearing, as well as a list of the witnesses that he/she intends to call at the hearing (and a summary of the subject areas of the witness's anticipated testimony), and enclosing copies of the exhibits that he/she intends to introduce at the hearing; and
 - (c) the ICC may (at its discretion) submit a reply brief, responding to the answer brief of the Participant and listing any rebuttal witnesses that the ICC intends to call at the hearing (and a summary of the subject areas of the witness's anticipated testimony), and enclosing copies of any other exhibits that the ICC intends to introduce at the hearing; and
 - 5.1.3.3 make such order as the Judicial Commissioner shall deem appropriate in relation to the production of relevant documents and/or other materials between the parties.
- 5.1.4 Subject to the discretion of the Judicial Commissioner to order otherwise for good cause shown by either party, hearings before the Judicial Commissioner shall take place in the country in which the alleged offence was committed.

- 5.15 The procedure followed at the hearing shall be at the discretion of the Judicial Commissioner, provided that the hearing is conducted in a manner which offers the Participant a fair and reasonable opportunity to present evidence (including the right to call and to question witnesses by telephone or video-conference where necessary), address the Judicial Commissioner and present his/her case. For the avoidance of any doubt, in accordance with Article 6.2, unless the relevant party agrees otherwise, no evidence shall be adduced, given or accepted during any hearing before the Judicial Commissioner in relation to anything that may have been said or disclosed during any part of any 'without prejudice' conciliation process carried out pursuant to Article 4.3.
- 5.16 The hearing before the Judicial Commissioner shall be in English, and certified English translations shall be submitted of any non-English documents put before the Judicial Commissioner. The cost of the translation shall be borne by the party offering the document(s). If required by the Judicial Commissioner (at his/her discretion), the ICC shall make arrangements to have the hearing recorded or transcribed. If requested by the Participant, the ICC shall also arrange for an interpreter to attend the hearing. Such costs of transcription and interpretation shall be paid by the ICC.
- 5.17 Where video evidence of the alleged offence is available at the hearing before the Judicial Commissioner, then it may be relied upon by any party, provided that all other parties shall have the right to make such representations in relation to it that they may see fit.
- 5.18 Unless exceptional circumstances apply, each of the following individuals must attend any hearing before the Judicial Commissioner: (a) the Participant who has been charged with the alleged offence; (b) the person who lodged the Report (or, in the case of the ICC's Chief Executive Officer, his/her representative/nominee); and (c) a representative of the ICC's Legal Department. Where any such individual has a compelling justification for his/her non-attendance, then they shall be given the opportunity to participate in the hearing before the Judicial Commissioner by telephone or video conference (if available). Without prejudice to the Participant's ability to call and to question such witnesses as may be necessary and/or to be represented by such other person of his/her own choosing pursuant to Article 5.19, where the Participant charged is a Player or Player Support Personnel, one of the Team Captain, Team Vice-Captain or Team Manager of the team that the Player or Player Support Personnel represents may also attend such a hearing to provide additional support and assistance to the Player or Player Support Personnel.
- 5.19 Each of the individuals described in Article 5.18(a) and (b) shall have the right (at his/her or its own expense) to be represented at the hearing before the Judicial Commissioner by such representative (including legal counsel) of his/her or its own choosing. Where the person lodging the Report is an Umpire or Match Referee that officiated in the International Match in question or the ICC's Chief Executive Officer, then such person shall be entitled to be represented prior to, and during, the hearing (if he/she considers necessary) by a representative of the ICC's Legal Department.

- 5.110 The non-attendance of the Participant or his/her representative at the hearing, after proper notice of the hearing has been provided, shall not prevent the Judicial Commissioner from proceeding with the hearing in his/her absence, whether or not any written submissions are made on his/her behalf.
- 5.111 At the end of a hearing, where the Judicial Commissioner considers that further evidence is necessary or further time is required to consider the evidence that has been presented, he/she shall adjourn the hearing for an appropriate period of time and make such directions as may be necessary.
- 5.112 Alternatively, at the end of a hearing:
- 5.112.1 brought under Article 4.5.2:
- (a) as soon as possible after the conclusion of the hearing (and, in any event, no later than forty-eight (48) hours thereafter), the Judicial Commissioner will confirm the Participant's admission that he/she had committed an offence under the Anti-Discrimination Code and announce his/her decision in writing, with reasons, setting out: (a) what sanctions, if any, are to be imposed; (b) the date that any period of suspension shall come into force and effect; and (c) any rights of appeal that may exist pursuant to Article 8.
- 5.112.2 brought under Article 4.5.3 (or where the Participant has failed to respond in a timely fashion to the Notice of Charge):
- (a) the Judicial Commissioner shall adjourn the hearing (for a period of no less than ten (10) minutes and no more than twenty-four (24) hours), following which he/she will reconvene the hearing and verbally announce his/her finding as to whether an offence under the Anti-Discrimination Code has been committed;
 - (b) where the Judicial Commissioner determines that an offence under the Anti-Discrimination Code has been committed, the Participant may request a short adjournment (of no more than thirty (30) minutes) to prepare any submissions that he/she might wish to make in relation to the appropriate sanction that ought to be applied; and
 - (c) as soon as possible after the conclusion of the hearing (and, in any event, no later than forty-eight (48) hours thereafter), the Judicial Commissioner will announce his/her decision in writing, with reasons, setting out: (a) the finding as to whether an offence under the Anti-Discrimination Code had been committed; (b) what sanctions, if any, are to be imposed; (c) the date that any period of suspension shall come into force and effect; and (d) any rights of appeal that may exist pursuant to Article 8.

- 5.113 The Judicial Commissioner shall have the discretion to announce the substance of his/her decision prior to the issue of the written reasoned decision referred to in Article 5.112.
- 5.114 A copy of the written reasoned decision will be provided to the Participant, the CEO of the Player or Player Support Personnel's National Cricket Federation (where applicable) and the ICC's General Counsel).
- 5.115 Subject only to the rights of appeal under Article 8, the Judicial Commissioner's decision shall be the full, final and complete disposition of the matter and will be binding on all parties.

General Principles of Procedure

- 5.2 Where a Report is filed by more than one of the individuals described in Article 3.1 in relation to the same alleged offence under the Anti-Discrimination Code, then the Participant alleged to have committed the offence will only be served with one Notice of Charge in accordance with the procedures set out in Article 4. However, all persons who filed a Report (or, in the case of the ICC's Chief Executive, his/her representative/nominee) in relation to the alleged offence are required to attend the hearing before the Judicial Commissioner unless there is a compelling justification for his/her non-attendance, in which case they shall be given the opportunity to participate in the hearing by telephone or video conference (if available).
- 5.3 Where two or more Participants are alleged to have committed offences under the Anti-Discrimination Code, they may both be dealt with at the same hearing where the proceedings arise out of the same incident or set of facts, or where there is a clear link between separate incidents.
- 5.4 Where a Participant is alleged to have committed more than one breach of the Anti-Discrimination Code during, or in relation to, the same International Match, then all of the alleged offences may be dealt with at the same hearing.
- 5.5 Any failure or refusal by any Participant to provide assistance to a Judicial Commissioner in connection with any charge made pursuant to this Anti-Discrimination Code may constitute a separate offence (depending upon the seriousness and context of such failure or refusal) under Articles 2.1.8, 2.2.11, 2.3.3 or 2.4.3 of the Code of Conduct.
- 5.6 Where a Judicial Commissioner is, or becomes unwilling or unable to hear a case (for example, where he/she finds him/herself in a position of conflict), then the ICC's General Counsel shall have the discretion to appoint another member of the ICC's Code of Conduct Commission as a replacement to the Judicial Commissioner and all of the remaining procedure will apply accordingly.

- 5.7 The ICC will issue a public announcement regarding any decision of the Judicial Commissioner made under the Anti-Discrimination Code, as soon as is reasonably practicable after the decision has been communicated to the parties. The public announcement of the decision may include details of the offences committed under the Anti-Discrimination Code and of the sanctions imposed, if any. Until such time as a public announcement is published, all parties and participants in the proceedings shall treat such proceedings as strictly confidential. For the avoidance of doubt, nothing in this Article shall prevent any party (or any relevant National Cricket Federation) publicly confirming the date of the hearing, the offence that is alleged to have been committed and/or the name of the Participant charged.

ARTICLE 6 – STANDARD OF PROOF AND EVIDENCE

- 6.1 Unless otherwise described herein, the standard of proof in all cases brought under the Anti-Discrimination Code shall be whether the Judicial Commissioner is comfortably satisfied, bearing in mind the seriousness of the allegation that is made, that the alleged offence has been committed. This standard of proof in all cases shall be determined on a sliding scale from, at a minimum, a mere balance of probability (for the least serious offences) up to proof beyond a reasonable doubt (for the most serious offences).
- 6.2 The Judicial Commissioner shall not be bound by judicial rules governing the admissibility of evidence. Instead, facts relating to any alleged offence under the Anti-Discrimination Code may be established by any reliable means, including admissions. However, all statements, submissions and/or evidence made, heard or disclosed during any part of any conciliation process pursuant to Article 4.3, shall be so made, heard or disclosed strictly (unless the relevant party agrees) on a 'without prejudice' basis and used for the purposes of the conciliation process only. Accordingly, no such statements, submissions and/or evidence shall be adduced, given or accepted during any disciplinary hearing before the Judicial Commissioner without the express consent of the relevant party.
- 6.3 The Judicial Commissioner may draw an inference adverse to the Participant who is asserted to have committed an offence under the Anti-Discrimination Code based on his/her refusal, without compelling justification, after a request made in a reasonable time in advance of the hearing, to appear at the hearing (either in person or telephonically as directed by the Judicial Commissioner) and/or to answer any relevant questions.

ARTICLE 7 – SANCTIONS

- 7.1 Where a Judicial Commissioner determines that an offence under the Anti-Discrimination Code has been committed, he/she will be required to impose an appropriate sanction on the Participant.
- 7.2 In order to determine the appropriate sanction that is to be imposed in each case, the Judicial Commissioner must first consider whether the Participant has previously been found guilty of the same offence under the Anti-Discrimination Code or any predecessor regulations that may have applied (including the Anti-Racism Code and/or the Code of Conduct).
- 7.3 Once the Judicial Commissioner has established whether this is a repeat offence, then he/she shall go on to take into account any other factors that he/she deems relevant and appropriate to the mitigation or aggravation of the nature of the offence (including, without limitation, the nature and frequency of any previous offences under the Anti-Discrimination Code or any predecessor regulations) before determining, in accordance with the following table, what the appropriate sanction(s) should be:

RANGE OF PERMISSIBLE SANCTIONS (FIRST OFFENCE)	RANGE OF PERMISSIBLE SANCTIONS (SECOND OFFENCE)	RANGE OF PERMISSIBLE SANCTIONS (THIRD OFFENCE)
In the case of a Player or Player Support Personnel, the imposition of between four (4) and eight (8) Suspension Points.	In the case of a Player or Player Support Personnel, the imposition of between eight (8) Suspension Points and a lifetime's suspension.	In the case of a Player or Player Support Personnel, the imposition of a suspension of between one (1) year and a lifetime.
In the case of an Umpire, Match Referee or Umpire Support Personnel, a suspension of between one (1) and three (3) months during which period such Umpire, Match Referee or Umpire Support Personnel shall not officiate or otherwise participate in any Match.	In the case of an Umpire, Match Referee or Umpire Support Personnel, a suspension of between three (3) months and a lifetime during which period such Umpire, Match Referee or Umpire Support Personnel shall not officiate or otherwise participate in any Match.	In the case of an Umpire, Match Referee or Umpire Support Personnel, a suspension of between one (1) year and a lifetime during which period such Umpire, Match Referee or Umpire Support Personnel shall not officiate or otherwise participate in any Match.
<p>AND (in all cases)</p> <p>The mandatory requirement to undergo a programme of education/counselling designed to promote the understanding and awareness of issues directly relevant to the offence that the Participant has been determined to have committed.</p>		

- 7.4 Where a Judicial Commissioner imposes a period of suspension on any Player or Player Support Personnel, then, unless such period is for a fixed period of time (for example, one year) then, any such period of suspension shall be referenced by Suspension Points, which shall carry the following weightings:
 - 7.4.1 a Test Match or any other International Match of at least four days in duration is given a weighting of two (2) Suspension Points;
 - 7.4.2 a One Day International Match or Twenty20 International Match is given a weighting of one (1) Suspension Point; and
 - 7.4.3 all other International Matches are given a weighting of one (1) Suspension Point.
- 7.5 Where Suspension Points are imposed against a Player or Player Support Personnel, then such Suspension Points will be applied in accordance with the following principles:
 - 7.5.1 the Judicial Commissioner shall have regard to the Player's or Player Support Personnel's participation in the various formats of International Matches over the previous two years in order to determine (to the best of his/her ability) which of the forthcoming International Matches the Player is most likely to participate in or the Player Support Personnel is most likely to assist the participation of a Player in;
 - 7.5.2 where necessary, the Judicial Commissioner shall be entitled to consult with the ICC in order to make a determination as to which of the forthcoming International Matches the Player is most likely to participate in or the Player Support Personnel is most likely to assist the participation of a Player in;
 - 7.5.3 in so far as is reasonably possible, the Judicial Commissioner shall apply the Suspension Points to the subsequent International Matches in which the Player is most likely to participate in or the Player Support Personnel is most likely to assist the participation of a Player in, on a chronological basis immediately following the announcement of the decision;
 - 7.5.4 where a Player or Player Support Personnel has his/her Suspension Points applied to an International Match that is subsequently cancelled, postponed or otherwise abandoned prior to the actual day on which it is scheduled to take place, then such Suspension Points must be reallocated to the next subsequent International Matches in which the Player is most likely to participate in or the Player Support Personnel is most likely to assist the participation of a Player in. Where an International Match is cancelled, postponed or otherwise abandoned at any time on the actual day on which it is scheduled to take place, then the Suspension Points will remain allocated to that International Match, irrespective of such cancellation, postponement or abandonment.

EXAMPLE OF THE APPLICATION OF SUSPENSION POINTS:

- 1 Where a Player's playing history suggests that he/she is most likely to represent his National Cricket Federation in Test Matches only, then the Suspension Points shall be applied to his/her future participation in Test Matches only, so that six (6) Suspension Points would be applied to the three (3) Test Matches immediately following the announcement of the decision, notwithstanding that the National Cricket Federation might be participating in intervening One Day International Matches and/or Twenty20 International Matches.
- 2 Where a Player's playing history suggests that he/she is likely to be selected to represent his National Cricket Federation in all formats of International Matches, then the Suspension Points shall be applied to his/her future participation in all International Matches in the sequential order in which such International Matches take place immediately following the announcement of the decision. The examples set out below, would apply to the following chronological list of potential playing fixtures:
 - Code of Conduct decision
 - One-Day International Match - weighting 1 Suspension Point ("Match A")
 - One-Day International Match - weighting 1 Suspension Point ("Match B")
 - Test Match - weighting 2 Suspension Point ("Match C")
 - Test Match weighting 2 Suspension Point ("Match D")
 - Twenty20 International Match - weighting 1 Suspension Point ("Match E")
 - Twenty20 International Match - weighting 1 Suspension Point ("Match F")
 - (a) One (1) Suspension Point would be applied to Match A;
 - (b) Two (2) Suspension Points would be applied to Matches A and B;
 - (c) Three (3) Suspension Points would be applied to Matches A, B and E;
 - (d) Four (4) Suspension Point would be applied to Match A, B and C;
 - (e) Five (5) Suspension Points would be applied to Matches A, B, C and E;
 - (f) Six (6) Suspension Points would be applied to Matches A, B, C and D;
 - (g) Seven (7) Suspension Points would be applied to Matches A, B, C, D and E;
 - (h) Eight (8) Suspension Points would be applied to Matches A, B, C, D, E and F.

- 7.6 For the avoidance of any doubt:
 - 7.6.1 the Judicial Commissioner will have no jurisdiction to adjust, reverse or amend the results of any International Match;
 - 7.6.2 where a Participant is found guilty of committing two separate Anti-Discrimination Code offences that do not relate to the same incident or set of circumstances arising during an International Match and sanctioned separately for each offence, then any sanctions should run cumulatively (and not concurrently);
 - 7.6.3 where a Participant is found guilty of committing two Anti-Discrimination Code offences in relation to the same incident or set of circumstances during an International Match and sanctioned separately, then any sanctions imposed should run concurrently (and not cumulatively); and
 - 7.6.4 nothing in this Anti-Discrimination Code shall permit plea bargaining in relation to any alleged offence committed under this Anti-Discrimination Code.
- 7.7 Where a Participant has had Suspension Points imposed against him/her or has been suspended for a fixed period of time, he/she may not play, coach, officiate, support an Umpire or Match Referee or otherwise participate or be involved in any capacity in the International Match(es) which: (a) are covered by the application of his/her Suspension Points as determined in accordance with Article 7.5; or (b) take place during the fixed period of his/her suspension.
- 7.8 Once any period of suspension has expired, the Participant will automatically become re-eligible to participate (in the case of a Player) or assist a Player's participation (in the case of a Player Support Personnel) or officiate (in the case of an Umpire or Match Referee) or be appointed to support an Umpire or Match Referee (in the case of an Umpire Support Personnel) in International Matches provided that he/she has first: (a) completed the official programme of education/counselling to the reasonable satisfaction of the relevant programme organiser or demonstrated that he/she continues to fully participate in such programme; and (b) satisfied, in full, any award of costs made against him/her by any Appeal Panel pursuant to Article 8.3.5.

ARTICLE 8 – APPEALS

- 8.1 Decisions made under the Anti-Discrimination Code by a Judicial Commissioner may be challenged solely by appeal as set out in Article 8. Such decisions shall remain in effect while under appeal unless any Appeal Panel properly convened to hear the appeal orders otherwise.
- 8.2 The only parties who may appeal a decision made under the Anti-Discrimination Code shall be: (a) the Participant found guilty of the offence; and (b) the ICC’s Chief Executive Officer.
- 8.3 Any notice to appeal under this Article must be lodged with the ICC’s General Counsel within seven (7) days of receipt of the written decision of the Judicial Commissioner. In all cases, a copy of such notice will also be provided to the CEO of the National Cricket Federation to which the Participant is affiliated. Thereafter, the following will apply:
 - 8.3.1 Within forty-eight (48) hours of receipt of a notice to appeal: (a) the ICC’s General Counsel will appoint three members of the ICC’s Code of Conduct Commission each of whom are (unless otherwise agreed between the parties) from a country other than those participating in the relevant International Match or the country of the Umpire, Match Referee or Umpire Support Personnel to sit as the Appeal Panel to hear the appeal; and (b) the Judicial Commissioner will provide a written statement to the ICC’s General Counsel setting out any relevant facts (to be copied to the Player or Player Support Personnel).
 - 8.3.2 The provisions of Articles 5.1.2 to 5.1.14, applicable to proceedings before the Judicial Commissioner, shall apply mutatis mutandis (ie with changes deemed to have been made as required to reflect the different context) to appeal hearings before the Appeal Panel.
 - 8.3.3 The Appeal Panel shall hear and determine all issues arising from any matter which is appealed to it pursuant to this Article on a de novo basis, ie it shall hear the matter over again, from the beginning, without being bound in any way by the decision being appealed. For the avoidance of doubt, the Appeal Panel shall have the power to increase or decrease, amend or otherwise substitute a new decision on the appropriateness (or otherwise) of the sanction imposed at first instance, provided that any new sanction must be within the permitted range of sanctions set out in the table in Article 7.3.
 - 8.3.4 Appeal hearings pursuant to this Article 8 should be completed expeditiously. Save where all parties agree or fairness requires otherwise, the appeal hearing shall be commenced no later than thirty (30) days after the appointment of the Appeal Panel.
 - 8.3.5 The Appeal Panel shall have the power to order some or all of the costs of the appeal proceedings (including the costs of holding the hearing, any interpretation costs, the legal and/or travel/ accommodation costs of the Appeal Panel and/or any other relevant parties) to be paid by the appealing party if it considers that such party has acted, spuriously, frivolously or otherwise in bad faith.
 - 8.3.6 Any decision made by the Appeal Panel under this Article 8, shall be the full, final and complete disposition of the matter and will be binding on all parties.

ARTICLE 9 – RECOGNITION OF DECISIONS

- 9.1 Any hearing results or other final adjudications under the Anti-Discrimination Code shall be recognised and respected by the ICC and its National Cricket Federations automatically upon receipt of notice of the same, without the need for any further formality. Each of the ICC and its National Cricket Federations shall take all steps legally available to it to enforce and give effect to such decisions.
- 9.2 It shall be a condition of membership of the ICC that all National Cricket Federations shall comply with the Anti-Discrimination Code.

ARTICLE 10 – AMENDMENT AND INTERPRETATION OF THE ANTI-DISCRIMINATION CODE

- 10.1 The Anti-Discrimination Code may be amended from time to time by the ICC, with such amendments coming into effect on the date specified by the ICC.
- 10.2 The Anti-Discrimination Code shall be interpreted as an independent and autonomous text and not by reference to existing law or statutes of any National Cricket Federation or government.
- 10.3 The headings used for the various Articles of the Anti-Discrimination Code are for the purpose of guidance only and shall not be deemed to be part of the substance of the Anti-Discrimination Code or to inform or affect in any way the language of the provisions to which they refer.
- 10.4 The Anti-Discrimination Code shall come into full force and effect on 1 August 2019 (the “Effective Date”). It shall not apply retrospectively to matters pending before the Effective Date; provided, however, that any case pending prior to the Effective Date, or brought after the Effective Date but based on an offence that is alleged to have occurred before the Effective Date, shall be governed by the predecessor version of the Anti-Discrimination Code (or the Anti-Racism Code as applicable) in force at the time of the alleged offence, subject to any application of the principle of *lex mitior* by the hearing panel determining the case.
- 10.5 If any Article or provision of this Anti-Discrimination Code is held invalid, unenforceable or illegal for any reason, the Anti-Discrimination Code shall remain otherwise in full force apart from such Article or provision which shall be deemed deleted insofar as it is invalid, unenforceable or illegal.
- 10.6 The Anti-Discrimination Code is governed by and shall be construed in accordance with English law. Strictly without prejudice to the arbitration provisions of Articles 5 and 8 of the Anti-Discrimination Code, disputes relating to the Anti-Discrimination Code shall be subject to the exclusive jurisdiction of the English courts.

APPENDIX 1

DEFINITIONS

Appeal Panel. A panel of three persons appointed by the ICC from the members of the ICC Code of Conduct Commission, to perform the functions assigned to the Appeal Panel under the Anti-Discrimination Code. Each member of the Appeal Panel shall be independent of the ICC, which may provide reasonable compensation and reimbursement of expenses to such members.

Anti-Racism Code. The ICC's Anti-Racism Code for Participants, as it was in force from time to time, being the predecessor version of the Anti-Discrimination Code.

Code of Conduct. The ICC's Code of Conduct for Players and Player Support Personnel, as amended from time to time.

Conciliator. An independent expert, trained in mediation and, where possible, with specialist expertise in the area of race relations (or such other expertise as may be relevant to the nature of any alleged offence), who is appointed by the ICC to perform the functions assigned to the Conciliator under the Anti-Discrimination Code.

Effective Date. As defined in Article 10.4.

ICC. The International Cricket Council or its designee.

ICC's Anti-Discrimination Policy for International Cricket. The ICC's Anti-Discrimination Policy for International Cricket, as amended from time to time.

ICC's Chief Executive Officer. The person appointed by the ICC from time to time to act as its Chief Executive Officer (or his/her designee).

ICC's Classification of Official Cricket. The ICC's Official Classification of Official Cricket, as amended from time to time.

ICC Code of Conduct Commission. An official committee of the ICC established, amongst other things, to provide independent enquiries, investigations and rulings in relation to matters brought to its attention pursuant to the Code of Conduct and/or Anti-Discrimination Code. Each member of the ICC Code of Conduct Commission shall be independent of the ICC, which may provide reasonable compensation and reimbursement of expenses to such members.

ICC Events. Means each of the following, and each match played as part of the following (men's and women's, as applicable): (a) the ICC Cricket World Cup, together with any qualifying events thereto; (b) the ICC Twenty20 World Cup, together with any qualifying events thereto; (c) the ICC Men's World Test Championship Final, (d) the ICC Under 19 Cricket World Cup, together with any qualifying events thereto; (e) the ICC Intercontinental Cup; (f) any successor to or replacement for any of the foregoing events, as specified by the ICC and (g) any other match or event organised or sanctioned by the ICC from time to time to which the ICC deems it appropriate that the Anti-Discrimination Code should apply.

ICC's General Counsel. The person appointed by the ICC from time to time to act as the ICC's General Counsel (or his/her designee).

ICC's Senior Manager - Umpires and Referees. The person appointed by the ICC from time to time to act as the ICC's Senior Manager - Umpires and Referees (or his/her designee).

International Match. Each of the following (in men's and women's cricket): (a) any Test Match, One Day International Match or Twenty20 International Match; (b) any Match played as part of an ICC Event; (c) any International Tour Match; or (d) any other Match organised or sanctioned by the ICC from time to time to which the ICC deems it appropriate that the Anti-Discrimination Code should apply.

International Tour Match. Any cricket match of any format and duration in length played between a representative team of a National Cricket Federation and any domestic, guest or invitational team.

Judicial Commissioner. The independent person appointed by the ICC from the ICC Code of Conduct Commission, to perform the functions assigned to the Judicial Commissioner under the Anti-Discrimination Code.

Match. A cricket match of any format and duration in length played between representative teams (male or female) of two National Cricket Federations affiliated to the ICC.

Match Referee. The independent person appointed by the ICC (or any other relevant party) as the official match referee for a designated International Match, whether such Match Referee carries out his/her functions remotely or otherwise. Where a Match Referee is not physically present at a particular Match, he/she may be assisted in the administrative performance of his/her duties under this Anti-Discrimination Code by any official 'Match Manager' who may be appointed to officiate at such International Match.

National Cricket Federation. A national or regional entity which is a member of or is recognised by the ICC as the entity governing the sport of cricket in a country (or collective group of countries associated for cricket purposes).

Notice of Charge. As defined in Article 4.4.

One Day International Match. As defined by the ICC Classification of Official Cricket.

Participant. Any Player, Player Support Personnel, Umpire, Match Referee or Umpire Support Personnel.

Player. Any cricketer who is selected in any playing or touring team or squad that is chosen to represent a National Cricket Federation in any International Match or series of International Matches.

Player Support Personnel. Any coach, trainer, manager, selector, team official, doctor, physiotherapist or any other person employed by, representing or otherwise affiliated to a playing/ touring team or squad that is chosen to represent a National Cricket Federation in any International Match or series of International Matches.

Report. As defined in Article 3.1.

Suspension Points. The weighting points used to determine the period of suspension imposed against any Player or Player Support Personnel pursuant to Article 7 of the Anti-Discrimination Code.

Team Captain or Vice Captain. The official captain or vice-captain of any team participating in a Match.

Team Manager. The official manager of any team participating in a Match, or, where a team does not have an official manager, the person fulfilling the functions of the team manager.

Test Match. As defined by the ICC Classification of Official Cricket.

Twenty20 International Match. As defined by the ICC Classification of Official Cricket.

Umpire. Any umpire (including any on-field umpire, television umpire, third or fourth umpire) appointed to officiate in any Match.

Umpire Support Personnel. Any technical officials (for example, and without limitation, any official with responsibility for operating the communication equipment for Umpires and Match Referees during a Match) or umpire coaches appointed (by the ICC or any other relevant party) to support the Umpires and/or Match Referees in their appointments to any Match or any other person appointed by the ICC to support Umpires and Match Referees.

APPENDIX 2

EXPEDITED PROCEDURE FOR OFFENCES UNDER THE ANTI-RACISM CODE OCCURRING DURING AN ICC EVENT

Where an offence under the Anti-Discrimination Code is alleged to have occurred during, or in relation to, an International Match that is played as part of an ICC Event (except the ICC Intercontinental Cup or the ICC World Cricket League Championship in which no expedited procedure is to be applied), the provisions of the Anti-Discrimination Code shall apply in full save for the amendments described in this Appendix 2, which are deemed to be made in order to ensure that any matters arising can be dealt with expeditiously:

ARTICLE 3 – REPORTING AN ALLEGED OFFENCE UNDER THE ANTI-DISCRIMINATION CODE

- Article 3.2 - “seven (7) days” is replaced with “thirty-six (36) hours”.

ARTICLE 4 – NOTIFICATION PROCEDURE

- Article 4.1 - “five (5) business days” is replaced with “forty-eight (48) hours”.

ARTICLE 5 – THE DISCIPLINARY PROCEDURE

- Article 5.1 is replaced in its entirety with the following:

5.1 Disciplinary Procedure during an ICC Event

Where a matter proceeds to a hearing under Article 4.5.2 or 4.5.3, then the case shall be referred to a Judicial Commissioner for adjudication in accordance with the following procedure:

- 5.1.1 As soon as reasonably possible, the ICC shall appoint one member from the ICC’s Code of Conduct Commission to sit as the Judicial Commissioner to hear the case sitting alone. The appointed member shall be independent of the parties, have had no prior involvement with the case and shall not, unless otherwise agreed between the parties, be from a country participating in the International Match during, or in relation to which, the alleged offence was committed.
- 5.1.2 Subject to the discretion of the Judicial Commissioner to order otherwise for good cause shown by the Participant, the hearing will take place at the time specified in the Notice of Charge (which should, in the absence of exceptional circumstances, be no more than forty-eight (48) hours after receipt by the Participant of the Notice of Charge) and in the country in which the alleged offence was committed. For the avoidance of doubt, nothing in this Article 5.1.2 prevents a hearing from being convened at a time during which the International Match during which the alleged offence took place, remains in progress.

- 5.13 The procedure followed at the hearing shall be at the discretion of the Judicial Commissioner, provided that the hearing is conducted in a manner which offers the Participant with a fair and reasonable opportunity to present evidence (including the right to call and to question witnesses by telephone or video-conference where necessary), address the Judicial Commissioner and present his/her case. For the avoidance of any doubt, in accordance with Article 6.2, unless the relevant party agrees otherwise, no evidence shall be adduced, given or accepted during any hearing before the Judicial Commissioner in relation to anything that may have been said or disclosed during any part of any 'without prejudice' conciliation process carried out pursuant to Article 4.3.
- 5.14 The hearing before the Judicial Commissioner shall be in English, and certified English translations shall be submitted of any non-English documents put before the Judicial Commissioner. The cost of the translation shall be borne by the party offering the document(s). If required by the Judicial Commissioner (at his/her discretion), the ICC shall make arrangements to have the hearing recorded or transcribed. If requested by the Participant, the ICC shall also arrange for an interpreter to attend the hearing. Such costs of transcription and interpretation shall be paid by the ICC.
- 5.15 Where video evidence of the alleged offence is available at the hearing before the Judicial Commissioner, then it may be relied upon by any party, provided that all other parties shall have the right to make such representations in relation to it that they may see fit.
- 5.16 Unless exceptional circumstances apply, each of the following individuals must attend any hearing before the Judicial Commissioner: (a) the Participant who has been charged with the alleged offence; (b) the person who lodged the Report (or, in the case of the ICC's Chief Executive Officer, his/her representative/nominee); and (c) a representative of the ICC's Legal Department. Where any such individual has a compelling justification for his/her non-attendance, then they shall be given the opportunity to participate in the hearing before the Judicial Commissioner by telephone or video conference (if available). Without prejudice to the Participant's ability to call and to question such witnesses as may be necessary and/or to be represented by such other person of his/her own choosing pursuant to Article 5.17, where the Participant charged is a Player or Player Support Personnel, one of the Captain, Vice-Captain or Team Manager of the team that the Player or Player Support Personnel represents may also attend a hearing before the Judicial Commissioner to provide additional support and assistance to the Player or Player Support Personnel.
- 5.17 Each of the individuals described in Article 5.16(a) and (b) shall have the right (at his/her or its own expense) to be represented at the hearing before the Judicial Commissioner by such representative (including legal counsel) of his/her or its own choosing. Where the person lodging the Report is an Umpire or Match Referee that officiated in the International Match in question or the ICC's Chief Executive Officer, then such person shall be entitled to be represented prior to, and during, the hearing (if he/she considers necessary) by a representative of the ICC's Legal Department.

- 5.18 The non-attendance of the Participant or his/her representative at the hearing, after proper notice of the hearing has been provided, shall not prevent the Judicial Commissioner from proceeding with the hearing in his/her absence, whether or not any written submissions are made on his/her behalf.
- 5.19 At the end of a hearing, where the Judicial Commissioner considers that further evidence is necessary or further time is required to consider the evidence that has been presented, he/she shall adjourn the hearing for an appropriate period of time and make such directions as may be necessary.
- 5.110 Alternatively, at the end of a hearing:
- 5.110.1 brought under Article 4.5.2:
- (a) as soon as possible after the conclusion of the hearing (and, in any event, no later than twenty-four (24) hours thereafter), the Judicial Commissioner will confirm the Participant's admission that he/she had committed an offence under the Anti-Discrimination Code and announce his/her decision in writing, with reasons, setting out: (a) what sanctions, if any, are to be imposed; (b) the date that any period of suspension shall come into force and effect; and (c) any rights of appeal that may exist pursuant to Article 8.
- 5.110.2 brought under Article 4.5.3 (or where the Participant has failed to respond in a timely fashion to the Notice of Charge):
- (a) the Judicial Commissioner shall adjourn the hearing (for a period of no less than ten (10) minutes and no more than two (2) hours), following which he/she will reconvene the hearing and verbally announce his/her finding as to whether an offence under the Anti-Discrimination Code has been committed;
- (b) where the Judicial Commissioner determines that an offence under the Anti-Discrimination Code has been committed, the Participant may request a short adjournment (of no more than thirty (30) minutes) to prepare any submissions that he/she might wish to make in relation to the appropriate sanction that ought to be applied; and
- (c) as soon as possible after the conclusion of the hearing (and, in any event, no later than twenty-four (24) hours thereafter), the Judicial Commissioner will announce his/her decision in writing, with reasons, setting out: (a) the finding as to whether an offence under the Anti-Discrimination Code had been committed; (b) what sanctions, if any, are to be imposed; (c) the date that any period of suspension shall come into force and effect; and (d) any rights of appeal that may exist pursuant to Article 8.

- 5.111 The Judicial Commissioner shall have the discretion to announce the substance of his/her decision prior to the issue of the written reasoned decision referred to in Article 5.110.
- 5.112 A copy of the written reasoned decision will be provided to the Participant, where applicable, the CEO of the Player or Player Support Personnel's National Cricket Federation and the ICC's General Counsel .
- 5.113 Subject only to the rights of appeal under Article 8, the Judicial Commissioner's decision shall be the full, final and complete disposition of the matter and will be binding on all parties.

ARTICLE 8 – APPEALS

- Article 8.3 – “seven (7) days” is replaced with “forty-eight (48) hours”.
- Article 8.3.1 – “forty-eight (48) hours” is replaced with “twenty-four (24) hours”.
- Article 8.3.4 – “thirty (30) days” is replaced with “seventy-two (72) hours”.

ICC ANTI-DOPING CODE

ICC ANTI-DOPING CODE

The ICC has a zero-tolerance approach to doping in cricket in support of its continued efforts to: (a) maintain the integrity of the sport of cricket; (b) protect the health and rights of all participants in the sport of cricket; and (c) keep the sport of cricket free from doping.

Consistent with the WADA Code, the ICC's Anti-Doping Code (the '**Code**') ensures cricket plays its part in the global fight against drugs in sport. All international cricketers (as defined in the Code) are bound by the Code and are required to sign a Consent and Agreement form acknowledging that the Code applies to them.

Under the Code, all international cricketers can be subject to both In and Out-of-Competition testing by the ICC any day, anytime, 365 days of the year.

Whilst it remains the responsibility of each National Cricket Federation to educate their own international cricketers in all aspects of anti-doping and to ensure that such cricketers are aware of the Code and that it applies to them, it is ultimately each cricketer's **personal responsibility** to:

- 1 acquaint him/herself, and ensure that each person from whom he/she takes advice (including medical personnel) is acquainted with all of the requirements of the Code;
- 2 know what constitutes an anti-doping rule violation under the Code and what substances and methods have been included on the Prohibited List;
- 3 ensure that anything he/she ingests or uses, as well as any medical treatment he/she receives, does not give rise to an anti-doping rule violation under the Code; and
- 4 make him/herself available upon request for Testing, both In-Competition and Out-of-Competition.
- 5 comply with the ICC's Whereabouts Requirements for Out-of-Competition Testing (a copy of which can be found in the anti-doping section of the ICC's website: www.icc-cricket.com) where applicable, including by filing and maintaining accurate and relevant up-to-date information as required.

The full version of the ICC's Anti-Doping Code can be found in the anti-doping section of the ICC's website: www.icc-cricket.com and all players are strongly recommended to review the Code in its entirety. In addition, the ICC has also developed numerous guidance notes, educational materials and documentation, all of which are also available on the website.

Finally, if any player, player support personnel or National Cricket Federation has any questions, concerns or comments in relation to any aspect of anti-doping, including the Code, then they should contact the ICC's Anti-Doping team on the following details:

ICC Anti-Doping

Telephone: + 971 4 382 8800 (office hours, + 4 GMT)

Mobile: + 971 50 554 5891 (24 hours)

E-mail: anti-doping@icc-cricket.com (confidential)

ICC ANTI-CORRUPTION CODE FOR PARTICIPANTS

ICC ANTI-CORRUPTION CODE FOR PARTICIPANTS

CONTENTS

ARTICLE 1	INTRODUCTION, SCOPE AND APPLICATION	17.2
ARTICLE 2	OFFENCES UNDER THE ANTI-CORRUPTION CODE	17.7
ARTICLE 3	STANDARD OF PROOF AND EVIDENCE	17.12
ARTICLE 4	INVESTIGATIONS AND NOTICE OF CHARGE	17.12
ARTICLE 5	THE DISCIPLINARY PROCESS	17.17
ARTICLE 6	SANCTIONS	17.21
ARTICLE 7	APPEALS	17.25
ARTICLE 8	PUBLIC DISCLOSURE AND CONFIDENTIALITY	17.26
ARTICLE 9	RECOGNITION OF DECISIONS	17.26
ARTICLE 10	STATUTE OF LIMITATIONS	17.27
ARTICLE 11	AMENDMENT AND INTERPRETATION OF THE ANTI-CORRUPTION CODE	17.27
APPENDIX 1	DEFINITIONS	17.28

For information regarding the ICC Anti-Corruption Code, please contact:

The ICC's Anti-Corruption Unit
International Cricket Council
PO Box 500 070
Dubai, United Arab Emirates

Tel (switchboard): +971 4 382 8800

Confidential anti-corruption direct line: +971 4 341 7225

Confidential anti-corruption facsimile: +971 4 340 4856

Confidential anti-corruption e-mail: contactACU@icc-cricket.com

ARTICLE 1 – INTRODUCTION, SCOPE AND APPLICATION

- 1.1 The ICC has adopted this Anti-Corruption Code in recognition of the following fundamental sporting imperatives:
- 1.1.1 All cricket matches are to be contested on a level playing-field, with the outcome to be determined solely by the respective merits of the competing teams and to remain uncertain until the cricket match is completed. This is the essential characteristic that gives sport its unique appeal.
- 1.1.2 Public confidence in the authenticity and integrity of the sporting contest is therefore vital. If that confidence is undermined, then the very essence of cricket will be shaken to the core.
- 1.1.3 Advancing technology and increasing popularity have led to a substantial increase in the amount, and the sophistication, of betting on cricket matches. The development of new betting products, including spread-betting and betting exchanges, as well as internet and phone accounts that allow people to place a bet at any time and from any place, even after a cricket match has started, have all increased the potential for the development of corrupt betting practices. That, in turn, increases the risk that attempts will be made to involve Participants in such practices. This can create a perception that the integrity of the sport is under threat.
- 1.1.4 Furthermore, it is of the nature of this type of misconduct that it is carried out under cover and in secret, thereby creating significant challenges for the ICC in the enforcement of rules of conduct. As a consequence, the ICC needs to be empowered to seek information from and share information with competent authorities and other relevant third parties, and to require Participants to cooperate fully with all investigations and requests for information.
- 1.1.5 The ICC is committed to taking every step in its power (a) to prevent corrupt practices undermining the integrity of the sport of cricket, including any efforts to influence improperly the outcome or any other aspect of any Match; and (b) to preserve public confidence in the readiness, willingness and ability of the ICC and its National Cricket Federations to protect the sport from such corrupt practices.
- 1.2 The Anti-Corruption Code is to be interpreted and applied by reference to the fundamental sporting imperatives described in Article 1.1 (including, without limitation, where an issue arises that is not expressly addressed in the Anti-Corruption Code). Such interpretation and application shall take precedence over any strict legal or technical interpretations of the Anti-Corruption Code that may otherwise be proposed.
- 1.3 Unless otherwise indicated, references in the Anti-Corruption Code to Articles and Appendices are to articles and appendices of the Anti-Corruption Code. Words in italicised text in the Anti-Corruption Code are defined terms. Unless set out in the Articles below, their respective definitions are set out in Appendix 1.

- 1.4 This Anti-Corruption Code applies to all Participants. For these purposes, a **“Participant”** is:
- 1.4.1 any cricketer who:
- 1.4.1.1 is selected (or who has been selected in the preceding twenty-four (24) months) to participate in an International Match and/or a Domestic Match for any playing or touring club, team or squad that is a member of, affiliated to, or otherwise falls within the jurisdiction of, a National Cricket Federation; and/or
- 1.4.1.2 is subject to an unexpired period of Ineligibility imposed on him/her pursuant to this Anti-Corruption Code and/or any anti-corruption rules of any National Cricket Federation (a **“Player”**); and/or
- 1.4.2 any coach, trainer, manager, selector, team owner or official, doctor, physiotherapist or any other person who:
- 1.4.2.1 is employed by, represents or is otherwise affiliated to (or who has been employed by, has represented or has been otherwise affiliated to in the preceding twenty-four (24) months) a team that participates in International Matches and/or a playing or touring club, team or squad that participates in Domestic Matches and is a member of, affiliated to, or otherwise falls within the jurisdiction of, a National Cricket Federation; and/or
- 1.4.2.2 is subject to an unexpired period of Ineligibility imposed on him/her pursuant to this Anti-Corruption Code and/or any anti-corruption rules of any National Cricket Federation (a **“Player Support Personnel”**); and/or
- 1.4.3 any ICC Official, Match Referee, Pitch Curator, Player Agent, Umpire or Umpire Support Personnel
- NOTE:** For the avoidance of doubt, the ICC’s jurisdiction to take action against a Participant under this Anti-Corruption Code is limited, subject to the provisions of Article 1.7 below, to Corrupt Conduct taking place in, or in relation to, International Matches.
- 1.5 Each Participant is automatically bound by this Anti-Corruption Code as soon as he/she becomes a Participant. From that point, he/she shall be deemed to have agreed:
- 1.5.1 not to engage in Corrupt Conduct in respect of any International Match, wherever it is held and whether or not he/she is personally participating or involved in any way in it;
- 1.5.2 that it is his/her personal responsibility to familiarise him/herself with all of the requirements of the Anti-Corruption Code, and to comply with those requirements (where applicable);

- 1.5.3 to submit to the jurisdiction of the ICC to investigate apparent or suspected Corrupt Conduct that would amount to a violation of the Anti-Corruption Code;
 - 1.5.4 to submit to the jurisdiction of any Anti-Corruption Tribunal convened under the Anti-Corruption Code to hear and determine, (a) any allegation by the ICC that the Participant has committed Corrupt Conduct under the Anti-Corruption Code; and (b) any related issue (e.g., any challenge to the validity of the charges or to the jurisdiction of the ICC or the Anti-Corruption Tribunal, as applicable);
 - 1.5.5 to submit to the exclusive jurisdiction of the CAS to hear and determine appeals made pursuant to this Anti-Corruption Code;
 - 1.5.6 not to bring any proceedings in any court or other forum that are inconsistent with the foregoing submissions to the jurisdiction of the aforementioned tribunals and the CAS;
 - 1.5.7 for purposes of applicable data protection and other laws and for all other purposes, to the collection, processing, disclosure and use of information relating to him/herself and his/her activities, including personal information relating to him/herself and his/her activities, to the extent expressly permitted under the terms of the Anti-Corruption Code (and that he/she shall confirm such agreement in writing upon demand); and
 - 1.5.8 to waive and forfeit any rights, defences and privileges provided by any law in any jurisdiction to withhold, or reject the provision of, information requested by the ACU General Manager in a Demand.
- 1.6** Without prejudice to Article 1.5, a Participant shall also be bound by all National Cricket Federations' anti-corruption rules:
- 1.6.1 not to commit Corrupt Conduct as set out under those rules; and
 - 1.6.2 to submit to the jurisdiction of first instance and appeal hearing panels convened under those rules to hear and determine allegations of breach of such rules and related issues.

NOTE: Copies of the anti-corruption rules of the National Cricket Federations and this Anti-Corruption Code can be found on the ICC Website. The substance of each set of anti-corruption rules (including what constitutes Corrupt Conduct and the sanctions for such Corrupt Conduct) of National Cricket Federations is materially the same as this Anti-Corruption Code.

1.7 For the avoidance of any doubt:

- 1.7.1 Where a Participant's alleged Corrupt Conduct would amount solely to a violation of this Anti-Corruption Code (whether such Corrupt Conduct actually relates to an International Match or not), the ICC will have the exclusive right to take action against the Participant under this Anti-Corruption Code for such Corrupt Conduct;

- 1.7.2 Where a Participant's alleged Corrupt Conduct would amount solely to a violation of the anti-corruption rules of a National Cricket Federation (whether such Corrupt Conduct actually relates to a Domestic Match or not), the relevant National Cricket Federation will have the exclusive right to take action against the Participant under its own anti-corruption rules.
- 1.7.3 Where a Participant's alleged Corrupt Conduct would amount to a violation of (a) this Anti-Corruption Code and one or more of the anti-corruption rules of any National Cricket Federation or (b) two or more of the anti-corruption rules of any National Cricket Federation:
 - 1.7.3.1 if the alleged Corrupt Conduct relates solely to one or more International Matches (other than International Tour Matches), the ICC will have the exclusive right to take action against the Participant under this Anti-Corruption Code for such Corrupt Conduct;
 - 1.7.3.2 if the alleged Corrupt Conduct relates solely to one or more International Tour Matches, then, unless otherwise agreed between the ICC and the relevant National Cricket Federation(s):
 - 1.7.3.2.1 the ICC will have the priority right and responsibility to take action under this Anti-Corruption Code against any Participant who participated on behalf of, or who was in any way associated with, or whose Corrupt Conduct was related to, the participating representative team of a Full Member (or Associate Member with Test and/or ODI or T20I Status) in the International Tour Match;
 - 1.7.3.2.2 the National Cricket Federation in whose jurisdiction the match(es) was/were played will have the priority right and responsibility to take action under its anti-corruption rules against any Participant who participated on behalf of, or who was in any way associated with, or whose Corrupt Conduct was related to, the participating domestic, guest or invitational team in the International Tour Match;
 - 1.7.3.3 if the alleged Corrupt Conduct relates to one or more International Matches and one or more Domestic Matches, the ICC and the relevant National Cricket Federation(s) shall agree between them which of them shall take action (and, where applicable, in which order) against any relevant Participant for such Corrupt Conduct and, in the absence of agreement, the ICC shall take action solely with respect to Corrupt Conduct relating to the relevant International Matches and the National Cricket Federation(s) shall take action solely with respect to Corrupt Conduct relating to the relevant Domestic Matches;

- 1.7.3.4 if the alleged Corrupt Conduct relates solely to one or more Domestic Matches, the National Cricket Federation in whose jurisdiction the Domestic Match(es) was/were played will have the priority right and responsibility to take action under its anti-corruption rules against any relevant Participant for such Corrupt Conduct (irrespective of the nationality or place of residence of the Participant), but where it fails to take any action under its anti-corruption rules within 180 days of becoming aware of the Corrupt Conduct or agrees to defer to the National Cricket Federation to which the Participant is affiliated, the National Cricket Federation to which the Participant is affiliated may instead take action against the Participant in respect of such Corrupt Conduct under its anti-corruption rules provided it has first given notice in writing of such to the National Cricket Federation in whose jurisdiction the Domestic Match(es) was/were played;
- 1.7.3.5 if the alleged Corrupt Conduct relates to an offence under any of Article 2.4 of the Anti-Corruption Code (or any analogous provision in the anti-corruption rules of any National Cricket Federation) and does not in any way relate to either an International Match or a Domestic Match, the ICC and the relevant National Cricket Federation(s) shall agree between them which of them shall take action (and, where applicable, in which order) against any relevant Participant for such Corrupt Conduct provided, however, that in the absence of agreement, the ICC shall not take action with respect to the relevant Corrupt Conduct unless the relevant Participant has played in an International Match in the previous twelve (12) months prior to the date the alleged offence was committed.
- 1.8 Where the ICC and/or any relevant National Cricket Federation agree between them, in accordance with the principles described in Article 1.7, above, that in any particular circumstances it would be more appropriate for:
- 1.8.1 the ICC to take action under the Anti-Corruption Code in relation to any Corrupt Conduct relating to one or more Domestic Matches and one or more International Matches, then all references in the Anti-Corruption Code to 'International Match' shall be deemed to be extended to include the relevant 'Domestic Match'; or
- 1.8.2 any relevant National Cricket Federation to take action under its own anti-corruption rules in relation to any Corrupt Conduct relating to one or more International Matches and one or more Domestic Matches played within the jurisdiction of another National Cricket Federation, then all references in its own anti-corruption rules to 'Domestic Matches' shall be deemed to be extended to include the relevant 'International Match' or such other relevant 'Domestic Match'.

- 1.9 Each Participant shall continue to be bound by and required to comply with the Anti-Corruption Code until he/she no longer qualifies as a Participant (the "End Date"). Notwithstanding the foregoing, the ICC shall continue to have jurisdiction over him/her under the Anti-Corruption Code after the End Date in respect of matters taking place prior to the End Date; and he/she shall continue to be bound by and required to comply with this Anti-Corruption Code after the End Date with respect to the investigation, prosecution and adjudication of such matters.
- 1.10 Without prejudice to any of the foregoing, the ICC (through the ACU) and the National Cricket Federations shall be responsible for promoting awareness of and education regarding the Anti-Corruption Code amongst all Participants.
- 1.11 This Anti-Corruption Code and the anti-corruption rules of the National Cricket Federations are not criminal laws but rather disciplinary rules of professional conduct for those involved in the sport of cricket. However, Corrupt Conduct may also be a criminal offence and/or a breach of other applicable laws or regulations. The Anti-Corruption Code is intended to supplement such laws and regulations. It is not intended, and should not be interpreted, construed or applied, to prejudice or undermine in any way the application of such laws and regulations. Participants must comply with all applicable laws and regulations at all times.
- 1.12 For the avoidance of any doubt, nothing in this Anti-Corruption Code is intended in any way:
- 1.12.1 to replace or amend the ICC's Policy on Member Associations with Betting Companies, which shall remain in full force and effect and binding at all times on all relevant parties;
- 1.12.2 to replace or amend the ICC's Minimum Standards for Players and Match Officials Area which shall remain in full force and effect and binding at all times on all relevant parties;
- 1.12.3 to replace or amend the ICC's Clothing and Equipment Rules and Regulations, which shall remain in full force and effect and binding at all times on all relevant parties.

ARTICLE 2– OFFENCES UNDER THE ANTI-CORRUPTION CODE

The conduct described in the sub-Articles set out in Articles 2.1 – 2.4, if committed by a Participant, shall amount to an offence by such Participant under this Anti-Corruption Code:

- 2.1 **Corruption:**
- 2.1.1 Fixing or contriving in any way or otherwise influencing improperly, or being a party to any agreement or effort to fix or contrive in any way or otherwise influence improperly, the result, progress, conduct or any other aspect of any International Match, including (without limitation) by deliberately underperforming therein.

NOTE: It shall not be an offence under Article 2.1.1 to manipulate International Matches for strategic or tactical reasons (such as where a Player performs in a certain manner to enable his team to lose a pool Match in an ICC Event in order to affect the standings of other teams in that ICC Event). Instead, such conduct is prohibited under the ICC's Code of Conduct for Players and Player Support Personnel and must be dealt with according to the procedures set out therein.

- 2.1.2 Ensuring for Betting or other corrupt purposes the occurrence of a particular incident in an International Match.
- 2.1.3 Seeking, accepting, offering or agreeing to accept any bribe or other Reward to: (a) fix or to contrive in any way or otherwise to influence improperly the result, progress, conduct or any other aspect of any International Match; or (b) ensure for Betting or other corrupt purposes the occurrence of a particular incident in an International Match.
- 2.1.4 Directly or indirectly soliciting, inducing, enticing, instructing, persuading, encouraging or intentionally facilitating any Participant to breach any of the foregoing provisions of this Article 2.1.

2.2 Betting:

- 2.2.1 Placing, accepting, laying or otherwise entering into any Bet with any other party (whether individual, company or otherwise) in relation to the result, progress, conduct or any other aspect of any International Match.
- 2.2.2 Directly or indirectly soliciting, inducing, enticing, instructing, persuading, encouraging, intentionally facilitating or authorising any other party to enter into a Bet in relation to the result, progress, conduct or any other aspect of any International Match.

2.3 Misuse of Inside Information:

- 2.3.1 Using any Inside Information for Betting purposes in relation to any International Match.
- 2.3.2 Disclosing Inside Information to any person where the Participant knew or should have known that such disclosure might lead to the information being used in relation to Betting in relation to any International Match.

NOTE: Any potential offence under this Article will be considered on its own set of facts and the particular circumstances surrounding any relevant disclosure. For example, it may be an offence under this clause to disclose Inside Information: (a) to journalists or other members of the media; and/or (b) on social networking websites where the Participant knew or should have known that such disclosure might lead to the information being used in relation to Betting. However, nothing in this Article is intended to prohibit any such disclosure made within a personal relationship (such as to a member of a family) where it is reasonable for the Participant to expect that such information can be disclosed in confidence and will not be subsequently used for Betting.

- 2.3.3 Directly or indirectly soliciting, inducing, enticing, persuading, encouraging or intentionally facilitating any Participant to breach any of the foregoing provisions of this Article 2.3.

2.4 General:

- 2.4.1 Giving or providing to any Participant any gift, payment, hospitality or other benefit (whether of a monetary value or otherwise) either (a) for the purpose of procuring (directly or indirectly) any breach of the Anti-Corruption Code, or (b) in circumstances that could bring him/her or the sport of cricket into disrepute.
- 2.4.2 Failing to disclose to the ACU (without unnecessary delay) the receipt of any gift, payment, hospitality or other benefit, (a) that the Participant knew or should have known was given to him/her to procure (directly or indirectly) any breach of the Anti-Corruption Code, or (b) that was made or given in circumstances that could bring the Participant or the sport of cricket into disrepute.
- 2.4.3 Failing to disclose to the ACU (without unnecessary delay) all gifts (whether monetary or otherwise), hospitality and/or other non-contractual benefits offered to a Participant that have a value of US\$750 or more, whether or not the circumstances set out in Article 2.4.2 are present, save that there shall be no obligation to disclose any (i) personal gifts, hospitality and/or other non-contractual benefits offered by or on behalf of any close friend or relative of the Participant, (ii) any food or beverage gifts or (iii) cricket hospitality gifts in connection with Matches the Participant is participating in.
- 2.4.4 Failing to disclose to the ACU (without unnecessary delay) full details of any approaches or invitations received by the Participant to engage in Corrupt Conduct under the Anti-Corruption Code.

NOTE: For the purposes of any disclosures made pursuant to either Article 2.4.2 or 2.4.3 such disclosures must be made to the ACU, which shall keep a register of all such disclosures, and will share the content of such register (or any part of it) with the relevant National Cricket Federation(s) on a quarterly basis, or unless otherwise agreed.

NOTE: It is acknowledged that the fight against corruption requires prompt reporting of all such approaches and any unnecessary delay in doing so may undermine the effectiveness with which the ACU and other relevant anti-corruption bodies can protect the integrity of the sport. It is acknowledged that the assessment of whether there had been 'unnecessary delay' in each case will depend on its own circumstances, but it is always unacceptable (and will therefore constitute 'unnecessary delay') for a Participant to wait until after the match in respect of which he/she was invited to engage in Corrupt Conduct before reporting that approach to the ACU.

NOTE: A Participant shall not discharge his burden under this Article unless and until the required disclosure has been made directly to the ACU by such Participant. It is not sufficient for such disclosure to be made instead to any other third party, including any player, club or team official, or National Cricket Federation representative.

- 2.4.5 Failing to disclose to the ACU (without unnecessary delay) full details of any incident, fact, or matter that comes to the attention of a Participant that may evidence Corrupt Conduct under the Anti-Corruption Code by another Participant, including (without limitation) approaches or invitations that have been received by another Participant to engage in Corrupt Conduct under the Anti-Corruption Code.

NOTE: All Participants have a continuing obligation to report any new incident, fact, or matter that may evidence Corrupt Conduct to the ACU, even if the Participant's prior knowledge has already been reported. It is acknowledged that the fight against corruption requires prompt reporting of all such approaches and any unnecessary delay in doing so may undermine the effectiveness with which the ACU and other relevant anti-corruption bodies can protect the integrity of the sport. It is acknowledged that the assessment of whether there had been 'unnecessary delay' in each case will depend on its own circumstances, but it is always unacceptable (and will therefore constitute 'unnecessary delay') for a Participant to wait until after the match in respect of which he/she was invited to engage in Corrupt Conduct before reporting that approach to the ACU.

- 2.4.6 Failing or refusing, without compelling justification to cooperate with any investigation carried out by the ACU in relation to possible Corrupt Conduct under the Anti-Corruption Code (by any Participant), including (without limitation) failing to provide accurately and completely any information and/or documentation requested by the ACU (whether as part of a formal Demand pursuant to Article 4.3 or otherwise) as part of such investigation.
- 2.4.7 Obstructing or delaying any investigation that may be carried out by the ACU in relation to possible Corrupt Conduct under the Anti-Corruption Code (by any Participant), including (without limitation) concealing, tampering with or destroying any documentation or other information that may be relevant to that investigation and/or that may be evidence of or may lead to the discovery of evidence of Corrupt Conduct under the Anti-Corruption Code.
- 2.4.8 Failing or refusing, to cooperate with any proceedings brought against any Participant for Corrupt Conduct under the Anti-Corruption Code, including (without limitation) failing to provide a witness statement(s) in respect of information in the possession of the Participant and/or failing to attend, for the purposes of providing truthful oral evidence, any disciplinary hearing convened before an Anti-Corruption Tribunal and/or CAS under the Anti-Corruption Code, where requested by the ACU.
- 2.4.9 Directly or indirectly soliciting, inducing, enticing, persuading, encouraging or intentionally facilitating any Participant to breach any of the foregoing provisions of this Article 2.4.

- 2.5 For the purposes of this Article 2:
- 2.5.1 Any attempt by a Participant, or any agreement by a Participant with any other person, to act in a manner that would culminate in the commission of an offence under the Anti-Corruption Code, shall be treated as if an offence had been committed, whether or not such attempt or agreement in fact resulted in such offence.
- 2.5.2 A Participant who authorises, causes, knowingly assists, encourages, aids, abets, covers up or is otherwise complicit in any acts or omissions of the type described in Articles 2.1 – 2.4 committed by his/her coach, trainer, manager, agent, family member, guest or other affiliate or associate shall be treated as having committed such acts or omissions him/herself and shall be liable accordingly under the Anti-Corruption Code.
- 2.5.3 Where a Participant seeks to rely on the existence of 'compelling justification' to justify or excuse conduct under the Anti-Corruption Code which might otherwise amount to an offence (see Article 2.4.6), the burden shall be on that Participant to adduce sufficient credible evidence to prove, on the balance of probabilities, that genuine and powerful reasons exist (or existed) to objectively justify his/her conduct taking into account all the relevant circumstances.
- 2.6 The following are not relevant to the determination of an offence under the Anti-Corruption Code (although they may be relevant to the issue of the sanction to be imposed under Article 6 in the event that it is determined that an offence has been committed):
- 2.6.1 Whether or not the Participant was participating or involved in any way in the specific International Match(es) in question.
- 2.6.2 The nature or outcome of any Bet(s) on the International Match(es) in question.
- 2.6.3 The outcome of the International Match(es) in question.
- 2.6.4 Whether or not the Participant's efforts or performance (if any) in the International Match(es) in question were (or could be expected to be) affected by the acts or omissions in question.
- 2.6.5 Whether or not any of the results in the International Match(es) in question were (or could be expected to be) affected by the act or omissions in question.
- 2.7 It shall be a valid defence to a charge of:
- 2.7.1 any offence under the Anti-Corruption Code to prove, on the balance of probabilities, that the alleged offence was committed (and that, where applicable, it was not reported to the ACU thereafter) due to the Participant's honest and reasonable belief that there was a serious threat to his/her life or safety or to the life or safety of any other person; and
- 2.7.2 an offence under Article 2.4.8 of the Anti-Corruption Code if the Participant adduces sufficient credible evidence to prove, on the balance of probabilities, that genuine and powerful reasons exist (or existed) to objectively justify his/her conduct taking into account all the relevant circumstances (and for which purpose the right to invoke the privilege against self-incrimination is deemed to have been waived by each Participant and shall not be a sufficient reason).

ARTICLE 3 – STANDARD OF PROOF AND EVIDENCE

- 3.1 Unless otherwise stated elsewhere in this Anti-Corruption Code, the burden of proof shall be on the ICC in all cases brought under the Anti-Corruption Code and the standard of proof shall be whether the Anti-Corruption Tribunal is comfortably satisfied that the alleged offence has been committed, bearing in mind the seriousness of the allegation that is being made. This standard of proof in all cases is greater than a mere balance of probability but less than proof beyond a reasonable doubt.
- 3.2 The following rules of proof shall be applicable at the hearing:
- 3.2.1 The Anti-Corruption Tribunal shall not be bound by rules governing the admissibility of evidence in judicial or other proceedings. Instead, facts may be established by any reliable means, including admissions and circumstantial evidence.
- 3.2.2 The Anti-Corruption Tribunal shall have discretion to accept any facts established by a decision of a court or professional disciplinary tribunal of competent jurisdiction that is not the subject of a pending appeal as irrebuttable evidence of those facts as against the Participant to whom the decision pertained, unless the Participant establishes that the decision violated principles of natural justice.
- 3.2.3 The Anti-Corruption Tribunal may draw an inference adverse to a Participant who is asserted to have committed an offence under the Anti-Corruption Code based on his/her refusal, without compelling justification, after a request made in a reasonable time in advance of the hearing, to appear at the hearing (either in person or by video or telephone link, as directed by the Anti-Corruption Tribunal) and to answer any relevant questions.

ARTICLE 4 – INVESTIGATIONS AND NOTICE OF CHARGE

- 4.1 Any allegation or suspicion of a breach of the Anti-Corruption Code, whatever the source, shall be referred to the ACU General Manager for investigation.
- 4.2 The ACU may at any time conduct an investigation into the activities of any Participant that it believes may have committed an offence under the Anti-Corruption Code. Such investigations may be conducted in conjunction with, and/or information obtained in such investigations may be shared with, National Cricket Federations and/or other relevant authorities (including criminal, administrative, professional and/or judicial authorities). All Participants and National Cricket Federations must cooperate fully with such investigations, failing which any such Participant shall be liable to be charged with a breach of the Anti-Corruption Code pursuant to Articles 2.4.6, 2.4.7, 2.4.8 and/or 2.4.9 (and it shall not be a valid basis for failing or refusing to cooperate or a valid defence to any such subsequent charge for a Participant to invoke any privilege against self-incrimination, which privilege is deemed to have been waived by the Participant). The ACU shall have discretion, where it deems appropriate, to stay its own investigation pending the outcome of investigations being conducted by other National Cricket Federations and/or other relevant authorities.

- 4.3 As part of any investigation, the ACU General Manager may at any time (including after a Notice of Charge has been provided to a relevant Participant) make a written demand to any Participant (a “Demand”) to provide the ACU, in writing and/or by answering questions in person at an interview and/or by allowing the ACU to take possession of and/or copy or download information from his/her Mobile Device(s) (as the ACU General Manager elects), with any information that the ACU General Manager reasonably believes may be relevant to the investigation. Such information may include (without limitation) (a) copies or access to all relevant records (such as current or historic telephone records, bank statements, Internet services records and/or other records stored on computer hard drives or other information storage equipment or any consent forms related thereto); (b) any data and/or messages and/or photographs and/or videos and/or audio files and/or documents or any other relevant material contained on his/her Mobile Device(s) (including, but not limited to, information stored through SMS, WhatsApp or any other messaging system); and/or (c) all of the facts and circumstances of which the Participant is aware with respect to the matter being investigated. Provided that any such Demand has been issued in accordance with this Article, and subject to any applicable principles of national law, the Participant shall cooperate fully with such Demand, including by furnishing such information within such reasonable period of time as may be determined by the ACU General Manager. Where such a Demand relates to the request to take possession of and/or copy or download information contained on a Participant’s Mobile Device, then such information shall be provided immediately upon the Participant’s receipt of the Demand. In all other cases, save where exceptional circumstances exist, a minimum period of fourteen days from receipt of the Demand will be provided. Where appropriate, the Participant may seek an extension of such deadline by providing the ACU General Manager with cogent reasons to support an extension, provided that the decision to grant or deny such extension shall be in the discretion of the ACU General Manager, acting reasonably at all times.
- 4.4 Any information furnished to the ACU General Manager (whether pursuant to a specific Demand or otherwise as part of an investigation) will not be used for any purpose other than in accordance with the Anti-Corruption Code and will be kept strictly confidential except when:
- 4.4.1 it becomes necessary to disclose such information in support of a charge of breach of the Anti-Corruption Code or the anti-corruption rules of any National Cricket Federation;
- 4.4.2 such information is required to be disclosed by any applicable law;
- 4.4.3 such information is already published or a matter of public record, readily acquired by an interested member of the public, or disclosed according to the rules and regulations governing the relevant International Match; and/or
- 4.4.4 it becomes necessary (because the information gathered may also amount to or evidence infringements of other applicable laws or regulations) to disclose such information to other competent authorities (including any applicable police, taxation, fraud, criminal intelligence or other authorities), whether pursuant to formal information-sharing agreements or otherwise.

- 4.5 All Participants must cooperate with the ACU in relation to any proceedings brought against any other Participant for Corrupt Conduct in breach of the Anti-Corruption Code, including (without limitation) through the provision of a witness statement(s) in respect of information in the possession of the Participant and/or attending, for the purposes of providing truthful oral evidence, any disciplinary hearing convened before an Anti-Corruption Tribunal and/or CAS under the Anti-Corruption Code, where requested by the ACU, failing which the non-cooperating Participant shall be liable to be charged with a breach of the Anti-Corruption Code pursuant to Article 2.4.8. In light of the waiver contained in Article 2.7.2, it shall not be a valid basis for failing or refusing to cooperate or a valid defence to any such subsequent charge for a Participant to invoke any privilege against self-incrimination.
- 4.6 If, at any time, the ICC's General Counsel (in the case of all Participants other than Directors), or the Chairman of the ICC's Independent Oversight Group (in the case of Directors only), in both cases having consulted in accordance with relevant ICC policy, determines that there is a case to answer under Article 2, then the Participant shall be sent written notice of the following, copied to the anti-corruption official or senior legal officer of the National Cricket Federation to which he/she is affiliated (or, where there are no individuals holding such positions, the CEO of the National Cricket Federation) (the "Notice of Charge"):
- 4.6.1 that the Participant has a case to answer under Article 2;
- 4.6.2 the specific offence(s) that the Participant is alleged to have committed;
- 4.6.3 details of the alleged acts and/or omissions relied upon in support of the charge;
- 4.6.4 the range of sanctions applicable under the Anti-Corruption Code if the charge is admitted or upheld;
- 4.6.5 (where applicable) the matters relating to Provisional Suspension specified at Article 4.7; and
- 4.6.6 that if the Participant wishes to exercise his/her right to a hearing before the Anti-Corruption Tribunal (whether to contest liability or sanction or both), he/she must submit a written request for a hearing that explains how the Participant responds to the charge(s) and (in summary form) the basis for such response. To be effective, the request must be received by the ICC's General Counsel as soon as possible, but in any event within fourteen (14) days of the Participant's receipt of the Notice of Charge. A copy of any such notice will be sent by the ICC to the National Cricket Federation to which the Participant is affiliated without unnecessary delay.
- 4.7 **Provisional Suspension:**
- 4.7.1 Where either: (a) the ICC's General Counsel (in the case of all Participants other than Directors) or the Chairman of the ICC's Independent Oversight Group (in the case of Directors only), in both cases having consulted in accordance with relevant ICC policy, decides to charge a Participant with an offence under the Anti-Corruption Code; or (b) the ICC's General Counsel (in the case of all Participants other than Directors) or Chairman of the

ICC's Independent Oversight Group (in the case of Directors only), in both cases having consulted in accordance with relevant ICC policy, considers that there are other exceptional circumstances relevant to a Participant (for example, where any relevant police authority has arrested and/or charged a Participant with an offence under any relevant criminal law in respect of facts or circumstances that may also constitute an offence under the Anti-Corruption Code), he/she shall have the discretion, in circumstances where he/she considers that the integrity of the sport could otherwise be seriously undermined, to Provisionally Suspend the Participant pending the Anti-Corruption Tribunal's determination of whether he/she has committed an offence. Any decision to Provisionally Suspend the Participant will be communicated to the Participant in writing, with a copy sent at the same time to the National Cricket Federation to which the Participant is affiliated.

- 4.7.2 In all cases, the Participant shall be given an opportunity to contest such Provisional Suspension in a Provisional Hearing taking place before the Chairman of the ICC Code of Conduct Commission (sitting alone) on a timely basis after its imposition. At any such Provisional Hearing, it shall be the burden of the ICC to establish that in such circumstances, the integrity of the sport could be seriously undermined if he/she does not remain Provisionally Suspended pending determination of the charge(s) or such other date (as may be applicable). The Provisional Hearing shall take place on the basis of written submissions alone, save where the Chairman of the ICC Code of Conduct Commission, in his absolute discretion, determines that a hearing should be convened. Any Provisional Hearing shall ensure that the Participant is afforded a fair and reasonable opportunity to present evidence, address the Chairman, and present his/her case. Notice of any decision made at a Provisional Hearing will be sent by the ICC to the National Cricket Federation to which the Participant is affiliated as soon as such decision has been made.
- 4.7.3 Where a full hearing under Article 5 has not been convened within three (3) months of the imposition of a Provisional Suspension, the Participant shall be entitled to apply (again, where applicable) to the Chairman of the ICC Code of Conduct Commission (sitting alone) to lift the imposition of the Provisional Suspension. It shall be the burden of the ICC to establish that there remains a risk that the integrity of the sport could be seriously undermined if the Provisional Suspension was lifted. The application shall be determined on the basis of written submissions alone, save where the Chairman of the ICC Code of Conduct Commission, in his absolute discretion, determines that a hearing should be convened. Any consideration of such an application by the Chairman of the ICC Code of Conduct Commission shall ensure that the Participant is afforded a fair and reasonable opportunity to present evidence, address the Chairman, and present his/her case. Notice of any decision made by the Chairman of the ICC Code of Conduct Commission will be sent by the ICC to the National Cricket Federation to which the Participant is affiliated as soon as such decision has been made.

- 4.7.4 While Provisionally Suspended, a Participant may not play, coach or otherwise participate or be involved in any capacity in any Match or any other kind of function, event or activity (other than authorised anti-corruption education or rehabilitation programs) that is authorised, organised, sanctioned, recognised or supported in any way by the ICC, a National Cricket Federation, or any member under the jurisdiction of a National Cricket Federation, or receive accreditation to provide media or other services at any official venue or Match. National Cricket Federations shall take all reasonable steps within their powers to give effect to this Article 4.7.4 to the extent that they have the jurisdiction, power or ability to do so.
- 4.7.5 A Participant who is not Provisionally Suspended may voluntarily Provisionally Suspend him/herself by written notice to the ICC's General Counsel. In that case, provided that the Participant respects that voluntary Provisional Suspension until the charge(s) against him/her is/are determined, he/she shall be given credit for such voluntary Provisional Suspension in accordance with Article 6.4. A copy of any such notice will be sent by the ICC to the National Cricket Federation to which the Participant is affiliated without unnecessary delay.

4.8 Responding to a Notice of Charge:

- 4.8.1 If the Participant fails to file a written request for a hearing before the Anti-Corruption Tribunal in accordance with Article 4.6.6 (or by any extended deadline that the ICC's General Counsel deems appropriate), then he/she shall be deemed to have:
- 4.8.1.1 waived his/her entitlement to a hearing;
- 4.8.1.2 admitted that he/she has committed the offence(s) under the Anti-Corruption Code specified in the Notice of Charge; and
- 4.8.1.3 acceded to the range of applicable sanctions specified in the Notice of Charge.
- In such circumstances, a hearing before the Anti-Corruption Tribunal shall not be required. Instead, the ICC's Chief Executive Officer (in consultation with ICC's General Counsel) shall promptly issue a public decision confirming the offence(s) under the Anti-Corruption Code specified in the Notice of Charge and the imposition of an applicable sanction within the range specified in the Notice of Charge. Before issuing that public decision, the ICC's Chief Executive Officer will provide written notice of that decision to the National Cricket Federation to which the Participant is affiliated.
- 4.8.2 Where the Participant does request a hearing in accordance with Article 4.6.6, the matter shall proceed to a hearing in accordance with Article 5.

ARTICLE 5 – THE DISCIPLINARY PROCEDURE

5.1 Hearings under the Anti-Corruption Code

- 5.1.1 Where the ICC alleges that a Participant has committed an offence under the Anti-Corruption Code, and the Participant submits the response required under Article 4.6.6 by the specified deadline, disputing the charge and/or the sanctions to be imposed for such offence under the Anti-Corruption Code, the matter shall be referred to the Chairman of the ICC Code of Conduct Commission.
- 5.1.2 The Chairman of the ICC Code of Conduct Commission shall appoint three members from the ICC Code of Conduct Commission (which may include the Chairman) to form an Anti-Corruption Tribunal to hear the case. One member of the Anti-Corruption Tribunal, who shall be a lawyer, shall sit as the Chairman of the Anti-Corruption Tribunal. The appointed members shall be independent of the parties, shall have had no prior involvement with the case, and shall not (unless otherwise agreed between the parties) be from the same country as the Participant who is the subject of the proceedings.
- 5.1.3 The Chairman of the Anti-Corruption Tribunal shall convene a preliminary hearing with the ICC and its legal representatives, together with the Participant and his/her legal representatives (if any). At the reasonable discretion of the Chairman, a representative of the National Cricket Federation to which the Participant is affiliated may also attend such hearing (but strictly as an observer only and with no right to be heard). The preliminary hearing should take place as soon as possible by telephone conference call unless the Chairman determines otherwise. The non-participation of the Participant or his/her representative at the preliminary hearing, after proper notice of the preliminary hearing has been provided, shall not prevent the Chairman of the Anti-Corruption Tribunal from proceeding with the preliminary hearing, whether or not any written submissions are made on behalf of the Participant. Notice of any orders or directions made at the preliminary hearing will be sent by the ICC to the National Cricket Federation to which the Participant is affiliated without unnecessary delay following the conclusion of the preliminary hearing.
- 5.1.4 The purpose of the preliminary hearing shall be to allow the Chairman to address any issues that need to be resolved prior to the hearing date. In particular (but without limitation), the Chairman shall:
- 5.1.4.1 determine the date(s) upon which the full hearing shall be held. Save where the Chairman in his discretion orders otherwise, the full hearing should ordinarily take place no more than forty (40) days after the date of the preliminary hearing;

- 5.1.4.2 establish dates reasonably in advance of the date of the full hearing by which:
- a) the ICC shall submit an opening brief with argument on all issues that the ICC wishes to raise at the hearing and a written statement from each witness that the ICC intends to call at the hearing, setting out his/her direct evidence, and enclosing copies of the documents that the ICC intends to rely on at the hearing;
 - b) the Participant shall submit an answering brief, addressing the ICC's arguments and setting out argument on the issues that he/she wishes to raise at the hearing, as well as a written statement from each witness that he/she intends to call at the hearing, setting out that witness's direct evidence, and enclosing copies of the documents that he/she intends to rely on at the hearing; and
 - c) the ICC may (at its discretion) submit a reply brief, responding to the answer brief of the Participant and providing a witness statement from each rebuttal witness that the ICC intends to call at the hearing, setting out his/her direct evidence, and enclosing copies of any further documents that the ICC intends to rely on at the hearing; and
- 5.1.4.3 order such consolidation with other case(s) as the Chairman shall deem appropriate. For example, where two or more Participants are alleged to have committed offences under the Anti-Corruption Code, they may both be dealt with at the same hearing where the proceedings arise out of the same incident or set of facts, or where there is a clear link between separate incidents; and
- 5.1.4.4 make such order as the Chairman shall deem appropriate (subject to any principles of applicable national law) in relation to the production of relevant documents and/or other materials between the parties.
- 5.1.5 The Participant shall be required to raise at the preliminary hearing any legitimate objection that he/she may have to any of the members of the Anti-Corruption Tribunal convened to hear his/her case. Any unjustified delay in raising any such objection shall constitute a waiver of the objection. If any objection is made, the Chairman of the Anti-Corruption Tribunal shall rule on its legitimacy (or, if the objection relates to the Chairman of the Tribunal, the Chairman of the ICC Code of Conduct Commission shall rule on its legitimacy).
- 5.1.6 If, because of a legitimate objection or for any other reason, a member of the Anti-Corruption Tribunal is, or becomes, unwilling or unable to hear the case, then the Chairman of the ICC Code of Conduct Commission may, at his/her absolute discretion: (a) appoint a replacement member of the Anti-Corruption Tribunal from the ICC's Code of Conduct Commission; or (b) authorise the remaining members to hear the case on their own.
- 5.1.7 Subject to the discretion of the Chairman of the Anti-Corruption Tribunal to order otherwise for good cause shown by either party (for example, and notwithstanding clause 5.1.8, where, having due regard to the seriousness of the alleged offence, the costs of attending any hearing are disproportionate to the Participant's means and therefore prohibit him/her from having a fair opportunity to present his/her case), or unless otherwise agreed between the parties, hearings before the Anti-Corruption Tribunal shall (a) take place at the ICC's headquarters in Dubai, United Arab Emirates; and (b) be conducted on a confidential basis.
- 5.1.8 Each of the ICC and the Participant has the right to be present and to be heard at the hearing and (at his/her or its own expense) to be represented at the hearing by legal counsel of his/her or its own choosing. At the reasonable discretion of the Anti-Corruption Tribunal, a representative of the National Cricket Federation to which the Participant is affiliated may also attend any such hearing (but strictly as an observer only and with no right to be heard). Where there is compelling justification for the non-attendance by any party or representative at the hearing, then such party or representative shall be given the opportunity to participate in the hearing by telephone or video conference (if available).
- 5.1.9 Without prejudice to Article 3.2.2, the Participant may choose not to appear in person at the hearing, but instead may provide a written submission for consideration by the Anti-Corruption Tribunal, in which case the Anti-Corruption Tribunal shall consider the submission in its deliberations. However, the non-attendance of the Participant or his/her representative at the hearing, without compelling justification, after proper notice of the hearing has been provided, shall not prevent the Anti-Corruption Tribunal from proceeding with the hearing in his/her absence, whether or not any written submissions are made on his/her behalf. A copy of any such written submission will be sent by the ICC to the National Cricket Federation to which the Participant is affiliated without unnecessary delay after it is received.
- 5.1.10 The procedure to be followed at the hearing (including whether to convene a hearing or, alternatively, to determine the matter (or any part thereof) by way of written submissions alone) shall be at the discretion of the Chairman of the Anti-Corruption Tribunal, provided that the hearing is conducted in a manner that affords the Participant a fair and reasonable opportunity to present evidence (including the right to call and to question witnesses by telephone or video-conference where necessary), address the Anti-Corruption Tribunal, and present his/her case.

- 5.111 Save where the Chairman orders otherwise for good cause shown by either party, the hearing shall be in English, evidence shall be given in English (with the cost of any necessary translation borne by the party offering the evidence), and certified English translations shall be submitted of any non-English documents put before the Anti-Corruption Tribunal (with the cost of the translation borne by the party offering the documents). If required by the Chairman, the ICC shall make arrangements to have the hearing recorded or transcribed (save for the private deliberations of the Anti-Corruption Tribunal). The costs of such transcription shall be paid by the ICC, subject to any costs-shifting order that the Anti-Corruption Tribunal may make further to Article 5.2.4.
- 5.112 Notwithstanding any of the other provisions of this Anti-Corruption Code, at any time during the proceedings it shall be open to a Participant charged with breach(es) of the Anti-Corruption Code to admit the breach(es) charged, whether or not in exchange for an agreement with the ICC on the appropriate sanction to be imposed upon him/her in order to avoid the need for a hearing before the Anti-Corruption Tribunal. Any such discussions between the ICC and the Participant shall take place on a “without prejudice” basis and in such a manner that they shall not delay or in any other way interfere with the proceedings. Any resulting agreement shall be evidenced in writing, signed by both the ICC’s General Counsel and the Participant, and shall set out the sanction imposed on the Participant for his/her breach of the Anti-Corruption Code (the “**Agreed Sanction**”). In determining the Agreed Sanction the ICC will have due regard to the range of sanctions set out in Article 6.2 for the offence(s) in question, but it shall not be bound to impose a sanction within that range where it reasonably considers (at its absolute discretion) that there is good reason to depart therefrom. Upon receipt of notice of the Agreed Sanction, the Anti-Corruption Tribunal shall discontinue the proceedings on the terms thereof without the need for any further hearing. Instead the ICC’s Chief Executive Officer (in consultation with the ICC’s General Counsel) shall promptly issue a public decision confirming the Participant’s admission of the offence(s) charged and the imposition of the Agreed Sanction. Before issuing that public decision, the ICC’s Chief Executive Officer will provide notice of it to the National Cricket Federation to which the Participant is affiliated.

5.2 Decisions of the Anti-Corruption Tribunal

- 5.2.1 The Anti-Corruption Tribunal shall announce its decision in writing, with reasons, as soon as possible after, and, in any event, within thirty (30) days of, the conclusion of the hearing. That written decision will set out and explain:
- 5.2.11 with reasons, the Anti-Corruption Tribunal’s findings as to whether any offence(s) under the Anti-Corruption Code has/have been committed;
- 5.2.12 with reasons, the Anti-Corruption Tribunal’s findings as to what sanctions, if any, are to be imposed (including any fine and/or period of Ineligibility);

5.2.13 with reasons, the date that such period of Ineligibility shall commence pursuant to Article 6.4; and

5.2.14 the rights of appeal described in Article 7.

- 5.2.2 The ICC will provide the National Cricket Federation to which the Participant is affiliated with a full written copy of the findings and decisions of the Anti-Corruption Tribunal (including any sanctions imposed by the Anti-Corruption Tribunal) at the same time as such decision is provided to the Participant and prior to publicly announcing such decision.
- 5.2.3 The Anti-Corruption Tribunal shall have discretion to announce the substance of its decision to the parties prior to the issue of the written reasoned decision referred to in Article 5.2.1 in cases where a Provisional Suspension has been imposed or where it otherwise deems appropriate. For the avoidance of doubt, however: (a) the Anti-Corruption Tribunal shall still be required to issue a written, reasoned decision in accordance with Article 5.2.1; and (b) the time to appeal pursuant to Article 7 shall not run until receipt of that written, reasoned decision. Notice of such decision will be provided by the ICC to the National Cricket Federation to which the Participant is affiliated without unnecessary delay following its announcement.
- 5.2.4 The Anti-Corruption Tribunal has the power to make a costs order against any party to the hearing in respect of the costs of convening the Anti-Corruption Tribunal and of staging the hearing and/or in respect of the costs (legal, expert, travel, accommodation, translation or otherwise) incurred by the parties in relation to the proceedings where it deems fit (for example, but without limitation, where it considers that such party has acted spuriously, frivolously or otherwise in bad faith). If it does not exercise that power, the ICC shall pay the costs of convening the Anti-Corruption Tribunal and of staging the hearing, and each party shall bear its own costs (legal, expert, travel, accommodation, translation or otherwise).
- 5.2.5 Subject only to the rights of appeal under Article 7, the Anti-Corruption Tribunal’s decision shall be the full, final and complete disposition of the matter and will be binding on all parties.

ARTICLE 6 – SANCTIONS

- 6.1 Where a breach of the Anti-Corruption Code is admitted by the Participant or upheld by the Anti-Corruption Tribunal, the Anti-Corruption Tribunal will be required to impose an appropriate sanction upon the Participant from the range of permissible sanctions described in Article 6.2. In order to determine the appropriate sanction that is to be imposed in each case, the Anti-Corruption Tribunal must first determine the relative seriousness of the offence, including identifying all relevant factors that it deems to:
- 6.1.1 aggravate the nature of the offence, including (without limitation):
- 6.1.1.1 a lack of remorse on the part of the Participant;

- 6.1.1.2 the Participant’s bad previous disciplinary record (including where the Participant has previously been found guilty of another offence under the Anti-Corruption Code and/or any predecessor regulations of the ICC and/or any anti-corruption rules of any National Cricket Federation);
- 6.1.1.3 where the amount of any profits, winnings or other Reward directly or indirectly received by the Participant as a result of the offence(s) is substantial and/or where the sums of money otherwise involved in the offence(s) were substantial;
- 6.1.1.4 where the offence substantially damaged (or had the potential to damage substantially) the commercial value and/or the public interest in the relevant International Match(es);
- 6.1.1.5 where the offence affected (or had the potential to affect) the result of the relevant International Match(es);
- 6.1.1.6 where the welfare of a Participant or any other person has been endangered as a result of the offence;
- 6.1.1.7 where the offence involved more than one Participant; and/or
- 6.1.1.8 any other aggravating factor(s) that the Anti-Corruption Tribunal considers relevant and appropriate.
- 6.1.2 mitigate the nature of the offence, including (without limitation):
 - 6.1.2.1 any admission of guilt (the mitigating value of which may depend upon its timing);
 - 6.1.2.2 the Participant’s good previous disciplinary record;
 - 6.1.2.3 the youth and/or lack of experience of the Participant;
 - 6.1.2.4 where the Participant renounced the attempt or agreement prior to it being discovered by a third party not involved in the attempt or agreement.
 - 6.1.2.5 where the Participant has cooperated with the ACU and any investigation or Demand carried out by it;
 - 6.1.2.6 where the offence did not substantially damage (or have the potential to substantially damage) the commercial value, integrity of results and/or the public interest in the relevant International Match(es);
 - 6.1.2.7 where the offence did not affect (or have the potential to affect) the result of the relevant International Match(es);
 - 6.1.2.8 where the Participant provides Substantial Assistance to the ICC, any other National Cricket Federation, a criminal authority, or a professional disciplinary body;
 - 6.1.2.9 where the Participant has already suffered penalties under other laws and/or regulations for the same offence; and/or
 - 6.1.2.10 any other mitigating factor(s) that the Anti-Corruption Tribunal considers relevant and appropriate.

6.2 Having considered all of the factors described in Articles 6.1.1 and 6.1.2, the Anti-Corruption Tribunal shall then determine, in accordance with the following table, what the appropriate sanction(s) should be:

ANTI-CORRUPTION CODE OFFENCE	RANGE OF PERMISSIBLE PERIOD OF INELIGIBILITY	ADDITIONAL DISCRETION TO IMPOSE A FINE
Article 2.11, 2.1.2, 2.1.3 or 2.1.4 (Corruption)	A minimum of five (5) years and a maximum of a lifetime.	In all cases, in addition to any period of Ineligibility, the Anti-Corruption Tribunal shall have the discretion to impose a fine on the Participant of such amount as it deems appropriate.
Article 2.2.1 or 2.2.2 (Betting)	A minimum of one (1) year and a maximum of five (5) years.	
Article 2.3.1 or 2.3.3 (as it relates to an offence under Article 2.3.1) (Misuse of Inside Information)	A minimum of one (1) year and a maximum of five (5) years.	
Article 2.3.2 or 2.3.3 (as it relates to an offence under Article 2.3.2) (Misuse of Inside Information)	A minimum of six (6) months and a maximum of five (5) years.	
Any of Articles 2.4.1 to 2.4.6, inclusive (General)	A minimum of six (6) months and a maximum of five (5) years.	
Any of Articles 2.4.7 to 2.4.9 inclusive (General)	Any period from zero up to a maximum of five (5) years.	

6.3 For the avoidance of doubt:

- 6.3.1 the Anti-Corruption Tribunal has no jurisdiction to adjust, reverse or amend the results of any Match;
 - 6.3.2 where a Participant is found guilty of committing two offences under the Anti-Corruption Code in relation to the same incident or set of facts, then (save where ordered otherwise by the Anti-Corruption Tribunal for good cause shown) any multiple periods of Ineligibility imposed should run concurrently (and not cumulatively);
 - 6.3.3 where a fine and/or costs award is imposed against a Participant, such fine and/or costs award must be paid: (a) by the Participant (and not, unless the ICC agrees, by any other third party, including a National Cricket Federation); (b) directly to the ICC no later (subject to Article 6.7) than one calendar month following receipt of the decision imposing the fine; and
 - 6.3.4 the ICC will provide the National Cricket Federation of the Participant with written notice of (and a full written copy of) the findings and decisions of the Anti-Corruption Tribunal (including any sanctions imposed by the Anti-Corruption Tribunal) at the same time as such decision is provided to the Participant and prior to publicly announcing such decision.
- 6.4 Any period of Ineligibility imposed on a Participant shall commence on the date that the decision imposing the period of Ineligibility is issued; provided that any period of Provisional Suspension served by the Participant shall be credited against the total period of Ineligibility to be served.

- 6.5** No Participant who has been declared Ineligible may, during the period of Ineligibility, play, coach, officiate or otherwise participate or be involved in any capacity in any Match or any other kind of function, event or activity (other than authorised anti-corruption education or rehabilitation programs) that is authorised, organised, sanctioned, recognised or supported in any way by the ICC, a National Cricket Federation, or any member under the jurisdiction of a National Cricket Federation, or receive accreditation to provide media or other services at any official venue or Match. National Cricket Federations shall take all reasonable steps within their powers to give effect to this Article 6.5 to the extent that they have the jurisdiction, power or ability to do so.
- 6.6** A Participant who is subject to a period of Ineligibility shall remain subject to this Anti-Corruption Code and the anti-corruption rules of all National Cricket Federations during that period. If a Participant commits Corrupt Conduct during a period of Ineligibility, this shall be treated as a separate offence and new proceedings will be brought pursuant to Article 4.6 of this Anti-Corruption Code or under the anti-corruption rules of the relevant National Cricket Federation, as applicable.
- 6.7** Once any period of Ineligibility has expired, the Participant will automatically become re-eligible to participate or be otherwise involved in Matches provided that he/she has first: (a) completed an official anti-corruption education session to the reasonable satisfaction of the ACU; (b) agreed to subject him/herself to such additional reasonable and proportionate monitoring procedures and requirements as the ACU General Manager may reasonably consider necessary given the nature and scope of the offence committed; and (c) satisfied in full any fine and/or award of costs made against him/her by any Anti-Corruption Tribunal or the CAS. However, the ICC will consider any request from any Participant, on the grounds of financial hardship, to make the payment of such fines and/or costs over a prolonged period of time. Should any fine and/or costs award (or agreed part-payment or instalment thereof) not be paid to the ICC within such deadline or by the time of the next agreed payment date, then, unless the ICC agrees otherwise, the Participant may not play, coach or otherwise participate or be involved in any capacity in any Match until such payment has been satisfied in full.
- 6.8** The Chairman of the ACU shall, only after obtaining the prior written agreement of any relevant National Cricket Federation(s) and the prior approval of the ICC Board, have discretion to permit a Participant who is subject to a period of Ineligibility to participate or otherwise be involved in Domestic Matches at any time prior to the end of that period of Ineligibility where in the opinion of the Chairman of the ACU the early reinstatement of such eligibility is warranted by the conduct of the Participant since the period of Ineligibility was imposed, taking into account such factors as the ACU Chairman in his absolute discretion considers appropriate and given the underlying objectives of this Anti-Corruption Code. Such factors may include (without limitation) the fact and timing of any expressions of apology, remorse and/or contrition by the Participant, the Participant's cooperation with ACU education programmes, and/or the Participant's full disclosure of any and all information known to the Participant that may be helpful to the ACU in enforcing the Anti-Corruption Code or in otherwise furthering its objectives. For the avoidance of doubt, the Chairman of the ACU shall not in any circumstances have discretion to reinstate the Participant's eligibility to participate or otherwise be involved in International Matches prior to the end of the period of Ineligibility.

ARTICLE 7 – APPEALS

- 7.1** The following decisions made under the Anti-Corruption Code may be challenged by the ICC or the Participant who is the subject of the decision (as applicable) solely and exclusively by appeal to CAS as set out in this Article 7:
- 7.1.1** a decision by the Chairman of the ICC Code of Conduct Commission not to lift a Provisional Suspension;
- 7.1.2** a decision that a charge of breach of the Anti-Corruption Code should be dismissed for procedural or jurisdictional reasons;
- 7.1.3** a decision that an offence under the Anti-Corruption Code has (or has not) been committed; and/or
- 7.1.4** a decision to impose (or not to impose) sanctions, including the appropriateness of any sanction imposed for an offence under the Anti-Corruption Code.
- 7.2** For the avoidance of any doubt, no party shall have any right of appeal against (a) an Agreed Sanction imposed pursuant to Article 5.1.12; or (b) decisions by the Chairman of the ACU made pursuant to Article 6.8.
- 7.3** Decisions being appealed shall remain in effect and binding pending resolution of the appeal.
- 7.4** The deadline for filing an appeal to CAS shall be twenty-one (21) days from the date of receipt of the written reasoned decision by the appealing party. To be a valid filing under this Article, a copy of an appeal filed by the Participant must also be served on the same day on the ICC (which will thereafter provide a copy to the National Cricket Federation to which the Participant is affiliated).
- 7.5** In all appeals to CAS pursuant to this Article 7:
- 7.5.1** CAS's Code of Sports-related Arbitration shall apply, save as amended below.
- 7.5.2** Where required in order to do justice (for example to cure procedural errors at the first instance hearing), the appeal shall take the form of a re-hearing de novo of the issues raised by the case. In all other cases, the appeal shall not take the form of a de novo hearing but instead shall be limited to a consideration of whether the decision being appealed was erroneous.
- 7.5.3** The governing law shall be English law and the appeal shall be conducted in English, unless the parties agree otherwise.
- 7.5.4** The decision of CAS on the appeal shall be final and binding on all parties, and no right of appeal shall lie from the CAS decision.

ARTICLE 8 – PUBLIC DISCLOSURE AND CONFIDENTIALITY

- 8.1 Save in exceptional circumstances where the ICC (acting reasonably) deems it necessary for the purposes of protecting the integrity of the sport and/or any of its Participants (for example in circumstances where there is significant damaging and/or incorrect media speculation), neither the ICC nor any National Cricket Federation shall publicly identify any Participant who is being investigated or is alleged to have committed an offence under the Anti-Corruption Code until he/she has been formally charged pursuant to Article 4.6, at which point it shall be entitled to publicly announce the name of the Participant charged and the offences with which he/she has been charged. Thereafter, the ICC will not comment publicly on the specific facts of a pending case except in response to public comments made by (or on behalf of) the Participant involved in the case or his/her representatives or where otherwise necessary to preserve the public's confidence in the ability of the ICC and/or the National Cricket Federations to fight corruption in the sport.
- 8.2 Once the Anti-Corruption Tribunal has issued its decision in respect of any charges brought under the Anti-Corruption Code:
- 8.2.1 If the decision is that an offence has been committed: (a) the decision may, at the ICC's discretion, be publicly reported in full as soon as possible; and (b) after the decision is publicly reported, the ICC may also publish such other parts of the proceedings before the Anti-Corruption Tribunal as the ICC thinks fit.
- 8.2.2 If the decision exonerates the Participant, then the decision may be publicly reported only with the consent of the Participant. The ICC shall use reasonable efforts to obtain such consent, and (if consent is obtained) shall publicly disclose the decision in its entirety or in such redacted form as the Participant may approve.
- 8.3 The ICC shall use its best endeavours to ensure that persons under its control do not publicly identify Participants who are alleged to have committed an offence under the Anti-Corruption Code other than in accordance with Article 8.1 and 8.2. However, the ICC in its discretion may at any time disclose to other organisations such information as the ICC may consider necessary or appropriate to facilitate administration or enforcement of the Anti-Corruption Code, provided that each organisation provides assurance satisfactory to the ICC that the organisation will maintain all such information in confidence.

ARTICLE 9 – RECOGNITION OF DECISIONS

- 9.1 All National Cricket Federations shall comply with the Anti-Corruption Code and take all necessary and reasonable steps within their powers to recognise, enforce, extend and give effect to all decisions taken and Provisional Suspensions and sanctions imposed under the Anti-Corruption Code within their own respective jurisdictions, without the need for further formality. This shall include (without limitation), where it has the jurisdiction to do so, requiring the organisers of any Matches, tournaments or other events sanctioned by the National Cricket Federation to recognise and give effect to such decisions and Provisional Suspensions and sanctions.

- 9.2 Decisions made and Provisional Suspensions and sanctions imposed under the anti-corruption rules of National Cricket Federations shall be recognised, enforced, extended and given effect to within their respective jurisdictions by the ICC and other National Cricket Federations (including in respect of any Matches, tournaments or other events sanctioned by such National Cricket Federations), automatically upon receipt of notice of the same, without the need for further formality.

ARTICLE 10 – STATUTE OF LIMITATIONS

- 10.1 No action may be commenced under the Anti-Corruption Code against a Participant for an offence under the Anti-Corruption Code more than ten years after the date that the offence occurred.
- 10.2 Subject strictly to Article 10.1, the ICC has the right (but no obligation) to suspend investigations temporarily under this Anti-Corruption Code to avoid prejudice to, and/or to give precedence to, investigations conducted by other relevant authorities into the same or related matters.

ARTICLE 11 – AMENDMENT AND INTERPRETATION OF THE ANTI-CORRUPTION CODE

- 11.1 The Anti-Corruption Code may be amended from time to time by the ICC's Board, with such amendments coming into effect on the date specified by the ICC.
- 11.2 The headings used for the various Articles of the Anti-Corruption Code are for the purpose of guidance only and shall not be deemed to be part of the substance of the Anti-Corruption Code or to inform or affect in any way the language of the provisions to which they refer.
- 11.3 The Anti-Corruption Code shall come into full force and effect on 9 February 2018 (the "Effective Date"). It shall not operate to disturb any decisions and/or sanctions previously made under predecessor versions of the Anti-Corruption Code (including the Code of Conduct) or anti-corruption rules of National Cricket Federations. Nor shall its substantive provisions apply retrospectively to matters pending before the Effective Date. Instead, any case pending prior to the Effective Date, or brought after the Effective Date but based on acts or omissions that occurred before the Effective Date, shall be governed (a) as to substance, by the predecessor to the Anti-Corruption Code that was in force at the time of the alleged offence, subject to any application of the principle of *lex mitior* by the hearing panel determining the case; and (b) as to procedure, by this Anti-Corruption Code.
- 11.4 If any Article or provision of this Anti-Corruption Code is ruled to be invalid, unenforceable or illegal for any reason, it shall be deemed deleted, and the Anti-Corruption Code shall remain otherwise in full force and effect.
- 11.5 The Anti-Corruption Code is governed by and shall be construed in accordance with English law. Strictly without prejudice to the arbitration agreement set out in Articles 1.5, 5 and 7, the English courts shall have exclusive jurisdiction to issue relief in aid of that arbitration agreement and/or to hear and determine challenges to any decision issued by the Anti-Corruption Tribunal and/or the CAS.

APPENDIX 1

DEFINITIONS

Anti-Corruption Code. This Anti-Corruption Code promulgated by the ICC on the Effective Date.

ACU. See Anti-Corruption Unit.

Anti-Corruption Unit. The department within the ICC that is mandated, amongst other things, to monitor compliance with and investigate potential breaches of the Anti-Corruption Code.

ACU Chairman. The person appointed by the ICC from time to time to act as the Chairman of the ACU (or his/her designee).

ACU General Manager. An appointee of the ICC with supervisory responsibilities in relation to the Anti-Corruption Code (or his/her designee).

Agreed Sanction. As defined in Article 5.113.

Anti-Corruption Tribunal. A panel of three persons (subject to Article 5.16) appointed by the Chairman of the ICC Code of Conduct Commission, to perform the functions assigned to the Anti-Corruption Tribunal under the Anti-Corruption Code. Each member of the Anti-Corruption Tribunal shall be a member of the ICC Code of Conduct Commission and the ICC may provide reasonable compensation and reimbursement of expenses to such members.

Associate Member. Any National Cricket Federation with associate member status of the ICC.

Bet. Any wager, bet or other form of financial speculation.

CAS. The Court of Arbitration for Sport in Lausanne, Switzerland.

Code of Conduct. The ICC's Code of Conduct for Players and Player Support Personnel, as amended from time to time.

Corrupt Conduct. Any act or omission that would amount to an offence under Article 2 of this Anti-Corruption Code or the equivalent provisions of the anti-corruption rules of any National Cricket Federation.

Demand. As defined in Article 4.3.

Director. Each person serving as a director (including alternate director) or officer of the ICC, IBC, IDI or any Associated Company, including for the avoidance of doubt, the ICC Chairman and ICC Chief Executive as may be appointed from time to time.

Domestic Match. Any 'First-Class Match', 'List A Limited Overs Match', or 'List A Twenty20 Match', or any 'Other Match' played under the sole control and auspices of a National Cricket Federation and/or classified as Official Cricket by such National Cricket Federation, as those terms are defined in the ICC Classification of Official Cricket (as amended from time to time).

Effective Date. As defined in Article 11.3.

End Date. As defined in Article 1.7.

Full Member. Any National Cricket Federation with full member status of the ICC.

ICC. The International Cricket Council or its designee.

ICC's Chief Executive Officer. The person appointed by the ICC from time to time to act as the ICC's Chief Executive Officer (or his/her designee).

ICC's Clothing and Equipment Rules and Regulations. The ICC's Clothing and Equipment Regulations (a copy of which is set out in the ICC's Operating Manual), as amended from time to time.

ICC Code of Conduct Commission. An official committee of the ICC established, amongst other things, to provide independent enquiries, investigations and rulings in relation to matters brought to its attention. Each member of the ICC Code of Conduct Commission shall be independent of the ICC, which may provide reasonable compensation and reimbursement of expenses to such members.

ICC Code of Conduct for Umpires. The ICC's Code of Conduct for Umpires, as amended from time to time.

ICC Code of Ethics. The ICC's Code of Ethics, as amended from time to time.

ICC's Independent Oversight Group. An official committee of the ICC established, amongst other things, to assist and guide the ACU Chairman and the ACU General Manager on the development and implementation of the overall strategy adopted by the sport of cricket in dealing with the threat of corruption to the game.

ICC Events. Each of the following: (a) the ICC Cricket World Cup; (b) the ICC World Twenty20; (c) the ICC Champions Trophy; (d) the ICC World Cricket League Divisions 1-8 (inclusive), and any regional qualifying events thereto; (e) the ICC Women's Cricket World Cup; (f) the ICC Under 19 Cricket World Cup; (g) the ICC World Cup Qualifying Tournament; (h) the ICC Women's Cricket World Cup Qualifying Tournament, and any regional qualifying events thereto; (i) the ICC World Twenty20 Qualifying Tournament; (j) the ICC Under 19 Cricket World Cup Qualifying Tournament, and any regional qualifying events thereto; (k) the ICC Intercontinental Cup and Shield; and (l) any other event organised or sanctioned by the ICC from time to time to which the ICC deems it appropriate that the Anti-Corruption Code should apply.

ICC Official. Any individual bound by the ICC Code of Ethics, including, without limitation, Directors.

ICC's General Counsel. The person appointed by the ICC from time to time to act as the ICC's General Counsel (or his/her designee).

ICC's Minimum Standards for Players and Match Officials Area. The ICC's Minimum Standards for Players and Match Officials Area (a copy of which is set out in the ICC's Operating Manual), as amended from time to time.

ICC's Policy on Member Associations with Betting Companies. The ICC's Policy on Member Associations with Betting Companies (a copy of which is set out in the ICC's Operating Manual), as amended from time to time.

ICC's Operating Manual. The ICC's Official Operating Manual, as amended from time to time.

Ineligibility. The Participant being barred for a specified period of time from participation in the sport of cricket, as set out more specifically in Article 6.5.

Inside Information. Any information relating to any Match that a Participant possesses by virtue of his/her position within the sport. Such information includes, but is not limited to, factual information regarding the competitors in the Match, the conditions, tactical considerations or any other aspect of the Match, but does not include any such information that is already published or a matter of public record, that may be readily acquired by an interested member of the public, or that has been disclosed according to the rules and regulations governing the relevant Match.

International Match. Each of the following (in men's and women's cricket): (a) any Test Match, One Day International Match or Twenty20 International Match; (b) any Match played as part of an ICC Event; (c) any other Match played between representative sides of any National Cricket Federation at Under 19 level or above; (d) any International Tour Match; and (e) any other Match organised or sanctioned by the ICC from time to time to which the ICC deems it appropriate that the Anti-Corruption Code should apply.

International Tour Match. Any Match played between a representative team of a Full Member (or Associate Member with Test and/or ODI or T20I Status) and any domestic, guest or invitational team.

Match. A cricket match of any format and duration in length in which two cricket teams compete against each other either at international level (i.e., an International Match), including an International Tour Match) or at national level (i.e., a Domestic Match).

Match Referee. Any independent person (a) who is appointed (or who has been appointed in the preceding twenty-four (24) months) by the ICC or any other relevant party as the official match referee for a designated International Match or Domestic Match, whether such Match Referee carries out his/her functions remotely or otherwise, and/or (b) who is subject to an unexpired period of Ineligibility imposed on him/her pursuant to this Anti-Corruption Code and/or any other anti-corruption rules of any National Cricket Federation.

Mobile Device. Any portable device (including, without limitation, a personal digital assistant (PDA), blackberry, mobile phone, iPhone, iPad or iWatch) which is capable of connecting to or using any mobile telecommunications technology to enable or facilitate transmission of textual material, data, voice, video or multimedia services.

National Cricket Federation. A national or regional entity that is a member of or is recognised by the ICC as the entity governing the sport of cricket in a country (or collective group of countries associated for cricket purposes).

Notice of Charge. As defined in Article 4.6.

One Day International Match. As defined by Section 33 (ICC Classification of Official Cricket) of the ICC's Operating Manual.

Pitch Curator. Any individual who acts as a pitch curator or groundsman (or who has acted in such capacity at any time in the preceding twenty-four (24) months) at any stadium or venue affiliated (whether through a club, franchise, county, province or otherwise) to any National Cricket Federation.

Player. As defined in Article 1.4.1.

Player Agent. Any individual who acts in any way (or who has acted in any way in the preceding twenty-four (24) months) in the capacity of agent, representative, adviser or otherwise in relation to the negotiation, arrangement, registration of execution of any employment or commercial agreement for a Player, irrespective of whether such individual is registered or licensed to perform such activity within a National Cricket Federation or not.

Player Support Personnel. As defined in Article 1.4.2.

Provisional Hearing. For purposes of Article 4.7, an expedited abbreviated hearing before the Chairman of the ICC Code of Conduct Commission (sitting alone) that provides the Participant with notice and an opportunity to be heard in either written or oral form on whether or not the Provisional Suspension imposed on him/her should be lifted.

Provisional Suspension. The Participant being temporarily barred from participating in the sport of cricket pending determination of a charge that he/she has committed an offence under the Anti-Corruption Code, as set out more specifically in Article 4.7.

Reward. A person acts "for Reward" if he/she arranges or agrees that he/she or some other third party will receive any direct or indirect financial or other benefit for that act (other than official prize money and/or contracted payments under playing, service, endorsement, sponsorship or other such similar contracts), and the term "Reward" shall be construed accordingly.

Substantial Assistance. To qualify as Substantial Assistance for purposes of Article 6.1.2, a Participant must: (a) fully disclose in a signed witness statement all information that he/she possesses in relation to offences under the Anti-Corruption Code and/or that the ACU reasonably considers may be helpful to it in its enforcement of the Anti-Corruption Code; and (b) reasonably cooperate upon request by the ICC or any criminal or regulatory authority with the investigation and adjudication of any case related to that information, including (for example) presenting truthful testimony at a hearing if requested to do so.

Test Match. As defined by Section 33 (ICC Classification of Official Cricket) of the ICC's Operating Manual.

Twenty20 International Match. As defined by Section 33 (ICC Classification of Official Cricket) of the ICC's Operating Manual.

Umpire. Any umpire (including any on-field umpire, television umpire, third or fourth umpire) (a) who is appointed (or who has been appointed in the preceding twenty-four (24) months) by the ICC or any other relevant party to officiate in International Matches and/or Domestic Matches, and/or (b) who is subject to an unexpired period of Ineligibility imposed on him/her pursuant to this Anti-Corruption Code and/or any other anti-corruption rules of any National Cricket Federation.

Umpire Support Personnel. Any technical official (for example, and without limitation, any official with responsibility for operating the communication equipment for Umpires and Match Referees during an International Match or Domestic Match) or umpire coach (a) who is appointed (or who has been appointed in the preceding twenty-four (24) months) by the ICC or any other relevant party to support the Umpires and/or Match Referees in their appointments to any International Match or Domestic Match, and/or (b) who is subject to an unexpired period of Ineligibility imposed on him/her pursuant to this Anti-Corruption Code and/or the anti-corruption rules of any National Cricket Federation.

ICC REGULATIONS FOR THE REVIEW OF BOWLERS REPORTED WITH SUSPECT ILLEGAL BOWLING ACTIONS

ICC REGULATIONS FOR THE REVIEW OF BOWLERS WITH SUSPECTED ILLEGAL BOWLING ACTIONS

DEFINITIONS

In these Illegal Bowling Regulations the following words and phrases have the following meanings:

Accredited Testing Centre: any laboratory or testing centre accredited by the ICC to conduct analysis of bowling actions pursuant to the ICC Standard Analysis Protocols.

Appointed Specialist: as defined in Article 4.1.4 and paragraph 1 of Annexure 1.

Effective Date: as defined in Article 13.3.

Elbow Extension: the motion that occurs when a Player's arm moves from a flexed (bent) position at the elbow, to a more extended (straight) position (full Elbow Extension occurs when the arm is straight).

Elbow Hyperextension: the motion that occurs when a Player's elbow extends beyond the straight position.

Event Panel: as defined in Article 4.9.

Event Panel Analysis: as defined in Article 4.9.

Event Panel Report: as defined in Article 5.7.

Expert Panel: as defined in Article 4.7.

Expert Panel Analysis: as defined in Article 4.7.

Expert Panel Report: as defined in Article 5.5.

ICC: the International Cricket Council or its designee.

ICC Panel of Human Movement Specialists: the panel of appropriately qualified independent expert human movement specialists appointed by the ICC for the purposes of these Illegal Bowling Regulations.

Illegal Bowling Action: as defined in Article 2.1.

Independent Assessment: as defined in Article 4.1.

Independent Assessment Report: as defined in Article 5.1.

International Cricket: (a) Test Matches, One Day International Matches and Twenty20 International Matches (Men's and Women's); and (b) Matches that form part of the following ICC events (Men's and Women's) (whether or not such Match also constitutes a One Day or Twenty20 International) ICC Under 19 Cricket World Cup, ICC World Cricket League Championship, ICC Cricket World Cup Qualifier, ICC World Twenty20 Qualifier, ICC Under 19 Cricket World Cup Global Qualifier, ICC Intercontinental Cup and any other event organised or sanctioned by the ICC from time to time to which the ICC deems it appropriate that these Illegal Bowling Regulations should apply.

Judicial Commissioner: the independent person appointed by the ICC from the ICC Code of Conduct Commission to perform the functions assigned to the Judicial Commissioner pursuant to Article 8.

Major ICC Event: the ICC Cricket World Cup (Men's and Women's), the ICC Champions Trophy and/or the ICC World Twenty20 (Men's and Women's).

Match: any match played in International Cricket (excluding warm-up and practice matches).

Match Officials' Report: as defined in Article 3.1.

Match Referee: the referee who is appointed for and in attendance at the relevant Match. A Match Referee operating remotely shall not be considered a Match Referee for the purposes of these Illegal Bowling Regulations.

National Cricket Federation: the member board recognised by the ICC as the entity governing the sport of cricket in a country (or collective group of countries associated for cricket purposes) that the Player represents in International Cricket.

Notice of Appeal: as defined in Article 8.3.

One Day International Match: as defined by Section 33 (ICC Classification of Official Cricket) of the ICC's Operating Manual.

Other International Match: a Match that is not a Test Match, One Day International Match or Twenty20 International Match and that is not part of a Specified Event.

Player Attendance Form: the form signed by the Player confirming their attendance at and the date of an Independent Assessment.

Player(s): a cricketer who participates or has participated in International Cricket.

Re-Assessment: as defined in Article 4.5.

Specific Variation: a mode of delivery that is identifiably and significantly different from a bowler's Standard Delivery Type in respect of either the pace of the delivery, the axis or amount of rotation imparted on the ball and/or the method of release of the ball from the hand. Deliveries where a Player's basic bowling technique is accompanied by additional effort in order to produce a modified version of a Player's Standard Delivery Type (such as a bouncer or yorker length delivery) do not constitute Specific Variations.

Specified Event(s): the ICC Under 19 Cricket World Cup, the ICC Cricket World Cup Qualifier (Men's and Women's) and the ICC World Twenty20 Qualifier (Men's and Women's).

Standard Analysis Protocols: the ICC Standardised Protocols for the Assessment of Suspected Illegal Bowling Actions, as may be amended from time to time, which sets out the test methods and protocols developed for and on behalf of the ICC to analyse bowling actions, a summary of which is set out in Annexure 1.

Standard Delivery Type: the mode of delivery primarily used by a bowler, which shall include deliveries of different lines and lengths and from different positions on the crease, but which shall not include any Specific Variations.

Test Match: as defined by Section 33 (ICC Classification of Official Cricket) of the ICC's Operating Manual.

Testing Team: the individuals conducting an Independent Assessment, led by the Appointed Specialist.

Twenty20 International Match: as defined by Section 33 (ICC Classification of Official Cricket) of the ICC's Operating Manual, save that in the case of women's Twenty20 International Matches, only those Twenty20 International Matches played between the top ten ranked women's teams on the ICC's official Women's [Team/ODI] rankings as at the date of the relevant Match will be considered to fall within the definition of Twenty20 International Matches for the purposes of these Regulations.

Umpire: an on-field, TV or reserve umpire appointed to officiate in a Match in International Cricket.

INTRODUCTION

The ICC is responsible for the global governance of the sport of cricket. Historically, the regulation of what constitutes a legal bowling action has been governed by Law 21.2 of the Laws of Cricket, which state:

For a delivery to be fair in respect of the arm the ball must not be thrown; and

A ball is fairly delivered in respect of the arm if, once the bowler's arm has reached the level of the shoulder in the delivery swing, the elbow joint is not straightened partially or completely from that point until the ball has left the hand. This definition shall not debar a bowler from flexing or rotating the wrist in the delivery swing.

Scientific research revealed that almost all bowling actions contained some degree of straightening at the elbow (referred to in these Illegal Bowling Regulations as "Elbow Extension"). In theory, therefore, the vast majority of bowlers, with actions considered by umpires to be legal under the Laws of Cricket, were contravening Law 21.2 each time they delivered the ball. It was also demonstrated in studies by human movement specialists that such Elbow Extension in a bowling action became noticeable to the naked eye – and started to look like a throw – when it exceeded 15 degrees.

In order to ensure that the intention behind Law 21.2 was upheld and that the distinction between bowling and throwing the ball remained, the ICC has introduced regulations stipulating a maximum degree of permitted Elbow Extension in a bowling action. As with other regulations and Playing Conditions issued by the ICC, these Illegal Bowling Regulations modify the Laws of Cricket as applied to cricket played under the ICC's jurisdiction.

An Illegal Bowling Action is defined in these Illegal Bowling Regulations as a bowling action where a bowler's Elbow Extension exceeds 15 degrees, measured from the point at which the bowling arm reaches the horizontal until the point at which the ball is released (any Elbow Hyperextension shall be discounted for the purposes of determining an Illegal Bowling Action).

These Illegal Bowling Regulations have therefore been adopted and implemented by the ICC for the following reasons:

- i) to provide a consistent framework for the regulation of bowling actions;
- ii) to ensure a level playing field for cricket played under the ICC's jurisdiction, by ensuring that bowlers are not able to gain potential advantages through the use of an Illegal Bowling Action;
- iii) to provide a procedure under which both suspected and confirmed Illegal Bowling Actions in International Cricket can be dealt with fairly, efficiently and with certainty; and
- iv) to coordinate the approach taken in domestic cricket to the testing of suspected Illegal Bowling Actions – and the consequences of confirmed Illegal Bowling Actions – between National Cricket Federations and the ICC.

Unless otherwise indicated, references to Articles, Annexures and Appendices are to provisions of these Illegal Bowling Regulations. Capitalised words are defined terms and their definitions are set out above.

1 SCOPE AND APPLICATION

- 1.1 All Players are automatically bound by and required to comply with all of the provisions of these Illegal Bowling Regulations. Accordingly, by their participation in an International Match, such Players shall be deemed to have agreed:
 - 1.1.1 to submit to any Independent Assessment convened under these Illegal Bowling Regulations pursuant to a Match Officials' Report of a suspected Illegal Bowling Action;
 - 1.1.2 to submit to the jurisdiction of the Judicial Commissioner in respect of any Notice of Appeal pursuant to these Illegal Bowling Regulations;
 - 1.1.3 not to bring any proceedings in any court or other forum that are inconsistent with the foregoing submission to the jurisdiction of the Judicial Commissioner.
- 1.2 Without prejudice to Article 1.1, the ICC and the National Cricket Federations shall be responsible for promoting awareness of what constitutes an Illegal Bowling Action and these Illegal Bowling Regulations amongst all Players.

2 ILLEGAL BOWLING ACTIONS

- 2.1 An Illegal Bowling Action is a bowling action where the Player's Elbow Extension exceeds 15 degrees, measured using the Standard Analysis Protocols from the point at which the bowling arm reaches the horizontal until the point at which the ball is released. Any Elbow Hyperextension shall be discounted for the purposes of determining an Illegal Bowling Action.
- 2.2 Nothing contained herein shall override an Umpire's responsibility and discretion to apply Law 24 of the Laws of Cricket, as modified by Article 2.1 above.

3 REPORTING PROCEDURE FOR A SUSPECTED ILLEGAL BOWLING ACTION

- 3.1 Any one of the following individuals may, at the conclusion of a Match in which they have officiated, submit a report by completing the template ICC Bowling Action Report Form (a "**Match Officials' Report**"):
 - 3.1.1 an Umpire; and/or
 - 3.1.2 a Match Referee.
- 3.2 A Match Officials' Report shall be submitted where a Player is either called by an Umpire under the provisions of Law 24.2 of the Laws of Cricket or is suspected by an Umpire and/or the Match Referee of bowling with an Illegal Bowling Action. The Match Officials' Report shall detail their concerns about the bowling action of a Player including whether those concerns relate to the Player's Standard Delivery Type or one or more Specific Variations.

- 3.3 In considering whether to submit a Match Officials' Report under these Illegal Bowling Regulations, Umpires and Match Referees should use the naked eye viewing the Player's bowling action live and/or on video footage at normal speed. Slow motion video footage should only be used to confirm initial suspicions of a Player's use of an Illegal Bowling Action.

Test Matches, One Day International Matches and Twenty20 International Matches

- 3.4 Where a Match Officials' Report is submitted in relation to a Test Match, One Day International Match or Twenty20 International Match, the following procedure shall be applied:
 - 3.4.1 within 24 hours of the conclusion of the Match in which the Player is reported, the Umpire(s) and/or the Match Referee shall provide the Player's team manager and the ICC with a copy of the Match Officials' Report;
 - 3.4.2 once the Player's team manager and the ICC have been provided with a copy of the Match Officials' Report and within 24 hours thereof, the ICC shall make a media statement to the effect that the Player has been reported as having a suspected Illegal Bowling Action and shall be subject to the review process set out herein;
 - 3.4.3 the ICC shall immediately write to the Player's National Cricket Federation confirming that the Player has been reported for a suspected Illegal Bowling Action, enclosing the Match Officials' Report and informing the Player's National Cricket Federation that the Player shall be required to submit to an Independent Assessment in accordance with Article 4.1;
 - 3.4.4 if the Match was televised, upon receipt of the Match Officials' Report from the Match Referee, the ICC shall, as soon as possible, provide details to the Player's National Cricket Federation of a link at which video footage of the Player's bowling in the relevant Match (whether sourced from the television coverage of the Match or from a third party) can be downloaded;
 - 3.4.5 if no video footage is available and the ICC is unable to source adequate video footage of the Player's bowling in the Match from any third party, upon receipt of the Match Officials' Report from the Match Referee, the ICC shall immediately write to the Player's National Cricket Federation confirming that the Player has been reported for a suspected Illegal Bowling Action, enclosing the relevant Match Officials' Report and requesting that the National Cricket Federation provide to the ICC within 7 days any relevant video footage of the Player's bowling (whether in training or matches) that they are able to access.

Other International Matches

- 3.5 Where a Match Officials' Report is submitted in relation to an Other International Match, the following procedure shall be applied:
 - 3.5.1 within 48 hours of the conclusion of the Match in which the Player is reported, the Umpire(s) and/or the Match Referee shall provide the Player's team manager and the ICC with a copy of the Match Officials' Report;

- 3.5.2 once the Player's team manager and the ICC have been provided with a copy of the Match Officials' Report and within 24 hours thereof, the ICC shall make a media statement to the effect that the Player has been reported as having a suspected Illegal Bowling Action and shall be subject to the review process as set out herein;
- 3.5.3 upon receipt of the Match Officials' Report from the Umpire(s) and/or the Match Referee, the ICC shall immediately write to the Player's National Cricket Federation confirming that the Player has been reported for a suspected Illegal Bowling Action, enclosing a copy of the Match Officials' Report and informing the Player's National Cricket Federation that the Player's bowling action shall be reported to the Expert Panel for analysis;
- 3.5.4 if the Match in which the Player was reported was televised or if the ICC has otherwise been able to source adequate video footage of the Player's bowling, the ICC shall, as soon as possible, provide details to the Player's National Cricket Federation of a link at which a copy of video footage of the bowling of the Player in the relevant Match can be downloaded;
- 3.5.5 if no video footage is available, upon receipt of the Match Officials' Report from the Match Referee, the ICC shall immediately write to the Player's National Cricket Federation confirming that the Player has been reported for a suspected Illegal Bowling Action, enclosing the relevant Match Officials' Report and requesting that the National Cricket Federation provide to the ICC within 7 days any relevant video footage of the Player's bowling (whether in training or matches) that they are able to access;
- 3.5.6 if no such video footage is available, to assist with the Expert Panel Analysis, the Player's National Cricket Federation shall be required to arrange for all of the Player's bowling in their next Match or domestic match (whichever is the earlier) to be recorded in the manner determined and communicated to them by the ICC, and shall submit that video footage to the ICC within 48 hours of the conclusion of the relevant Match or domestic match;
- 3.5.7 In circumstances where the relevant Match was not televised and where the Player's National Cricket Federation fails to provide either acceptable video footage (in the ICC's sole discretion) or video footage of all the Player's bowling in their next match, whether international or domestic, within the period prescribed in Article 3.5.6 above, the Player shall automatically be suspended from bowling in International Cricket until such time as the Player submits to a review of their bowling action by an Expert Panel, with the precise terms of such review (including but not limited to a requirement that the Player's National Cricket Federation provide acceptable video footage prior to undertaking the review) to be determined by the Expert Panel in their sole discretion.

Specified Events

- 3.6 Where a Match Officials' Report is submitted in relation to a Match forming part of a Specified Event, the following procedure shall be applied:
- 3.6.1 within 24 hours of the conclusion of the Match in which the Player is reported, the Umpire(s) and/or the Match Referee shall provide the Player's team manager and the ICC with a copy of the Match Officials' Report. At the same time the ICC shall provide a copy of the Match Officials' Report to the Event Panel for analysis;
- 3.6.2 if the Match in which the Player was reported was televised, the ICC shall, as soon as possible, provide details to the Player's National Cricket Federation and the Event Panel of a link at which a copy of the video footage of the bowling of the Player in the relevant Match can be downloaded. If no video footage is available, the Event Panel shall make arrangements to record the Player's bowling in the next Match(es) in the Specified Event in which they participate. In addition, even where video footage of the Match in which the Player was reported is available, the Event Panel may, in their sole discretion, make arrangements to record the Player's bowling in the next Match(es) in the Specified Event in which they participate to assist them in their analysis. Copies of any video footage collated by the Event Panel pursuant to this Article 3.6.2 shall be made available to the Player's National Cricket Federation by the ICC via a download link, unless exceptional circumstances exist, as soon as reasonably practicable.

4 EVALUATION OF BOWLING ACTIONS

Independent Assessment

- 4.1 Where a Player is reported for a suspected Illegal Bowling Action pursuant to Article 3.4, they shall be required to submit to an independent analysis of their bowling action (the "Independent Assessment") which shall be carried out in accordance with the following procedure:
- 4.1.1 the Independent Assessment shall be carried out as soon as reasonably practicable and, unless exceptional circumstances exist, within 14 days of receipt by the Player's National Cricket Federation of the notice referred to in Article 3.4.3;
- 4.1.2 in the event of a Player being reported during a Match in a Major ICC Event, the Independent Assessment shall be carried out on an expedited basis. Accordingly, unless exceptional circumstances exist, the Independent Assessment shall be carried out within a period of 72 hours from the time of the ICC's receipt of the Match Officials' Report;
- 4.1.3 the ICC shall be responsible for liaising with the Player's National Cricket Federation in order to determine the date and time at which the Independent Assessment shall be carried out and shall ensure that the Player, through the Player's National Cricket Federation, is given reasonable notice thereof. All travel and accommodation arrangements shall be made by the ICC in consultation with the Player's National Cricket Federation;

- 4.1.4 the Independent Assessment shall be supervised by a member of the ICC Panel of Human Movement Specialists (the **"Appointed Specialist"**) appointed by the ICC in its sole discretion. The Independent Assessment shall take place at an Accredited Testing Centre, appointed by the ICC in consultation with the Player's National Cricket Federation;
- 4.1.5 when appointing an Appointed Specialist or an Accredited Testing Centre, the ICC's preference where possible will be to test the Player at an Accredited Testing Centre in a country other than their own country, and for the Independent Assessment to be conducted by an Appointed Specialist from a county other than the Player's. However, each Accredited Testing Centre is fully independent of the ICC and National Cricket Federations and therefore it may be necessary for an Independent Assessment to be conducted by an Appointed Specialist from the Player's home country, or at an Accredited Testing Centre in the Player's home country;
- 4.1.6 the Independent Assessment shall be carried out in accordance with the Standard Analysis Protocols set out in Annexure 1 and shall take into account the Match Officials' Report. During the Independent Assessment, the Player shall be required to replicate the specific bowling action for which they were reported. If the Player expresses any concern or complaint regarding the circumstances or conduct of the Independent Assessment, they should make these known to the Appointed Specialist before the completion of the Independent Assessment. The Player shall note the relevant concern or complaint on the Player Attendance Form, which the Appointed Specialist shall include with the Independent Assessment Report.
- 4.2 In the event of the Player failing to submit to the Independent Assessment within the deadlines referred to in Articles 4.1.1 and 4.1.2 by reason of any action, inaction or otherwise of the Player (including injury), they shall be immediately suspended from bowling in International Cricket until such time as they submit to an Independent Assessment which determines that they do not use an Illegal Bowling Action. If the Independent Assessment does not take place within the stipulated deadline by reason of any action, inaction or otherwise of the ICC, the Player shall not be suspended pursuant to this Article 4.2.
- 4.3 Subject to the provisions of Article 4.2 above and Article 4.4 below, throughout the period up to the date of receipt by the Player's National Cricket Federation of the validated Independent Assessment Report, the Player shall be permitted to continue bowling in International Cricket. At any time throughout this period the Player is subject to being called on the field by the Umpire(s) in accordance with Law 24.2 and the consequences of being called under Law 24.2 shall apply. During this period a further Match Officials' Report shall, however, have no consequence.
- 4.4 A Player who is the subject of a Match Officials' Report in an Other International Match or a Specified Event shall, irrespective of the conclusion of the Expert Panel or Event Panel (as applicable), not be permitted to bowl in a Major ICC Event without submitting to an Independent Assessment which results in a validated Independent Assessment Report that determines that the Player is able to bowl without using an Illegal Bowling Action.

Re-Assessment

- 4.5 Subject to the provisions of Article 6.12 (in which case a period of 1 year from the date of suspension must be observed), a Player who has been suspended from bowling in International Cricket under these Illegal Bowling Regulations (or from a National Cricket Federation's domestic cricket pursuant to Article 10.2) may, at any time, apply to the ICC for an independent re-assessment of their bowling action (a **"Re-Assessment"**), which shall be carried out in accordance with the procedure for the Independent Assessment in Article 4.1 above, save that:
- 4.5.1 the Player shall be required to identify, prior to the Re-Assessment, their Standard Delivery Type and any Specific Variations which they wish to bowl during the Re-Assessment;
- 4.5.2 Article 5.2.1, Article 5.2.4 and Article 6.1.2 shall not be applicable; and
- 4.5.3 all provisions of the Standard Analysis Protocols relating to the replication of a Player's previous match bowling action shall not be applicable.
- 4.6 The validated Independent Assessment Report resulting from the Re-Assessment shall stand in the place of the original validated Independent Assessment Report, Expert Panel Report and/or Event Panel Report (as applicable) and the provisions of these Illegal Bowling Regulations shall apply in respect of it. The validated Independent Assessment Report resulting from such Re-Assessment (and, where deemed appropriate by the ICC, video footage from the Re-Assessment) shall be made available by the ICC to relevant Umpires and/or Match Referees.

Expert Panel Analysis

- 4.7 Where a Player is reported for a suspected Illegal Bowling Action pursuant to Article 3.5, the Match Officials' Report shall be referred to a panel of two members of the ICC Panel of Human Movement Specialists (the **"Expert Panel"**) to conduct a review of the Player's bowling action (the **"Expert Panel Analysis"**), which shall be carried out in accordance with the following procedure:
- 4.7.1 the Expert Panel shall be appointed by the ICC within 48 hours of the ICC's receipt of the Match Officials' Report. The members of the Expert Panel shall, wherever possible, be from countries other than the country that the Player represents in International Cricket;
- 4.7.2 in order to conduct their review, the Expert Panel shall review either the video footage of the Player's bowling in the Match in which the Player was reported or the video footage provided by the Player's National Cricket Federation in accordance with Articles 3.5.6 and 3.5.7 (as applicable) in order to conclude (unanimously) whether the Player bowls with an Illegal Bowling Action;
- 4.7.3 the Expert Panel shall carry out its review (whether in person or via telephone or video-conference) as soon as reasonably practicable and, unless exceptional circumstances exist, within 7 days of either (a) in the case of a televised Match, receipt by the Player's National Cricket Federation of the notice referred to in Article 3.5.3, or (b) in the case of a non-televised Match, the ICC's receipt of the video footage from the Player's National Cricket Federation pursuant to Articles 3.5.6 and 3.5.7;

4.7.4 in considering the video footage of the Player and conducting its analysis the Expert Panel shall use its experience and technical expertise to arrive at an assessment of whether the Player uses an Illegal Bowling Action as defined within these Illegal Bowling Regulations;

4.8 Subject to the provisions of Article 4.4, throughout the period up to the date of receipt of the Expert Panel Report, the Player shall be permitted to continue bowling in International Cricket. At any time throughout this period the Player is subject to being called on the field by the Umpire(s) in accordance with Law 24.2 and the consequences of being called under Law 24.2 shall apply. During this period a further Match Officials' Report shall, however, have no consequence.

Event Panel Analysis

4.9 Where a Player is reported for a suspected Illegal Bowling Action pursuant to Article 3.6, the Match Officials' Report shall be referred to the bowling action review panel appointed by the ICC in advance of the relevant Specified Event (the "Event Panel", which shall comprise of at least two and at a maximum three members) to conduct a review of the Player's bowling action (the "Event Panel Analysis").

4.10 The members of the Event Panel shall be drawn from any one or more of the following: the ICC Panel of Human Movement Specialists, the ICC's High Performance Manager or any other independent persons with the relevant area of expertise as may be required in the opinion of the ICC General Manager – Cricket. Members of the Event Panel may be in attendance at the Specified Event, or they may operate remotely to undertake the Event Panel Analysis, which shall be carried out in accordance with the following procedure:

4.10.1 the Event Panel shall carry out the Event Panel Analysis as soon as reasonably practicable and, unless exceptional circumstances exist, within 3 days of their receipt of the Match Officials' Report;

4.10.2 in order to conduct their analysis, the Event Panel shall review either the video footage of the Player's bowling in the Match in which the Player was reported, if available, and/or the video footage of the Player's bowling action that they have collated themselves in order to use their experience and technical expertise to arrive at a conclusion as to whether the Player uses an Illegal Bowling Action as defined within these Illegal Bowling Regulations;

4.11 Subject to the provisions of Article 4.4, throughout the period up to the date of receipt of the Event Panel Report, the Player shall be permitted to continue bowling in International Cricket. At any time throughout this period the Player is subject to being called on the field by the Umpire(s) in accordance with Law 24.2 and the consequences of being called under Law 24.2 shall apply. During this period a further Match Officials' Report shall, however, have no consequence.

5 FORMAT OF RESULTS

Independent Assessment

5.1 As soon as reasonably possible and, unless exceptional circumstances exist, at the latest within 10 days of the date on which the Independent Assessment or Re-Assessment was carried out, the Appointed Specialist shall provide the ICC with a detailed written report (the "Independent Assessment Report") in the form prescribed by the ICC and set out at Appendix 1.

5.2 The Independent Assessment Report shall indicate:

5.2.1 whether the Player's bowling action during the Independent Assessment was, in the opinion of the Appointed Specialist, materially different to their bowling action in the video footage from the Match in which the Match Officials' Report was submitted (both in respect of their Standard Delivery Type and any Specific Variations (if any) identified in the Match Officials' Report);

5.2.2 the Elbow Extension measured in the Independent Assessment in respect of their Standard Delivery Type;

5.2.3 the Elbow Extension measured in the Independent Assessment in respect of each Specific Variation;

5.2.4 whether, in the opinion of the Appointed Specialist, the conclusion in Articles 5.2.2 and 5.2.3 above is consistent with the relevant video footage provided pursuant to Articles 3.4.4 and 3.4.5.

5.3 Immediately upon receipt of the Independent Assessment Report, the ICC shall send the Independent Assessment Report to at least one member of the ICC Panel of Human Movement Specialists (who shall not have had any prior involvement with the case) for review and validation of the determination in the Independent Assessment Report as to whether the Player uses an Illegal Bowling Action.

5.4 Immediately upon receipt of the validated Independent Assessment Report and regardless of the determination contained therein in respect of the use of an Illegal Bowling Action, the ICC shall provide the Player's National Cricket Federation with a copy thereof.

Expert Panel Report

5.5 The Expert Panel shall, unless exceptional circumstances exist, provide a written report to the ICC (the "Expert Panel Report") within 14 days of either (a) in the case of a televised Match, receipt by the Player's National Cricket Federation of the notice referred to in Article 3.5.3, or (b) in the case of a non-televised Match, receipt of the video footage provided by the National Cricket Federation pursuant to Articles 3.5.6 and 3.5.7. The Expert Panel Report shall contain:

5.5.1 details of the Match following which the relevant Match Officials' Report was submitted;

5.5.2 details of any relevant observations made by the Umpires and/or Match Referee in the Match Officials' Report in relation to the Player's bowling action;

5.5.3 relevant still images from the video footage examined by the Expert Panel;

- 5.5.4 an analysis of the degree of Elbow Extension used by the Player in their bowling action;
 - 5.5.5 a conclusion as to whether the Player uses an Illegal Bowling Action as defined in Article 2.1 of these Illegal Bowling Regulations.
- 5.6 Upon receipt of the Expert Panel Report, the ICC shall immediately write to the Player's National Cricket Federation enclosing a copy of the Expert Panel Report and confirming the outcome thereof.

Event Panel Report

- 5.7 The Event Panel shall provide a written report to the ICC (the “**Event Panel Report**”), unless exceptional circumstances exist, within 7 days of receipt by them of the Match Officials’ Report. The Event Panel Report shall contain:
- 5.7.1 details of the Match following which the relevant Match Officials’ Report was submitted;
 - 5.7.2 details of any relevant observations made by the Umpires and/or Match Referee in the Match Officials’ Report in relation to the Player’s bowling action;
 - 5.7.3 relevant still images from the video footage examined by the Expert Panel;
 - 5.7.4 an analysis of the degree of Elbow Extension used by the Player in their bowling action;
 - 5.7.5 a conclusion as to whether the Player uses an Illegal Bowling Action as defined in Article 2.1 of these Illegal Bowling Regulations.
- 5.8 Upon receipt of the Event Panel Report, the ICC shall immediately write to the Player’s National Cricket Federation enclosing a copy of the Event Panel Report and confirming the outcome thereof.

6 CONSEQUENCES OF RESULTS

Independent Assessment

- 6.1 Subject to Article 6.2 below, where the validated Independent Assessment Report determines either:
- 6.1.1 that the Player used an Illegal Bowling Action in respect of their Standard Delivery Type during the Independent Assessment and that such conclusion is consistent with the relevant video footage; or
 - 6.1.2 that the Player’s bowling action during the Independent Assessment was materially different to their bowling action in the Match in respect of which the relevant Match Officials’ Report was submitted,

the Player shall immediately be suspended from bowling in International Cricket. The suspension shall be effective from the date of receipt by the Player’s National Cricket Federation of a copy of the validated Independent Assessment Report pursuant to Article 5.4.

- 6.2 Where the validated Independent Assessment Report determines that the Player used an Illegal Bowling Action during the Independent Assessment in respect of one or more Specific Variations only (and that their Standard Delivery Type did not use an Illegal Bowling Action) the Player shall be allowed to continue bowling in International Cricket, subject to the warning that should they continue to bowl the Specific Variation(s) for which they have been found to have an Illegal Bowling Action, they will run the risk of being reported for a second time. In these circumstances a further Match Officials’ Report resulting in a validated Independent Assessment Report determining that the Player has used an Illegal Bowling Action for a Specific Variation shall result in the immediate suspension of the Player from bowling in International Cricket. Such suspension shall be considered a second suspension under the provisions of Article 6.12.
- 6.3 Where a validated Independent Assessment Report determines that the Player does not use an Illegal Bowling Action, the Player shall be permitted to continue bowling in International Cricket. The ICC shall communicate this determination to any relevant National Cricket Federations, Umpires and/or Match Referees and shall as soon as reasonably practicable issue a media statement to the effect that the Player has been determined by an Independent Assessment not to use an Illegal Bowling Action.
- 6.4 In the event of a Re-Assessment conducted pursuant to Article 4.5 determining that the Player is able to bowl without using an Illegal Bowling Action, the Player’s suspension shall be lifted and they shall be permitted to resume bowling in International Cricket immediately. The ICC shall communicate this determination to any relevant National Cricket Federations, Umpires and/or Match Referees and shall as soon as reasonably practicable issue a media statement to the effect that, upon Re-Assessment, the Player has been determined by an Independent Assessment to be able to bowl without using an Illegal Bowling Action.

Expert Panel Analysis

- 6.5 Where the Expert Panel Report concludes that the Player uses an Illegal Bowling Action, the Player shall be immediately suspended from bowling in International Cricket.
- 6.6 Where the Expert Panel Report concludes that the Player does not use an Illegal Bowling Action, the Player shall be permitted to continue bowling in International Cricket.

Event Panel Analysis

- 6.7 Where the Event Panel Report concludes that the Player uses an Illegal Bowling Action, the Player shall be immediately suspended from bowling in International Cricket.
- 6.8 Where the Event Panel Report concludes that the Player does not use an Illegal Bowling Action, the Player shall be permitted to continue bowling in International Cricket.

Disputing an Expert Panel Report or Event Panel Report

- 6.9** Where an Expert Panel Report or an Event Panel Report concludes that the Player uses an Illegal Bowling Action, if the Player and/or their National Cricket Federation disputes that conclusion, the Player and/or their National Cricket Federation shall so notify the ICC within 7 days of receipt by the Player's National Cricket Federation of the Expert Panel Report or Event Panel Report (as applicable) and notify the ICC that consequently the Player shall submit as soon as practicable, at the Player's or the National Cricket Federation's cost, to an Independent Assessment conducted by an Appointed Specialist at an Accredited Testing Centre in line with the Standard Analysis Protocols.
- 6.10** If the validated Independent Assessment Report resulting from an Independent Assessment conducted pursuant to Article 6.9 above determines that the Player does not use an Illegal Bowling Action, the Player's suspension from bowling in International Cricket shall be immediately lifted and they shall be permitted to resume bowling in International Cricket immediately.
- 6.11** If the validated Independent Assessment Report resulting from an Independent Assessment conducted pursuant to Article 6.9 above determines that the Player uses an Illegal Bowling Action, the suspension imposed pursuant to Article 6.5 or Article 6.7 (as applicable) shall remain in force.

Second and subsequent reports

- 6.12** In the event of a Player being suspended from bowling in International Cricket under these Illegal Bowling Regulations for a second time within a period of 2 years from the date of the commencement of the first period of suspension, the Player shall be automatically suspended from bowling in International Cricket for a minimum period of 1 year.
- In the event of a Player being suspended from bowling in International Cricket under these Illegal Bowling Regulations for a third time, the Player shall be automatically suspended from bowling in International Cricket for a minimum period of 2 years.

7 LIFTING OF SUSPENSION

Independent Assessment

- 7.1** A suspension imposed as a result of an Independent Assessment pursuant to Article 4.1 or Article 4.5 shall remain in place until such time as the Player has submitted to a Re-Assessment in accordance with the provisions set out in Article 4.5 and, in a validated Independent Assessment Report resulting from such Re-Assessment, it is determined that the Player is able to bowl without using an Illegal Bowling Action, whereupon the Player shall be permitted to resume bowling in International Cricket immediately.
- 7.2** Only after the expiry of the 1 year period of suspension imposed pursuant to Article 6.12 shall a Player be permitted to apply to the ICC for a Re-Assessment in accordance with Article 4.5.

Expert Panel Analysis

- 7.3** A suspension imposed as a result of an Expert Panel Report pursuant to Article 5.5 (and which is not disputed by the Player and/or their National Cricket Federation in accordance with Article 6.9) shall remain in force until such time as either (a) the Player undertakes a review of their bowling action by a further Expert Panel (the precise terms of which shall be determined by the Expert Panel in their sole discretion) which concludes that they are able to bowl without using an Illegal Bowling Action or (b) the Player, at their or their National Cricket Federation's own cost, submits to a Re-Assessment conducted by an Appointed Specialist at an Accredited Testing Centre pursuant to Article 4.5 and a validated Independent Assessment Report resulting from such Re-Assessment determines that they are able to bowl without using an Illegal Bowling Action, whereupon the Player shall be permitted to resume bowling in International Cricket immediately.
- 7.4** If the validated Independent Assessment Report resulting from a Re-Assessment conducted pursuant to Article 7.3 above determines that the Player uses an Illegal Bowling Action, the suspension imposed shall remain in force.

Event Panel Analysis

- 7.5** A suspension imposed as a result of an Event Panel Report pursuant to Article 5.7 (and which is not disputed by the Player and/or their National Cricket Federation in accordance with Article 6.9) shall remain in force until such time as the Player, at their or their National Cricket Federation's cost, submits to a Re-Assessment conducted by an Appointed Specialist at an Accredited Testing Centre pursuant to Article 4.5 and a validated Independent Assessment Report resulting from such Re-Assessment determines that they are able to bowl without using an Illegal Bowling Action, whereupon the Player shall be permitted to resume bowling in International Cricket immediately.
- 7.6** If the validated Independent Assessment Report resulting from a Re-Assessment conducted pursuant to Article 7.5 above determines that the Player uses an Illegal Bowling Action, the suspension imposed shall remain in force.

8 APPEALS

- 8.1** A determination that a Player uses an Illegal Bowling Action as a result of a validated Independent Assessment Report following an Independent Assessment conducted by an Accredited Testing Centre in accordance with the Standard Analysis Protocols shall not be subject to further review. As such, a Player and/or their National Cricket Federation shall not be entitled to appeal the scientific basis for a validated Independent Assessment Report.
- 8.2** However, in circumstances where a Player and/or their National Cricket Federation contend that the ICC has not followed its own procedures under these Illegal Bowling Regulations and such failure has had a material effect upon the validated Independent Assessment Report, the Player and/or their National Cricket Federation shall be entitled to seek a review of the procedural aspects of their case by way of a Notice of Appeal to a Judicial Commissioner, in accordance with Article 8.3.

- 8.3** A Player and/or their National Cricket Federation seeking a review of their case shall lodge written notice thereof with the ICC's General Counsel (with a copy to the ICC's General Manager – Cricket) within 7 days of receipt by the Player's National Cricket Federation of the validated Independent Assessment Report (the "**Notice of Appeal**"). The Notice of Appeal shall include a written statement setting out, in detail, the grounds for the review of the suspension, together with any documents that the Player wishes to rely on in support of such review.
- 8.4** Upon receipt of a Notice of Appeal, the ICC's General Counsel shall, as soon as reasonably practicable, appoint one member of the ICC's Code of Conduct Commission, who shall be from a country other than that of the Player, to act as the Judicial Commissioner and hear the case, sitting alone.
- 8.5** The procedure for the review (including whether to convene a hearing or, alternatively, to determine the matter, or any part thereof, by way of written submissions alone) shall be at the discretion of the Judicial Commissioner, provided that the review is conducted in a manner that affords the Player a fair and reasonable opportunity to present evidence (including the right to call and question witnesses by telephone or video-conference where necessary), address the Judicial Commissioner and present their case. The Player shall be entitled to a representative during the review process, who shall be entitled to attend any hearing.
- 8.6** In circumstances where the Judicial Commissioner determines that a hearing should be held, the Player shall, where possible, attend the hearing. The ICC shall be responsible for making the necessary arrangements for the hearing and shall ensure that the Player, through the Player's National Cricket Federation, is given reasonable notice of the relevant arrangements. If the Player has received notice of the hearing and fails to attend, the hearing may, at the sole discretion of the Judicial Commissioner, proceed in the absence of the Player.
- 8.7** The Judicial Commissioner may, at any time during the process and at their sole discretion, seek expert advice, at the ICC's cost, from a human movement specialist (who may be a member of the ICC Panel of Human Movement Specialists), to assist them in their deliberations.
- 8.8** The Judicial Commissioner shall decide whether or not the review of the Player and/or their National Cricket Federation to the procedure should be upheld and, if so, what the consequences, if any, are of that decision. These may include, without limitation, upholding the Player's review and, where the Judicial Commissioner considers that such procedural defect is of such a serious nature that it materially affected the outcome of the Independent Assessment (and consequently, that the validated Independent Assessment Report cannot be considered reliable), amending the results of the Independent Assessment. The Judicial Commissioner shall, in each case, set out the reasons why the decision has been reached, including a summary of the evidence on which the decision was based.
- 8.9** The ICC shall communicate the decision of the Judicial Commissioner in writing to the Player, through their National Cricket Federation, within 48 hours of its receipt of the Judicial Commissioner's decision.
- 8.10** Subject to the right of the Player to apply to the ICC for a Re-Assessment in accordance with Article 4.5, the decision of the Judicial Commissioner shall be final and binding.

9 COSTS

Independent Assessment

- 9.1** The ICC shall be responsible for the costs incurred by the Player in attending an initial Independent Assessment.

Re-Assessments

- 9.2** The Player and/or the Player's National Cricket Federation shall be responsible for the costs incurred by the Player in attending any Re-Assessments carried out pursuant to Article 4.5.

Independent Assessments Subsequent to Expert Panel Report or Event Panel Report

- 9.3** Where a validated Independent Assessment Report pursuant to Article 6.9 determines that a Player suspended as a result of an Expert Panel Report or Event Panel Report does not use an Illegal Bowling Action, the costs of such Independent Assessment incurred by the Player and/or their National Cricket Federation, including the costs incurred by the Player to attend, shall be reimbursed by the ICC to the Player's National Cricket Federation upon production of valid receipts.

Appeals

- 9.4** The ICC shall be responsible for the costs incurred by the Player in attending any hearing before a Judicial Commissioner.
- 9.5** The costs incurred by the Player and/or their National Cricket Federation for any representation at such a hearing before a Judicial Commissioner shall be borne by the Player and/or their National Cricket Federation.

10 NATIONAL CRICKET FEDERATION POLICY

- 10.1** All National Cricket Federations shall formulate and implement a policy and strategy in the form of procedures to deal with players with suspected Illegal Bowling Actions in their domestic cricket. It is the responsibility of National Cricket Federations to ensure that bowlers with suspected Illegal Bowling Actions are closely monitored and scrutinised before being picked to represent the National Cricket Federation in International Cricket.
- 10.2** Where a National Cricket Federation's procedures for dealing with players with suspected Illegal Bowling Actions involve the assessment of such players' actions conducted at an Accredited Testing Centre using the Standard Analysis Protocols and conducted pursuant to these Illegal Bowling Regulations, the National Cricket Federation shall ensure that the results of such assessments are interpreted in the same way as if the assessment was conducted pursuant to these Illegal Bowling Regulations.
- 10.3** A National Cricket Federation may provide the ICC with the full report from any such assessments undertaken and, upon receipt of such information, the ICC shall maintain appropriate records. However, whilst the ICC may choose to communicate such information to Umpires and Match Referees where it considers this relevant and appropriate, it shall be under no obligation to do so. Further, the results of any assessments conducted by a National Cricket Federation shall not preclude any Player in International Cricket from either being called by an Umpire under the provisions of Law 24.2 of the Laws of Cricket or being reported for a suspected Illegal Bowling Action under these Illegal Bowling Regulations.

11 RECOGNITION OF DECISIONS

- 11.1** A suspension from bowling in International Cricket imposed on a Player under these Illegal Bowling Regulations shall be respected and enforced by all National Cricket Federations in respect of domestic cricket under their jurisdiction automatically upon receipt of notice of the same, without the need for any further formality. All National Cricket Federations shall take all steps legally available to them to enforce and give effect to such decisions.
- 11.2** Upon a suspension from bowling in International Cricket being lifted, whether as a result of a validated Independent Assessment Report or an Expert Panel Report, a Player shall be permitted to bowl in all domestic cricket under the auspices of all National Cricket Federations without the need for any further formality.
- 11.3** In circumstances where a National Cricket Federation suspends a player from bowling in domestic cricket under its own rules, where such suspension is imposed on the basis of an analysis of the respective player conducted by an Accredited Testing Centre and in accordance with the Standard Analysis Protocols, such suspension shall be respected and enforced by the ICC in International Cricket and all National Cricket Federations in respect of domestic cricket under their jurisdiction automatically upon receipt of notice of the same, without the need for any further formality. The ICC and National Cricket Federations shall take all steps legally available to them to enforce and give effect to such decisions.
- 11.4** Where a player has been suspended pursuant to Article 11.3, the player may submit at any time to a further analysis of their bowling action arranged by the same National Cricket Federation and conducted at an Accredited Testing Centre in accordance with the Standard Analysis Protocols. Where such further analysis determines that they are able to bowl without using an Illegal Bowling Action, the player shall be permitted to bowl by the ICC in International Cricket and by all National Cricket Federations in their own domestic cricket without the need for any further formality.
- 11.5** Notwithstanding the foregoing, where a Player has been suspended from bowling pursuant to either Articles 11.1 or 11.3 above, their National Cricket Federation may (but shall be under no obligation to) permit the Player to continue to bowl in their own domestic competitions.
- 11.6** Notwithstanding the recognition by the ICC of suspensions of Players under Article 11.3, only suspensions resulting from International Cricket shall be relevant for the purposes of Article 6.12 (automatic suspension for a minimum 1 year period resulting from a second suspension within a 2 year period).

12 DATABASE

- 12.1** The ICC shall be responsible for maintaining records in which the names of all Players reported under these Illegal Bowling Regulations and the details and status of all Independent Assessments, Expert Panel Analyses and Event Panel Analyses are recorded.
- 12.2** The ICC shall also maintain information on assessments conducted by National Cricket Federations and notified to the ICC pursuant to Article 10.3 of these Illegal Bowling Regulations.

13 AMENDMENT AND INTERPRETATION OF THE ILLEGAL BOWLING REGULATIONS

- 13.1** The Illegal Bowling Regulations may be amended from time to time by the Executive Board of the ICC, with such amendments coming into effect on the date specified by the ICC.
- 13.2** The headings used for the various Articles of these Illegal Bowling Regulations are for the purpose of guidance only and shall not be deemed to be part of the substance of these Illegal Bowling Regulations or to inform or affect in any way the language of the provisions to which they refer.
- 13.3** The Illegal Bowling Regulations shall come into full force and effect on 30 September 2018 (the "Effective Date"). They shall not apply retrospectively to Matches commencing prior to the Effective Date; provided, however, that any Match Officials' Report pending as of the Effective Date shall be governed by the predecessor version of these Illegal Bowling Regulations in force at the time of the alleged offence, subject to any application of the principle of *lex mitior*.
- 13.4** If any Article or provision of these Illegal Bowling Regulations is held invalid, unenforceable or illegal for any reason, these Illegal Bowling Regulations shall remain otherwise in full force apart from such Article or provision which shall be deemed deleted insofar as it is invalid, unenforceable or illegal.
- 13.5** These Illegal Bowling Regulations are governed by and shall be construed in accordance with English law. Strictly without prejudice to a Player's submission to the jurisdiction of a Judicial Commissioner under Article 11.2, disputes relating to these Illegal Bowling Regulations shall be subject to the exclusive jurisdiction of the English courts.

ANNEXURE 1

ICC STANDARDISED PROTOCOLS FOR THE ASSESSMENT OF SUSPECTED ILLEGAL BOWLING ACTIONS (THE “STANDARD ANALYSIS PROTOCOLS”)

Conduct of Independent Assessments

- 1 The ICC shall appoint an individual from the ICC Panel of Human Movement Specialists (the “**Appointed Specialist**”) to oversee the conduct of Independent Assessments in accordance with the Illegal Bowling Regulations.
- 2 All members of the ICC Panel of Human Movement Specialists shall have the necessary qualifications, equipment and access to Accredited Testing Centres in order to conduct Independent Assessments in accordance with these Standard Analysis Protocols.
- 3 As of the Effective Date, the ICC Panel of Human Movement Specialists consists of the following individuals:
 - Dr Mian Muhammad Awais;
 - Dr Andrea Cutti;
 - Mr. Gnanavel M.B.;
 - Mr. Sai Aditya;
 - Dr Luke Kelly;
 - Dr Mark King; and
 - Dr Helen Bayne.
- 4 Additional appropriately qualified human movement specialists may be appointed to the ICC Panel of Human Movement Specialists by the ICC from time to time.
- 5 Independent Assessments shall be conducted at Accredited Testing Centres by a Testing Team which shall be led by the Appointed Specialist.
- 6 As of the Effective Date, the Accredited Testing Centres comprise the following institutions:
 - Lahore University of Management Sciences, Lahore, Pakistan;
 - Loughborough University, Leicestershire, UK;
 - Sri Ramachandra University, Chennai, India;
 - The National Cricket Centre, Brisbane, Australia; and
 - The University of Pretoria, Hatfield, South Africa.
- 7 Additional appropriately equipped institutions may be accredited by the ICC as Accredited Testing Centres from time to time.

Equipment for Independent Assessments

- 8 Accredited Testing Centres shall be equipped with high speed video cameras, a 3D motion analysis system, a standardised kit of markers and calibration tools and any other facilities and equipment notified to the ICC by the ICC Panel of Human Movement Specialists from time to time.

- 9 The data collection and camera system shall be standardised by ICC-supplied calibration tools used in accordance with the instructions of the ICC Panel of Human Movement Specialists.
- 10 Standardised software packages provided by the ICC shall be used by the Testing Team to analyse the data from the Independent Assessment and produce the Independent Assessment Report.

Preparation for Independent Assessments

- 11 Prior to the Independent Assessment, the ICC shall provide the Appointed Specialist with video footage of the Player’s bowling action from the match in which the relevant Match Officials’ Report was submitted and/or other relevant video footage of the Player’s bowling action. This video footage shall be used by the Testing Team to compare the Player’s match bowling action with the Player’s bowling action during the Independent Assessment.
- 12 The Testing Team may, at the sole discretion of the Appointed Specialist, include a relevant cricketing expert (normally a first-class umpire, former player or specialist coach) to help the Testing Team to determine if the Player is accurately reproducing their match bowling action during the Independent Assessment.
- 13 Prior to the Independent Assessment the Testing Team shall provide the Player with an explanation of the requirements for the Independent Assessment under these Standard Analysis Protocols, including the deliveries that the Player shall be required to bowl in accordance with paragraphs 26-29.
- 14 The Testing Team, prior to the Independent Assessment, shall:
 - a) record the Player’s age, injury status, bowling arm and bowling style (Standard Delivery Type and any Specific Variations) on the Independent Assessment Report;
 - b) measure the Player’s height and weight and record this information on the Independent Assessment Report; and
 - c) assess the Player for joint hypermobility using the Beighton scale.
- 15 Prior to the Independent Assessment, the Testing Team shall give the Player the opportunity to present to the Appointed Specialist any medical and/or scientific information relevant to the Independent Assessment.
- 16 The Player may, at the cost of the Player and/or their National Cricket Federation, be accompanied to the Independent Assessment by an individual approved in advance by the ICC. Such person may include a chaperone, the Player’s coach or a member of the Player’s National Cricket Federation support staff. This individual shall be permitted to observe the Independent Assessment but cannot (unless invited by the Testing Team) be involved or interfere in any aspect of it.

Calibration and warm-up

- 17 Male Players shall undertake the Independent Assessment with a bare torso; female Players shall wear appropriate clothing as agreed with the Testing Team. The Testing Team may require shaving of some areas of the Player’s skin for the purpose of securely attaching the marker set.
- 18 The Testing Team shall:
 - a) place the marker set on the Player’s bowling arm and torso;
 - b) take photographs of the placement of the marker set; and
 - c) perform a series of shoulder and arm movements (system calibration) before and after the Player has bowled deliveries during their warm-up.

- 19 The process described in paragraph 18 above shall be repeated until the Testing Team is satisfied that the testing equipment is adequately calibrated.
- 20 The Testing Team shall provide the Player with the opportunity to conduct their normal pre-bowling warm-up routine, which shall comprise as many deliveries and shall be of such duration as the Player may require.
- 21 The Testing Team shall indicate clearly to the Player when the calibration process is complete and shall establish from the Player when their warm-up is complete and when the Player is ready to commence the Independent Assessment.

Procedure for Independent Assessments

- 22 The Independent Assessment shall be completed in one day.
- 23 Wherever possible, the Independent Assessment shall be conducted indoors on a full-length cricket pitch and with a full run-up available to the Player.
- 24 The Testing Team shall provide the ball to be used during the Independent Assessment, which may be new or used and shall be of the approved standard under the Standard Playing Conditions for Test, One Day International or Twenty20 International Cricket (in respect of male Players) or Women's Test Match Playing Conditions, ICC Women's Championship Playing Conditions or Women's Twenty20 Playing Conditions (in respect of female Players).
- 25 The Player shall be required to replicate their match bowling action (including full length run-up), position on the crease, and pace of delivery in bowling the mode and quantity of deliveries specified by the Testing Team in accordance with paragraphs 26-29 below (as applicable).
- 26 The Player shall be required to bowl a minimum of 18 and a maximum of 36 deliveries during the Independent Assessment. The Testing Team shall in their sole discretion determine the number of deliveries to be bowled using the Player's Standard Delivery Type and any Specific Variations.
- 27 A minimum of 6 deliveries of any mode of delivery that has been mentioned on a Match Officials' Report (Standard Delivery Type or Specific Variation) shall be required to be bowled by the Player during the Independent Assessment.
- 28 Where the Player's Standard Delivery Type is that of a fast/medium pace bowler, the deliveries to be bowled using their Standard Delivery Type shall, unless the Testing Team determines otherwise, be equally divided between deliveries of the following lengths (subject to a small margin of error at the Testing Team's discretion in accordance with paragraph 32(c)):
 - a) good length;
 - b) yorker length; and
 - c) bouncer length.
- 29 Where the Player's Standard Delivery Type is that of a spin bowler, the deliveries to be bowled using their Standard Delivery Type shall, unless the Testing Team determines otherwise, be good length deliveries (subject to a small margin of error at the Testing Team's discretion in accordance with paragraph 32(c)).

- 30 The Player shall, for the purposes of enabling the Testing Team to make the judgement required under paragraph 32(b) (wide delivery), verbally notify the Testing Team at the commencement of the Independent Assessment as to whether they wish their deliveries to be assessed as being delivered to a right or left-handed batsman. The Player may inform the Testing Team at any stage of the Independent Assessment if they wish to change this earlier notification. In the absence of any such notification, the Independent Assessment shall be conducted on the basis of a right-handed batsman.
- 31 The Player may at any time during the Independent Assessment request a break and/or refreshments, which the Testing Team shall accommodate wherever reasonable.
- 32 The Testing Team shall require the Player to repeat any of the following deliveries, which consequently shall not comprise part of the Independent Assessment:
 - a) any delivery which would be deemed a no ball under Law 24.5 (the feet) or Law 24.6 (breaking wicket in delivering ball) of the Laws of Cricket;
 - b) any delivery which would be deemed a wide under Law 25 of the Laws of Cricket; or
 - c) any delivery which, allowing for a small margin of error on the part of the Player in terms of length, does not correspond to the length of delivery specified by the Testing Team accordance with paragraph 28.
- 33 The Testing Team shall have complete discretion in judging (in respect of both the Player's Standard Delivery Type and all applicable Specific Variations):
 - a) whether the Player has accurately complied with the requirements of the Independent Assessment (including but not limited to the replication of their match bowling action, length of run-up, position on the crease, and pace of delivery); and
 - b) whether any deliveries are required to be repeated under paragraph 32 above in order for the Independent Assessment to be completed by the Player.

Independent Assessment Reports

- 34 The Independent Assessment Report shall be presented to the ICC (in the form prescribed by the ICC as set out at Appendix A) as soon as reasonably possible after the Independent Assessment and, unless exceptional circumstances exist, no later than 10 days from the date of the Independent Assessment.
- 35 The Independent Assessment Report shall also include:
 - a) a statement as to whether, in the opinion of the Appointed Specialist, the Player accurately replicated their match bowling action in the Independent Assessment (including in respect of any Specific Variations); and
 - b) a completed Player Attendance Form.

Validation

- 36 Immediately upon receipt of the Independent Assessment Report, the ICC shall send the Independent Assessment Report to at least one member of the ICC Panel of Human Movement Specialists (who shall not have had any prior involvement with the Player's case) for review and validation in accordance with Article 5.3 of the Illegal Bowling Regulations.

Determination

- 37 Article 2.1 of the Illegal Bowling Regulations references the degree of Elbow Extension that constitutes an Illegal Bowling Action. Where the validated Independent Assessment Report records the degree of Elbow Extension on any delivery of the Player’s Standard Delivery Type to be in excess of the level specified in Article 2.1, the Player shall therefore be determined to have used an Illegal Bowling Action. Where the validated Independent Assessment Report records the degree of Elbow Extension on any delivery of a Specific Variation to be in excess of the level specified in Article 2.1, the Player shall therefore be determined to have used an Illegal Bowling Action in respect of that Specific Variation.
- 38 Accordingly, in order for a Player to be determined to have used a legal bowling action (in respect of both their Standard Delivery Type and any applicable Specific Variations), the degree of Elbow Extension recorded for every delivery from each mode of delivery during the Independent Assessment must be within the level specified in Article 2.1 of the Illegal Bowling Regulations.

APPENDIX 1

INDEPENDENT ASSESSMENT REPORT TEMPLATE

SECTION 1 – MATCH OFFICIALS’ REPORT

Player Name:	
National Cricket Federation:	
Date of Match:	
Match covered by Match Officials’ Report: (Location, opposition and series/tournament)	
Standard Delivery Type:	
Specific Variations (if any): (include all relevant information on such variation deliveries)	
Any other relevant information:	

SECTION 2 – INFORMATION PROVIDED BY ICC

2.1 Video Footage

	Side-on (yes/no)	Behind (yes/no)	Front-on (yes/no)	Other (specify)	Fastest delivery speed (TV broadcast data)
Video footage available of Player bowling in match covered by Match Officials’ Report?					
Video footage available of Player bowling in a match other than that covered by the Match Officials’ Report? (provide details of match)					
Other Match (Date, opposition and series/tournament)					

SECTION 3 – INDEPENDENT ASSESSMENT

3.1 Details

Player Name:	
Date of Independent Assessment:	
Accredited Testing Centre:	
Appointed Specialist:	
Members of Testing Team:	[list all names]
Other individuals in attendance:	[list all names and reason for attendance]

3.2 Player Information

Date of birth:	
Current age:	
Height (cm):	
Weight (kg):	
Any current upper limb or other injury that would preclude the Player from using the bowling action used in match conditions:	Yes/ No [If 'yes', please describe]
Any other relevant anthropometric information:	
Bowling side upper limb injury history and/or anatomical abnormalities:	Shoulder Girdle: Shoulder Joint: Arm: Elbow: Forearm: Wrist: Hand:

Hypermobility Characteristic:	Left	Right
5th MCP joint extension past 90°		
Thumb to touch to forearm		
Elbow hyperextension past 10°		
Knee hyperextension past 10°		
Palms to floor (straight legs)		
Beighton Hypermobility Scale Score:	[X/9]	

3.3 Accredited Testing Centre Information

Assessment Set-Up:	See Figure 3
Motion Capture System:	[Insert details of the motion capture system specification; 2D and 3D]
High Speed Camera information:	[Insert details of position of the high-speed 2D cameras; method of synchronisation]
Any other relevant information regarding equipment used by the Assessment Team:	

3.4 Preparation for Independent Assessment

Cluster sizes	Acromion (ACR)	[small/medium/large/custom]
	Humerus Proximal (HP)	[small/medium/large/custom]
	Humerus Distal (HD)	[small/medium/large/custom]
	Forearm	[small/medium/large/custom]
Marker placement on bowling arm	See Figure 4	
Player warm-up	[e.g. Following calibration, the Player undertook their own pre-bowling warm-up routine including approximately X warm-up deliveries]	

3.5 Conduct of Independent Assessment

Number of deliveries of Player's Standard Delivery Type bowled during Independent Assessment:	
Number of deliveries of Player's Specific Variations (specify each such applicable Specific Variation by name):	
Number of discarded deliveries during Independent Assessment and, where applicable, reason for discarding and steps taken to address: (e.g. marker falling off; equipment failure; lack of replication of Match bowling action)	
Any other relevant information regarding the conduct of the Independent Assessment:	

SECTION 4 – RESULTS

4.1 Results of Independent Assessment

The degree of Elbow Extension used by the Player in delivering the ball during the Independent Assessment and measured using the Standard Analysis Protocols is set out at Table 1.

Still images comparing the Player’s Match bowling action with that used in the Independent Assessment are set out in Figure 2.

Graphs showing the degree of elbow flexion from upper-arm-horizontal (0%) to ball release (100%) for certain deliveries during the Independent Assessment are set out in Figure 1.

The Testing Team [were/were not] satisfied that the Player replicated their match bowling action (including full length run-up, position on the crease, and pace of delivery) during the Independent Assessment.

The Player’s Elbow Extension for their [Standard Delivery Type/Specific Variation Delivery (specify)] [did not exceed 15 degrees/exceeded 15 degrees] as set out in the Illegal Bowling Regulations.

Signature:

Name:.....

Role: Appointed Specialist

Date:

4.2 Validation

This Independent Assessment Report is deemed valid following a review of all relevant data and information as provided by the Appointed Specialist. The review indicated that the Independent Assessment was carried out correctly using the Standard Analysis Protocols under the Illegal Bowling Regulations.

Signature:

Name:.....

Role: Member of ICC Panel of Human Movement Specialists

Date:

SECTION 5 – ADDITIONAL SUPPORTING INFORMATION

Table 1 – Presentation of Results

Ball	Mode of delivery Standard Delivery Type or Specific Variation (specify)	Length of delivery Good Yorker Bouncer (specify)	Elbow Flexion Angle (Degrees)				Elbow Extension
			Upper Arm Horizontal	Maximum	Minimum	Ball Release	
1							
2							
3							
n							
Av.							

Commentary:

FIGURES

Figure 1: Graphs showing Elbow Extension (from upper-arm-horizontal (0%) to ball release (100%) for certain deliveries)

Figure 2: Comparison of Match bowling action against the bowling action used in the Independent Assessment

[insert comparative still images – multiple figures can be used to show comparison from various camera angles]

Figure 3: Accredited Testing Centre and camera set-up

Figure 4: Marker placement on bowling arm

CLOTHING AND EQUIPMENT RULES AND REGULATIONS

CLOTHING AND EQUIPMENT RULES AND REGULATIONS

A PREFACE

- 1 The objectives which ICC seeks to achieve through these Regulations are:
 - a) To ensure a consistent approach and to treat all Member Boards equally;
 - b) To ensure professional and appropriate standards of appearance of players and team officials;
 - c) To protect the sponsorship rights of ICC and its Member Boards (including from ambush marketing);
 - d) To allow an opportunity for players to obtain some revenue from controlled bat advertising;
 - e) To prohibit advertising connected with betting and/or gaming.
- 2 These Regulations are effective as from August 2019 and should be read in conjunction with Appendix 1, which sets out in diagrammatic form what marks and logos are permitted in what size and positions on particular items of cricket clothing and equipment in all formats of the game, and Appendix 2, which sets out the disciplinary process for breaches of these Regulations.

B DEFINITIONS

- 1 **Betting Logo** – a Logo which is either perceived, or likely to be perceived, by spectators and viewers, as being associated or connected in some way with betting, gaming or gambling of any kind.
- 2 **Charity Logo** – an ICC Approved Logo of an officially registered charity of a Member Board's choice.
- 3 **Commercial Logo** – an ICC Approved Logo of an entity which is the sponsor of a series, event, team or player.
- 4 **Cricket Clothing** – shirts, T-shirts, skins, trousers, sweaters, caps, hats, helmets, wristbands, headbands, sunglasses or other headgear.
- 5 **Cricket Equipment** – stumps, bats, pads, boots, shoes, gloves (batting or wicket-keeping), thigh pads, arm guards and other visible protective equipment.
- 6 **Event Logo** – an ICC Approved Logo of an international cricket event, which may include (but not consist solely of) a Commercial Logo of the sponsors of the event.
- 7 **Excluded Events** – unless otherwise advised by ICC, in advance of an event, Excluded Event means: ICC Cricket World Cup, ICC Under 19 Cricket World Cup, ICC Cricket World Cup Qualifier (or replacements for any of the same), ICC World Twenty/20, ICC World Twenty/20 Qualifier, ICC Women's World Cup and the ICC Women's World Twenty/20.
- 8 **ICC Approved** – in relation to any Logo, means approved by ICC (or by ICC Development (International) Limited ('IDI') as ICC may decide) in accordance with the procedure set out in Section L below, as qualifying as a Manufacturer's Logo, a Commercial Logo, an Event Logo, a National Logo or a Player's Bat Logo (as the case may be) and as not being a Betting Logo and as being otherwise in accordance with these Regulations.

- 9 **ICC's Chief Executive Officer** – means the person appointed by the ICC from time to time to act as the ICC's Chief Executive (or his/her designee).
- 10 **ICC's Cricket Operations Department** – means the department within the ICC designated as such and which is comprised of, amongst others, the ICC's General Manager – Cricket and the ICC's Senior Cricket Operations Manager.
- 11 **ICC Events** – means each of the following: (a) the ICC Cricket World Cup; (b) the ICC World Twenty20; (c) the ICC World Cricket League Championship and World Cricket League Division 2; (d) the ICC Women's Cricket World Cup; (e) the ICC Under 19 Cricket World Cup; (f) the ICC Cricket World Cup Qualifying Tournament; (g) the ICC Women's Cricket World Cup Qualifying Tournament; (h) the ICC World Twenty20 Qualifying Tournament; (i) the ICC Under 19 Cricket World Cup Qualifying Tournament; (j) the ICC Intercontinental Cup; (k) any match or event organised or sanctioned by the ICC from time to time which is televised and/or streamed live on the Internet; and (l) any match or event organised or sanctioned by the ICC from time to time which the ICC deems it appropriate that these Regulations should apply.
- 12 **ICC's General Counsel** – means the person appointed by the ICC from time to time to act as the ICC's General Counsel (or his/her designee).
- 13 **ICC's General Manager – Cricket** – means the person appointed by the ICC from time to time to act as the ICC's General Manager – Cricket (or his/her designee).
- 14 **ICC's Senior Cricket Operations Manager** – means the person appointed by the ICC from time to time to act as the ICC's Senior Cricket Operations Manager (or his/her designee).
- 15 **International Match** – means each of the following (in men's and women's cricket): (a) any Test Match, One Day International Match or Twenty20 International Match; (b) any match played as part of an ICC Event; (c) any International Tour Match; or (d) any other Match organised or sanctioned by the ICC from time to time to which the ICC deems it appropriate that these Regulations should apply.
- 16 **International Tour Match** – means any match played between a representative team of a Full Member (or an Associate or Affiliate Member with ODI or T20I status) and any domestic, guest or invitational team.
- 17 **Logo** – means any form of identification or branding including (without limitation) any corporate name, business name, internet domain name, title, flag, emblem, crest, mascot or trade mark (whether registered or not and including any symbol, device or colour(s) which functions or is intended to function as a trade mark).
- 18 **Manufacturer** – in relation to any item of Cricket Clothing or Cricket Equipment, 'Manufacturer' shall mean any entity carrying on the business of both:
- manufacturing or procuring the manufacture of the Cricket Equipment or the Cricket Clothing of the type in question; and
 - supplying it from readily available stock for sale throughout outlets of several kinds to members of the public in a country which is a Member of ICC, with the aid of published price lists and catalogues, and with profit directly from the sale of such Cricket Clothing or Cricket Equipment as its main aim.

An entity not otherwise within this definition shall not qualify as a Manufacturer by reason of its being associated in business with, or a company in the same group of companies as a Manufacturer.

No entity shall qualify as a Manufacturer of any item of Cricket Clothing or Cricket Equipment by virtue of its involvement in the manufacture of Cricket Clothing or Cricket Equipment of any other type. In particular (but without prejudice to the generality of the foregoing), no entity shall qualify as a Manufacturer of bats by reason of its manufacture of any other item of Cricket Equipment or Cricket Clothing.

An entity which as of October 2001 qualified as a 'Manufacturer' under the previous edition of these Regulations but which would not otherwise qualify as a Manufacturer hereunder shall be deemed to continue to qualify as a Manufacturer provided the Logo of any such entity shall not thereby qualify as a Manufacturer's Logo if it is a Betting Logo.

- 19 **Manufacturer's Logo** – an ICC Approved Logo of the Manufacturer of the item of Cricket Equipment or Cricket Clothing in question excluding, however:
- any Logo which (notwithstanding some connection with a Manufacturer) is also (either at the time of its adoption or subsequently) a Logo of, confusingly similar to or which suggests a connection with any entity which is not a Manufacturer; and
 - any Betting Logo.
- provided, however, that ICC may (in its sole discretion) approve as a Manufacturer's Logo, a Logo of an entity which, although not already a Manufacturer, is nevertheless a manufacturer of sports clothing and/or sports equipment other than Cricket Clothing and Cricket Equipment.
- For the purpose of these Regulations (including Appendices 1 and 2), all Manufacturer's Logos shall fall into one of the following five categories:
- Design Feature** – means any design feature of a Manufacturer which is distinctive to that Manufacturer and is used for the purposes of brand identification and/or cosmetic appeal but which does not contain any Manufacturer's Identification.
 - Identification Strip** – a tone on tone or contrasting strip containing a Manufacturer's Identification once or repeatedly.
 - Manufacturer's Identification** – means any express form of Manufacturer identification, including but not limited to a Manufacturer's name, model name, internet domain name, emblem, logo and/or trademark, but shall not include any Design Feature.
 - Official Product** – means the label which identifies an item as an official product of the Manufacturer.
 - Quality Feature** – means the label of the Manufacturer which promotes a quality feature used by the Manufacturer.
- 20 **National Logo** – an ICC Approved Logo of a country or its ICC Member Board.
- 21 **Non-Commercial Logo** – an ICC Approved Personal Message, visible tattoo or other Logo, which is not a Manufacturer's Logo, Commercial Logo, Player's Bat Logo, Betting Logo, Event Logo, Charity Logo or National Logo.

- 22 **Official ICC Apparel Supplier** – means a supplier of apparel contracted by ICC or IDI, from time to time, to supply apparel to the ICC, IDI and the ICC umpires and referees.
- 23 **Personal Message** – has the meaning ascribed to it in clause G1 below.
- 24 **Player's Bat Logo** – means an ICC Approved Logo of a sponsor of a player to be carried on the player's bat; provided that such Logo shall not be either:
- of, or confusingly similar to, or likely to be perceived as suggesting a connection with:
 - an entity which conflicts (whether through being a competitor or otherwise) with the exclusivity of any sponsor, supplier, or commercial partner of the Member Board of the player concerned or of an ICC Event; or
 - a Manufacturer, other than the Manufacturer of the item of cricket equipment it is to be carried on; or
 - a Betting Logo.

ICC shall have the final say in determining whether any such conflict or circumstances exist and no player may pursue any action against ICC or IDI, or against his team's ICC Member Board should he be precluded from displaying a Player's Bat Logo by reason of the same.

C SCOPE OF APPLICATION

- These Regulations shall apply to all International Matches. Contractual agreements (for example Member Participation Agreements and Player Squad Terms) and regulations pertaining specifically to individual ICC Events should also be consulted regarding specific instructions concerning clothing and equipment at such ICC Events. Where any conflict arises between these Regulations and the obligations contained in any specific ICC Event agreement and/or regulation, then the ICC Event specific agreement and/or regulations shall prevail.

NOTE: One example of where the regulations governing ICC Events differ from these Regulations is that Player's Bat Logos and Charity Logos shall not be permitted in Excluded Events. Accordingly, all players, agents, sponsors and manufacturers should ensure that they obtain a copy of any applicable agreements and/or regulations before finalising any arrangements that relate to the commercialisation of relevant cricket clothing and equipment during or in relation to any ICC Event.

- These Regulations govern the authorisation of clothing and equipment worn and used by players and team officials of Member Board representative teams. Sponsor advertising, manufacturer identification and the decorative rights of the Member Boards are also addressed.
- The aforesaid persons are subject to these provisions when on official duty for the aforesaid matches, either on the field of play or as otherwise expressly stated.
- These Regulations also cover sponsor advertising and manufacturer identification on stumps.

D GENERAL PROHIBITIONS

- Any clothing or equipment that does not comply with these Regulations is strictly prohibited. In particular, no Logo shall be permitted to be displayed on Cricket Clothing or Cricket Equipment, other than a National Logo, a Commercial Logo, an Event Logo, a Manufacturer's Logo, a Player's Bat Logo, a Charity Logo or a Non-Commercial Logo as provided in these Regulations. In addition, where any Match Official becomes aware of any clothing or equipment that does not comply with these Regulations, he shall be authorised to prevent the offending person from taking the field of play (or to order them from the field of play, if appropriate) until the non-compliant clothing or equipment is removed or appropriately covered up.
- It shall also be prohibited under these Regulations for any individual to wear any clothing or use any equipment that has been changed, altered or transformed (whether to comply with these Regulations or otherwise) in any way that, in the opinion of any Match Official, undermines the professional standards that are required of all elite players. For example, and without limitation, it shall be prohibited to cover up or alter the appearance of clothing and equipment with sticking plaster or marker pens and/or to wear batting pads painted with a coloured paint that has faded or is flaking off.
- For the avoidance of doubt, there shall be no requirement that a Match Official must first provide a warning to the offending individual to remove or cover up a prohibited logo before a breach of these Regulations can be established.

E CONTRASTING COLOURED KIT FOR HOME AND AWAY MATCHES

- For teams participating in a televised bi-lateral ODI or T20I, it is necessary to be able to distinguish between the teams on the field of play. Teams are therefore required to wear contrasting coloured kit.
- To be determined in advance of a series, the home team has preference in the choice of colour. The participating teams should agree in the respective MOU the colour of the kit the visiting team will wear if there is a clash of colour.
- For televised ICC events all participating teams will be required to provide for two different coloured kits, except for the host country who has preference in the choice of colour and may, if it chooses to do so, provide only one coloured kit to be worn in all matches throughout the event. In advance of the event the teams will be notified which coloured kit will be worn in each match.

F LOGOS – GENERAL PRINCIPLES

- In the case of the host team, the Commercial Logos may consist of the Event Logo and/or the Logos of up to three event, series or team sponsors. In the case of the visiting team the Commercial Logos may consist of the Logos of up to three team sponsors. For the avoidance of any doubt, no more than three sponsor names may be included in any Commercial Logo.
- Subject to the limitations contained in these Regulations a visiting team may display any Commercial Logo on its clothing or equipment irrespective of whether such Logos may conflict with any sponsor or supplier of the host Member Board.

- 3 The host Member Board shall not require a visiting team to wear the Event Logo without the consent of the Board of the visiting team. There shall be no obligation to give such consent, but if it is given, the visiting team must forego the use by its team sponsors of one of the two Commercial Logos.
- 4 Any Commercial Logo on clothing shall be decided by each Member Board and shall be common to and worn by each member of the team concerned. No individual Commercial Logos shall be worn by any team member, save for the carrying of a Player's Bat Logo on bats, as provided herein.
- 5 The National Logo, name of the country or national flag should not contain any advertising and must not interfere with any elements of the clothing identifying the player.
- 6 A visiting team shall abide by any law of the host country which restricts advertising of a product. No compensation shall be payable should a visiting team be precluded from displaying its Commercial Logos on Cricket Clothing or Cricket Equipment, and a visiting team shall not pursue any action against the host Member Board.
- 7 Only one Manufacturer may be identified on each article of cricket clothing and cricket equipment.
- 8 When required to be carried by a Manufacturer, any statutory wording is to be placed on the back of a player's bat and to be of discreet design only (subject to relevant statutory provisions).

G PERSONAL MESSAGES

- 1 Players and team officials shall not be permitted to wear, display or otherwise convey personal messages on their clothing, equipment or otherwise, irrespective of whether such messages are affixed to clothing, equipment or otherwise and whether such messages are displayed or conveyed through the use of the specific clothing or other items (e.g. an arm band) or by the use of words, symbol, graphic message, images or otherwise ("**Personal Messages**"), unless approved in advance by both the player or team official's Board and the ICC Cricket Operations Department. Approval shall not be granted for messages which relate to political, religious or racial activities or causes. The ICC shall have the final say in determining whether any such message is approved. For the avoidance of doubt, where a message is approved by the player or team official's Board but subsequently disapproved by the ICC's Cricket Operations Department, the player or team official shall not be permitted to wear, display or otherwise convey such message in International Matches.

GUIDANCE NOTE: In determining whether a message is for a "political, religious or racial cause", the starting point is that the ICC and its Members acknowledge and agree that cricket should be used as a tool to bring people and communities around the world together and not as a platform to draw attention to potentially divisive political issues, rhetoric or agendas. Each case must be considered on its own facts and the ICC will take into account all relevant circumstances, including (as it sees fit): (a) the views of any other relevant team or individual; (b) the likely sentiment and response in the media to the message in all relevant countries; (c) whether the message is a 'one-off' or whether it is to be displayed for a longer period; (d) the purpose and impact of conveying the message. By way of example only, and without limitation, where the purpose of a message appears to be commemorative in nature (e.g. the use of a black armband or a poppy) or to serve a charitable purpose (e.g. to generate funds or awareness for a non-political charitable cause), it is more likely to be permitted; where a message appears to indicate support for a particular government, political party or individual, it is more likely to be prohibited. Where a request for approval is submitted to the ICC, the ICC shall be entitled to request such further information as it considers necessary before making its decision and to impose such conditions as it sees fit in providing its approval (as applicable).

- 2 Visible Tattoos (permanent or temporary) incorporating any Commercial or Manufacturer's Logo shall not be permitted.

H TRAINING CLOTHING

- 1 Team Training Bibs: Shall be of a distinguishing colour to that of the playing shirts.
- 2 Only training kit (which shall include tracksuits, sweatshirts, branded T-shirts, team training bibs etc.) issued to the team by its Board (hereinafter referred to as team training kit) may be worn by the players and team officials within the precincts of the ground on match days as well as at all official team practice and training sessions.
- 3 Save for the requirement in the relevant playing conditions that squad members of the fielding team who are not playing in the match and who are not acting as substitute fielders shall be required to wear a team training bib whilst on the playing area (including the area between the boundary and the perimeter fencing). No training kit is to be worn by players on the field during the hours of play.
- 4 Subject to the provisions of paragraphs F1, F6 and H1, and the proviso that the team training kit is uniform to all members of the same team, and other than in the case of Excluded Events, there shall be no restriction on the colour or design of the team training kit nor on the number, positioning and size of the National, Commercial or Manufacturer's Logos thereon.

I TOSS

Players attending at the toss will be expected to be in team playing clothing. Team blazers shall be optional.

**J PRESS CONFERENCES, POST- MATCH PRESENTATIONS
AND TELEVISION INTERVIEWS**

Players or team officials attending post match presentation ceremonies and press conferences as well as television interviews conducted during or after the match shall be expected to be in either team playing clothing, team training kit excluding vests and shorts or other appropriate team clothing.

K MEASUREMENT METHOD

Items will be measured according to their geometric shape. To calculate the surface area, items may be divided into several geometric forms. Non standard shapes will be measured as rectangles.

L ICC APPROVAL

- 1 In order for any Logo or Personal Message to be ICC Approved for use in any match or series of matches to which these Regulations apply, the party seeking approval (e.g. the entity claiming to be the Manufacturer in the case of approval sought for a Manufacturer's Logo) must apply to ICC for the grant of such approval as set out in clause 2 below and such approval must have been granted in advance of the commencement of the match or series in question. Once a Logo or Personal Message has been ICC Approved for any relevant match or series of matches, such approval shall remain effective for all other applicable matches and series thereafter until either:
 - a) such time as these Regulations may be amended or replaced in any way affecting the continuing compliance of such Logo or Personal Message in which case the Logo or Personal Message shall cease to be approved immediately unless the Logo or Personal Message is being used in a match or series at the time of ICC giving notice of the amendment or replacement of the Regulations or is due to be used in such a match or series within 30 days after such notice in which case such approval will cease to apply to the Logo or Personal Message concerned at the end of the match or series in question; or
 - b) until ICC gives notice that the Logo or Personal Message is no longer ICC Approved due to it ceasing to be in compliance with these Regulations from time to time (e.g. that since the original grant of ICC Approval, the Logo has become a Betting Logo) in which case the Logo or Personal Message will cease to be ICC approved immediately upon ICC giving notice to that effect.
- 2 Any application to ICC for a Logo or Personal Message to be ICC Approved shall be sent to ICC at Dubai Sports City, PO Box 500070, Dubai, marked 'Cricket Operations Department'. The application shall state the type of Logo for which the approval is sought (e.g. whether a Manufacturer's Logo, a Player's Bat Logo, etc.) or shall set out the wording of the proposed Personal Message and shall include a sample of the Logo or Personal Message for the item of Cricket Clothing or Cricket Equipment to which it is proposed (subject to approval being granted) to be applied. In respect of any Logo which is required by these Regulations to be within certain size parameters, the applicant must state the size which it considers such Logo to be and provide evidence of how this has been calculated. ICC retains the final say in determining whether any Logo is within the permitted parameters.

- 3 ICC will review any application for a Logo or Personal Message to be ICC Approved which has been received in accordance with clause 2 above and within 3 days of receipt of such application (counting from the first business day on which, or following which, the application was received and discounting any intervening days which are not regular business days – e.g. weekends and public holidays) shall respond to the applicant, acknowledging receipt of the application and, if applicable, confirming that ICC has been provided with the required information and materials or, alternatively, stating that ICC considers that it has not been provided with all requisite details/materials as set out in clause 2 above and requesting that the applicant provides the same.
- 4 ICC shall use its best endeavours (but does not undertake) to provide its final determination to the applicant for a Logo or Personal Message to be ICC Approved within 10 business days of its having confirmed receipt of all requisite information and materials for such application.

M BREACH OF REGULATIONS BY PLAYERS AND BOARDS

In the event of a breach by any player, team official or Board of these Regulations, the disciplinary process and sanctions set out in Appendix 2 shall apply. For the avoidance of doubt, a Board may breach these Regulations in circumstances where it issues equipment or clothing to a player or team official which does not comply with the terms of these Regulations.

N BREACH OF REGULATIONS BY MANUFACTURERS

In the event that any Manufacturer, in the absolute discretion of the ICC, repeatedly breaches the terms of these Regulations, the ICC reserves the right to revoke any approval granted to such Manufacturer pursuant to paragraph K above upon written notice to the Manufacturer. Any such revocation of approval shall take effect from the date specified in the written notice.

APPENDIX 1

CLOTHING AND EQUIPMENT

TEST MATCHES

PLAYING SWEATER – LONG SLEEVED.....	19.12
PLAYING SHIRT – SLEEVELESS.....	19.14
PLAYING SHIRT.....	19.16
PLAYING TROUSERS.....	19.18
PLAYING CAP AND SUNHAT.....	19.20

ONE DAY INTERNATIONALS

PLAYING SWEATER – LONG SLEEVED.....	19.22
PLAYING SHIRT – SLEEVELESS.....	19.24
PLAYING SHIRT.....	19.26
PLAYING TROUSERS.....	19.28
PLAYING CAP AND SUNHAT.....	19.30

T20 INTERNATIONALS

PLAYING SWEATER – LONG SLEEVED.....	19.32
PLAYING SHIRT – SLEEVELESS.....	19.34
PLAYING SHIRT.....	19.36
PLAYING TROUSERS.....	19.38
PLAYING CAP AND SUNHAT.....	19.40

OTHER CLOTHING

TEAM TRAINING BIB.....	19.42
T-SHIRTS.....	19.43
SKINS.....	19.44
SOCKS.....	19.45
TURBANS, BANDANAS AND HIJABS.....	19.46
HEADBANDS AND WRISTBANDS.....	19.47

CRICKET EQUIPMENT

CRICKET BAT.....	19.48
WICKET KEEPER GLOVES.....	19.49
BATTING GLOVES.....	19.50
HELMET.....	19.51
WICKET KEEPER PADS.....	19.52
BATTING PADS.....	19.53
SHOES AND BOOTS.....	19.54
SUN GLASSES.....	19.55
ARM GUARDS.....	19.56
FACE PROTECTOR.....	19.57
STUMPS.....	19.58
THIGH PADS, SHIN PROTECTORS AND OTHER EQUIPMENT.....	19.59

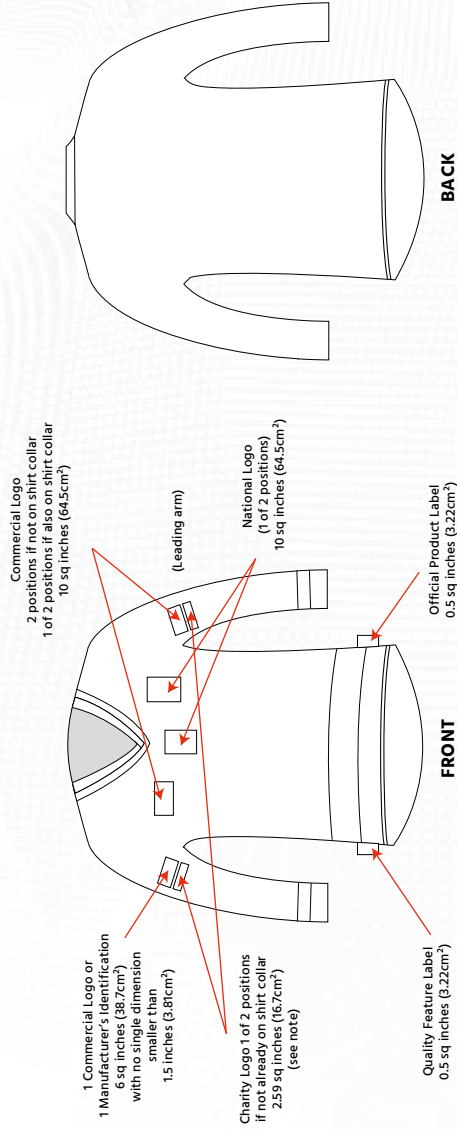

NOTE: Zips, poppers, buttons and Velcro are not permitted anywhere from the bottom up to the chest

NOTE

COLOUR AND DESIGN	NAME, NUMBER AND INITIALS	OTHER MARKS AND INSIGNIA
<ul style="list-style-type: none"> The colours and design of the sweaters (including Logos) shall be uniform to all members of the same team. Sweaters shall be plain white/cream, save that coloured piping or trim and stripes shall be permitted subject to the following restrictions: <ul style="list-style-type: none"> Piping is restricted to 0.5 cm (0.2 in) in width. Only one colour of piping/trim is permitted on any sweater. Piping is restricted to the sweater seams. Stripes in team colours are permitted around the waist, neck (traditional V shape) and wrist cuffs. 	<ul style="list-style-type: none"> One of the following numbers is permitted to be displayed on the long sleeved sweaters in a position immediately below the National Logo on the front of the sweater: <ul style="list-style-type: none"> Indicating a player's order of selection for his country, or Indicating the number of caps earned by a player for his country, or Indicating a player's landmark achievement (50, 100, 150 Tests etc.). Such numbers shall not be more than 2 cm (0.78 in) in height. A player's initials may be displayed on the chest or sleeve of the long sleeved sweater. Such initials shall not be more than 2 cm (0.78 in) in height. 	<ul style="list-style-type: none"> Players representing Member Boards who have won the ICC Test Play-off may display a symbol on the sweater for each of the occasions that this has been achieved. No restrictions on position. Each symbol shall not exceed 1 sq cm in size. The name of the opposing touring team or the name of the country being toured as well as the year of such tour may be displayed on the chest of the sweater immediately below the National Logo provided such numbers and letters shall not exceed 1 cm (0.4 in) in height. Charity ribbons/logos that are worn on team uniforms must be transferred on to the uniform. Stick on logos are also permitted. Ribbons/logos with pins are not permitted.

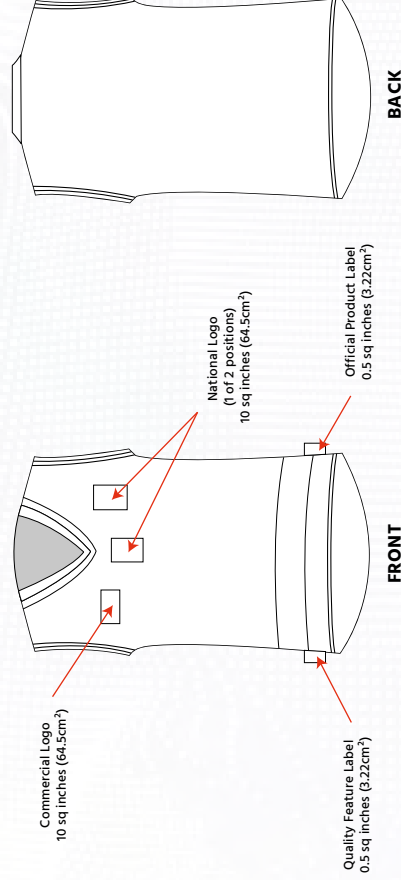

NOTE: Zips, poppers, buttons and Velcro are not permitted anywhere from the bottom up to the chest

NOTE

COLOUR AND DESIGN	NAME, NUMBER AND INITIALS	OTHER MARKS AND INSIGNIA
<ul style="list-style-type: none"> The colours and design of the sweaters (including Logos) shall be uniform to all members of the same team. Sweaters shall be plain white/cream, save that coloured piping or trim and stripes shall be permitted subject to the following restrictions: <ul style="list-style-type: none"> Piping is restricted to 0.5 cm (0.2 in) in width. Only one colour of piping/trim is permitted on any sweater. Piping is restricted to the sweater seams. Stripes in team colours are permitted around the waist and neck (traditional V shape). 	<ul style="list-style-type: none"> One of the following numbers is permitted to be displayed on the sleeveless sweaters in a position immediately below the National Logo on the front of the sweater: <ul style="list-style-type: none"> Indicating a player's order of selection for his country, or Indicating the number of caps earned by a player for his country, or Indicating a player's landmark achievement (50, 100, 150 Tests etc.). Such numbers shall not be more than 2 cm (0.78 in) in height. A player's initials may be displayed on the chest of the sleeveless sweater. Such initials shall not be more than 2 cm (0.78 in) in height. 	<ul style="list-style-type: none"> Players representing Member Boards who have won the ICC Test Play-off may display a symbol on the sweater for each of the occasions that this accomplishment has been achieved. No restrictions on position. Each symbol shall not exceed 1 sq cm in size. The name of the opposing touring team or the name of the country being toured as well as the year of such tour may be displayed on the chest of the sleeveless sweater immediately below the National Logo provided such numbers and letters shall not exceed 1 cm (0.4 in) in height.

TEST MATCHES PLAYING SHIRT

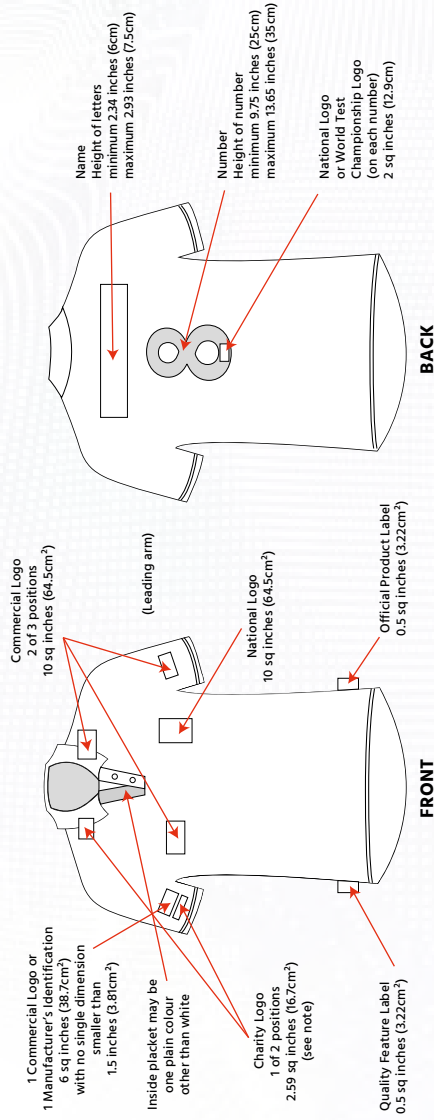

NOTE: Zips, poppers, buttons and Velcro are not permitted anywhere from the bottom up to the chest
NOTE: The World Test Championship Logo displayed in the number shall be white only

NOTE

COLOUR AND DESIGN	NAME, NUMBER AND INITIALS	OTHER MARKS AND INSIGNIA
<ul style="list-style-type: none"> The colours and design of the shirts (including Logos) shall be uniform to all members of the same team. Playing shirt sleeves may be cut to any length, as long as both sleeves are evenly trimmed and the edges are sewn and hemmed. Playing shirts shall be plain white/cream, save that coloured piping or trim shall be permitted subject to the following restrictions. <ul style="list-style-type: none"> Piping is restricted to 0.5 cm (0.2 in) in width. Only one colour of piping/trim is permitted on any shirt. Piping is restricted to the edge of the shirt collar, shirt seams and cuffs. The inside of the placket may be of a plain colour other than white. 	<ul style="list-style-type: none"> Effective from 1st August 2019, the names and numbers of players carried on the playing shirts shall correctly reflect the identity of the player. The number on the shirts shall be clearly legible, positioned in the centre back of the shirt. <ul style="list-style-type: none"> The range of permitted numbers is 1 – 99. The numbers shall be sewn on or fixed by heat transfer and not affixed by Velcro or any temporary means. The names must be positioned above the number on the back of the shirt and the letters used must be clearly legible. The names and numbers may not contain any advertising elements. One of the following numbers is permitted to be displayed on the playing shirts in a position immediately below the National Logo on the front of the shirt: <ul style="list-style-type: none"> Indicating a player's order of selection for his country, or Indicating the number of caps earned by a player for his country, or Indicating a player's landmark achievement (50, 100, 150 Tests etc.). Such numbers shall not be more than 2 cm (0.78 in) in height. A player's initials may be displayed on the chest or sleeve of the playing shirt. Such initials shall not be more than 2 cm (0.78 in) in height. 	<ul style="list-style-type: none"> Teams participating in the ICC World Test Championship may display the year the country played its first Test Match above the National Logo. Such numbers shall not exceed 1cm (0.4in). Teams participating in the ICC World Test Championship final may display the names of the competing teams and the date and venue of the final below the National Logo. Such letters and numbers shall not exceed 1 cm (0.4 in). The name of the opposing touring team or the name of the country being toured as well as the year of such tour may be displayed on the chest of the playing shirt immediately below the National Logo provided such numbers and letters shall not exceed 1 cm (0.4 in) in height. Charity ribbons/logos that are worn on team uniforms must be transferred on to the uniform. Stick on logos are also permitted. Ribbons/logos with pins are not permitted.

TEST MATCHES

PLAYING TROUSERS

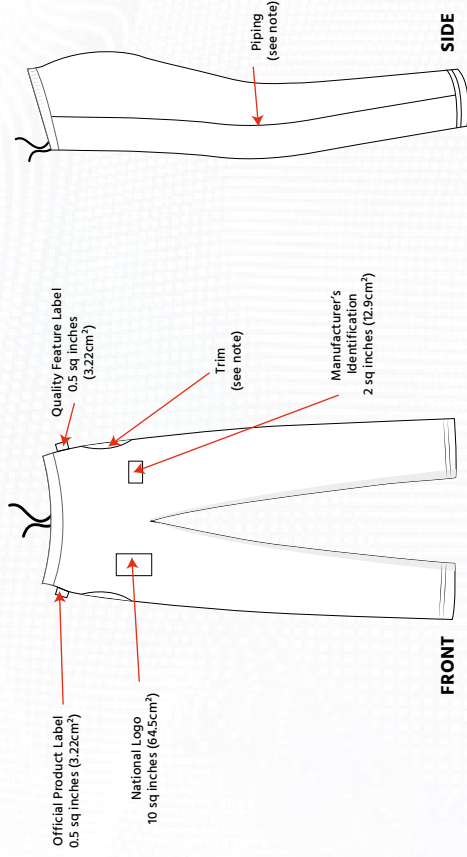

NOTE: Zips, poppers, buttons and Velcro are not permitted anywhere from the knee up to the waist

NOTE

COLOUR AND DESIGN	NAME, NUMBER AND INITIALS	OTHER MARKS AND INSIGNIA
<ul style="list-style-type: none"> Trousers shall be plain white/cream, save that coloured piping or trim shall be permitted subject to the following restrictions: <ul style="list-style-type: none"> Piping is restricted to 0.5 cm (0.2 in) in width. Piping is restricted to the edge of the pockets and the outside seam of the leg of the trousers. Only one colour of piping/trim is permitted and shall be the same colour as the piping/trim, if any, on the playing shirt. If coloured piping/trim is used, the colour and design of the trousers (including Logos) shall be uniform to all members of the same team. The inside of the pocket may be of a plain colour other than white/cream. 	<ul style="list-style-type: none"> None permitted. 	<ul style="list-style-type: none"> None permitted.

TEST MATCHES

PLAYING CAP AND SUN HAT

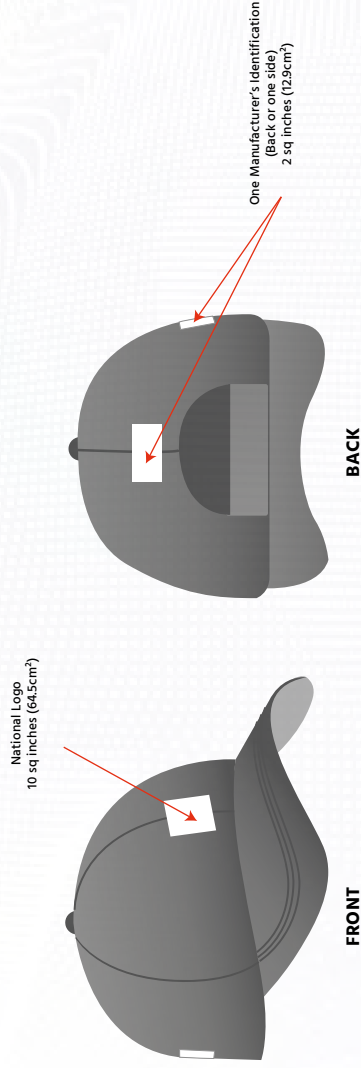

NOTE

COLOUR AND DESIGN	NAME, NUMBER AND INITIALS	OTHER MARKS AND INSIGNIA
<ul style="list-style-type: none"> • Colour – Caps and sunhats must be the same colour to all members of the same team. As an alternative, a white sunhat may be worn. • Design – The design of the cap and sunhat shall be uniform to all members of the same team. 	<ul style="list-style-type: none"> • One of the following numbers is permitted to be displayed on the caps and sunhats in a position immediately below the National Logo. <ul style="list-style-type: none"> • Indicating a player's order of selection for his country, or • Indicating the number of caps earned by a player for his country, or • Indicating a player's landmark achievement (50, 100, 150 Tests etc). • Such numbers shall not be more than 2 cm (0.78 in) in height. • A player's initials may be displayed on the back or side of the cap or sunhat. Such initials shall not be more than 2 cm (0.78 in) in height. 	<ul style="list-style-type: none"> • None permitted.

ONE DAY INTERNATIONALS

PLAYING SWEATER – LONG SLEEVED

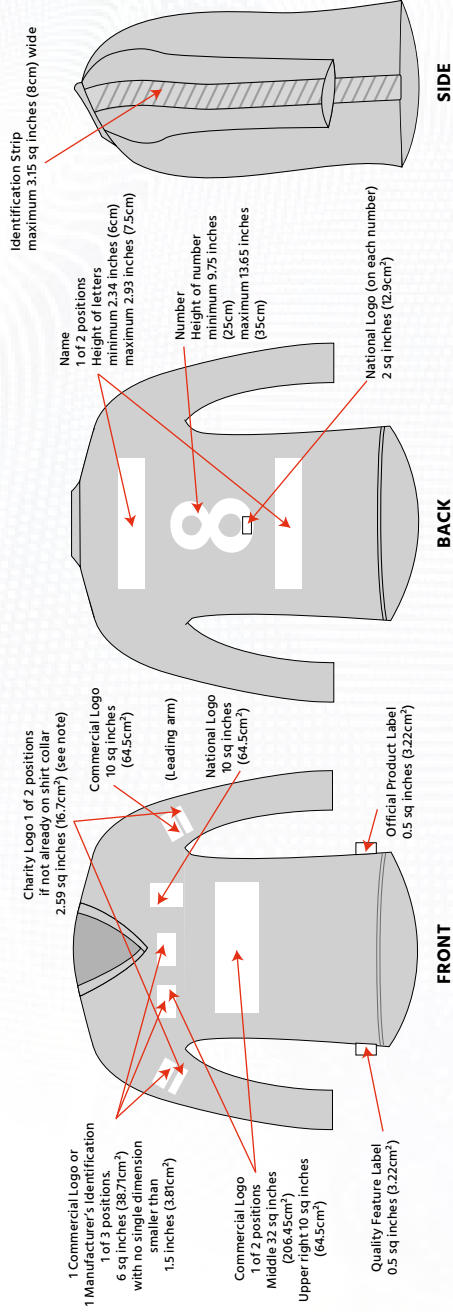

NOTE: Zips, poppers, buttons and Velcro are not permitted anywhere from the bottom up to the chest

NOTE

COLOUR AND DESIGN	NAME, NUMBER AND INITIALS	OTHER MARKS AND INSIGNIA
<ul style="list-style-type: none"> Each Member Board shall be entitled to choose the colours and design of its playing sweater subject to the following restrictions: <ul style="list-style-type: none"> The sweaters shall be coloured other than white, cream or any light colour which is likely to make the sighting of a white ball difficult, the decision of the ICC Senior Cricket Operations Manager being final. The colours and design of the playing sweaters (including Logos) shall be uniform to all members of the same team. Each Member Board shall be required to register the pantone colours of its playing clothing with the ICC prior to its use thereof. 	<ul style="list-style-type: none"> In the event of names and/or numbers of players being carried on the playing sweaters, they shall correctly reflect the identity of the player. The number on the sweaters shall be clearly legible and positioned in the centre back of the sweater. The numbers shall be sewn on or fixed by heat transfer and not affixed by Velcro or any temporary means. The names must be positioned above or below the number on the back of the sweater and the letters used must be clearly legible. The names and numbers may not contain any advertising elements. In addition, one of the following numbers is permitted to be displayed on the playing sweaters in a position immediately below the National Logo on the front of the sweater: <ul style="list-style-type: none"> Indicating a player's order of selection for his country, or Indicating the number of caps earned by a player for his country, or Indicating a player's landmark achievement (50, 100, 150 ODIs etc). Such numbers shall not be more than 2 cm (0.78 in) in height. A player's initials may be displayed on the chest or sleeve of the long sleeved sweater. Such initials shall not be more than 2 cm (0.78 in) in height. 	<ul style="list-style-type: none"> Nothing contained herein shall prevent the National Logo, the name of the country and/or the national flag or elements contained therein from being incorporated as part of the design of the playing sweaters. Players representing Member Boards who have won the ICC Cricket World Cup may display a symbol on the playing sweater for each of the occasions that this accomplishment has been achieved. No restrictions on position. Each symbol shall not exceed 1 sq cm in size. The name of the opposing touring team or the name of the country being toured as well as the year of such tour may be displayed on the chest of the playing sweater immediately below the National Logo provided such numbers and letters shall not exceed 1 cm (0.4 in) in height. Charity ribbons/logos that are worn on team uniforms must be transferred on to the uniform. Stick on logos are also permitted. Ribbons/logos with pins are not permitted.

ONE DAY INTERNATIONALS

PLAYING SWEATER – SLEEVELESS

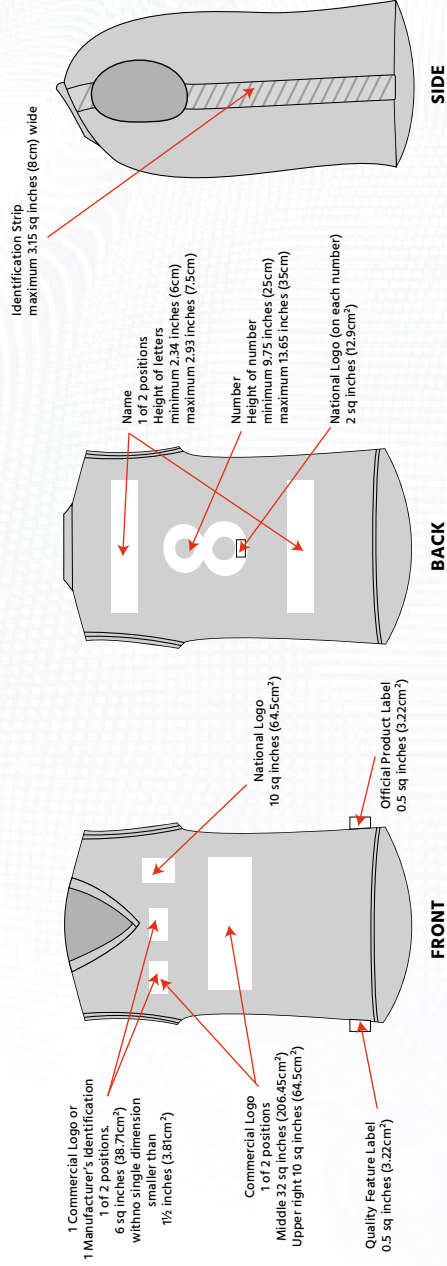

NOTE: Zips, poppers, buttons and Velcro are not permitted anywhere from the bottom up to the chest

NOTE

COLOUR AND DESIGN	NAME, NUMBER AND INITIALS	OTHER MARKS AND INSIGNIA
<ul style="list-style-type: none"> Each Member Board shall be entitled to choose the colours and design of its playing sweater subject to the following restrictions: <ul style="list-style-type: none"> The sweaters shall be coloured other than white, cream or any light colour which is likely to make the sighting of a white ball difficult, the decision of the ICC Senior Cricket Operations Manager being final. The colours and design of the playing sweaters (including Logos) shall be uniform to all members of the same team. Each Member Board shall be required to register the pantone colours of its playing clothing with the ICC prior to its use thereof. 	<ul style="list-style-type: none"> In the event of names and/or numbers of players being carried on the playing sweaters, they shall correctly reflect the identity of the player. The number on the sweaters shall be clearly legible, positioned in the centre back of the sweater. The numbers shall be sewn on or fixed by heat transfer and not affixed by Velcro or any temporary means. The names must be positioned above or below the number on the back of the sweater and the letters used must be clearly legible. The names and numbers may not contain any advertising elements. In addition, one of the following numbers is permitted to be displayed on the playing sweaters in a position immediately below the National Logo on the front of the sweater: <ul style="list-style-type: none"> Indicating a player's order of selection for his country, or Indicating the number of caps earned by a player for his country, or Indicating a player's landmark achievement (50, 100, 150 ODIs etc.). Such numbers shall not be more than 2 cm (0.78 in) in height. A player's initials may be displayed on the chest of the sleeveless sweater. Such initials shall not be more than 2 cm (0.78 in) in height. 	<ul style="list-style-type: none"> Nothing contained herein shall prevent the National Logo, the name of the country and/or the national flag or elements contained therein from being incorporated as part of the design of the playing sweaters. Players representing Member Boards who have won the ICC Cricket World Cup may display a symbol on the chest of the playing sweater for each of the occasions that this accomplishment has been achieved. No restrictions on position. Each symbol shall not exceed 1 sq cm in size. The name of the opposing touring team or the name of the country being toured as well as the year of such tour may be displayed on the chest of the playing sweater immediately below the National Logo provided such numbers and letters shall not exceed 1 cm (0.4 in) in height.

ONE DAY INTERNATIONALS PLAYING SHIRT

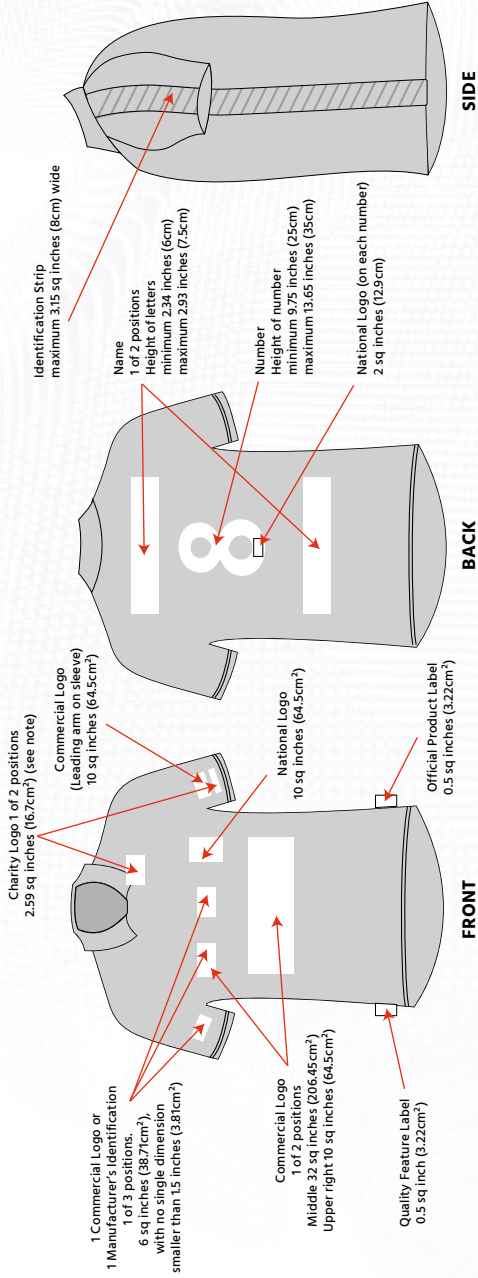

NOTE: Zips, poppers, buttons and Velcro are not permitted anywhere from the bottom up to the chest

NOTE

COLOUR AND DESIGN	NAME, NUMBER AND INITIALS	OTHER MARKS AND INSIGNIA
<ul style="list-style-type: none"> Each Member Board shall be entitled to choose the colours and design of its playing shirt subject to the following restrictions: <ul style="list-style-type: none"> The playing shirts shall be coloured other than white, cream or any light colour which is likely to make the sighting of a white ball difficult, the decision of the ICC Senior Cricket Operations Manager being final. The colours and design of the playing shirts (including Logos) shall be uniform to all members of the same team. Playing shirt sleeves may be cut to any length, as long as both sleeves are evenly trimmed and the edges are sewn and hemmed. Each Member Board shall be required to register the pantone colours of its playing clothing with the ICC prior to its use thereof. 	<ul style="list-style-type: none"> In the event of names and/or numbers of players being carried on the playing shirts, they shall correctly reflect the identity of the player. The number on the shirts shall be clearly legible, positioned in the centre back of the shirt. The numbers shall be sewn on or fixed by heat transfer and not affixed by Velcro or any temporary means. The names must be positioned above or below the number on the back of the shirt and the letters used must be clearly legible. The names and numbers may not contain any advertising elements. In addition, one of the following numbers is permitted to be displayed on the playing shirts in a position immediately below the National Logo on the front of the shirt: <ul style="list-style-type: none"> Indicating a player's order of selection for his country, or Indicating the number of caps earned by a player for his country, or Indicating a player's landmark achievement (50, 100, 150 ODIs etc). Such numbers shall not be more than 2 cm (0.78 in) in height. A player's initials may be displayed on the chest or sleeve of the playing shirt. Such initials shall not be more than 2 cm (0.78 in) in height. 	<ul style="list-style-type: none"> Nothing contained herein shall prevent the National Logo, the name of the country and/or the national flag or elements contained therein from being incorporated as part of the design of the playing shirts. Players representing Member Boards who have won the ICC Cricket World Cup may display a symbol on the chest of the playing shirt for each of the occasions that this accomplishment has been achieved. No restrictions on position. Each symbol shall not exceed 1 sq cm in size. The name of the opposing touring team or the name of the country being toured as well as the year of such tour may be displayed on the chest of the playing shirt immediately below the National Logo provided such numbers and letters shall not exceed 1 cm (0.4 in) in height. Charity ribbons/logos that are worn on team uniforms must be transferred on to the uniform. Stick on logos are also permitted. Ribbons/logos with pins are not permitted.

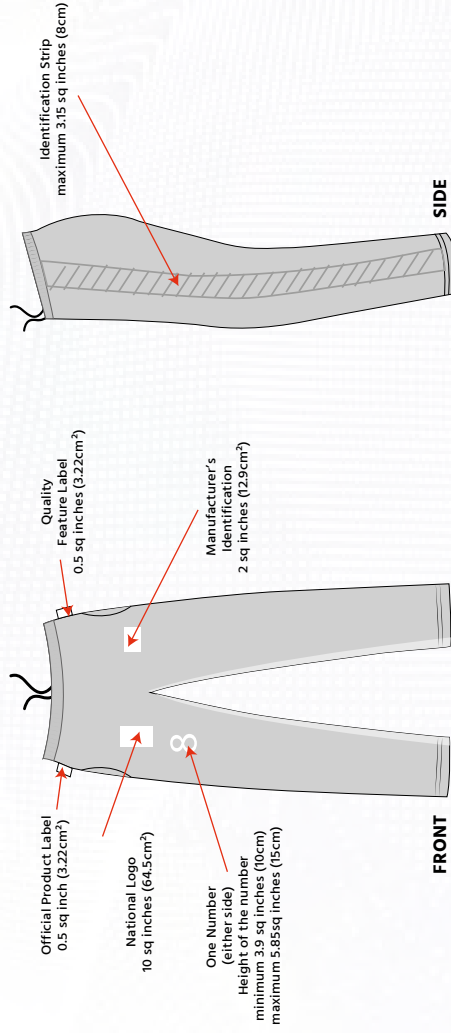

NOTE: Zips, poppers, buttons and Velcro are not permitted anywhere from the knee up to the waist

NOTE

COLOUR AND DESIGN	NAME, NUMBER AND INITIALS	OTHER MARKS AND INSIGNIA
<ul style="list-style-type: none"> Each Member Board shall be entitled to choose the colours and design of its playing trousers subject to the following restrictions: The playing trousers shall be coloured other than white, cream or any light colour which is likely to make the sighting of a white ball difficult, the decision of the ICC Senior Cricket Operations Manager being final. The colours and design of the playing trousers (including Logos) shall be uniform to all members of the same team. Each Member Board shall be required to register the pantone colours of its playing clothing with the ICC prior to its use thereof. 	<ul style="list-style-type: none"> In the event of numbers being carried on the trousers, they shall be clearly legible and positioned on the front of either leg above the knee. The numbers shall be sewn on or fixed by heat transfer and not affixed by Velcro or any temporary means. 	<ul style="list-style-type: none"> Nothing contained herein shall prevent the National Logo, the name of the country and/or the national flag or elements contained therein from being incorporated as part of the design of the playing trousers.

ONE DAY INTERNATIONALS

PLAYING CAP AND SUN HAT

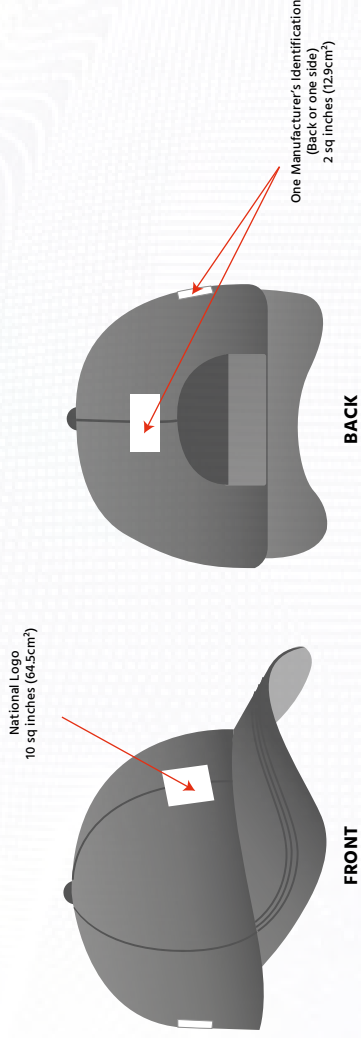

NOTE

COLOUR AND DESIGN	NAME, NUMBER AND INITIALS	OTHER MARKS AND INSIGNIA
<ul style="list-style-type: none"> Colour – Caps and sunhats must be the same colour to all members of the same team. As an alternative a white sunhat may be worn if a team issued coloured sunhat has not been provided. Design – The design of the cap and sunhat shall be uniform to all members of the same team. 	<ul style="list-style-type: none"> One of the following numbers is permitted to be displayed on the caps and sunhats in a position immediately below the National Logo or on one side: <ul style="list-style-type: none"> Indicating a player's order of selection for his country, or Indicating the number of caps earned by a player for his country, or Indicating a player's landmark achievement (50, 100, 150 ODIs etc). Such numbers shall not be more than 2 cm (0.78 in) in height. A player's initials may be displayed on the back or one side of the cap or sunhat. Such initials shall not be more than 2 cm (0.78 in) in height. 	<ul style="list-style-type: none"> None permitted.

T20 INTERNATIONALS PLAYING SWEATER – LONG SLEEVED

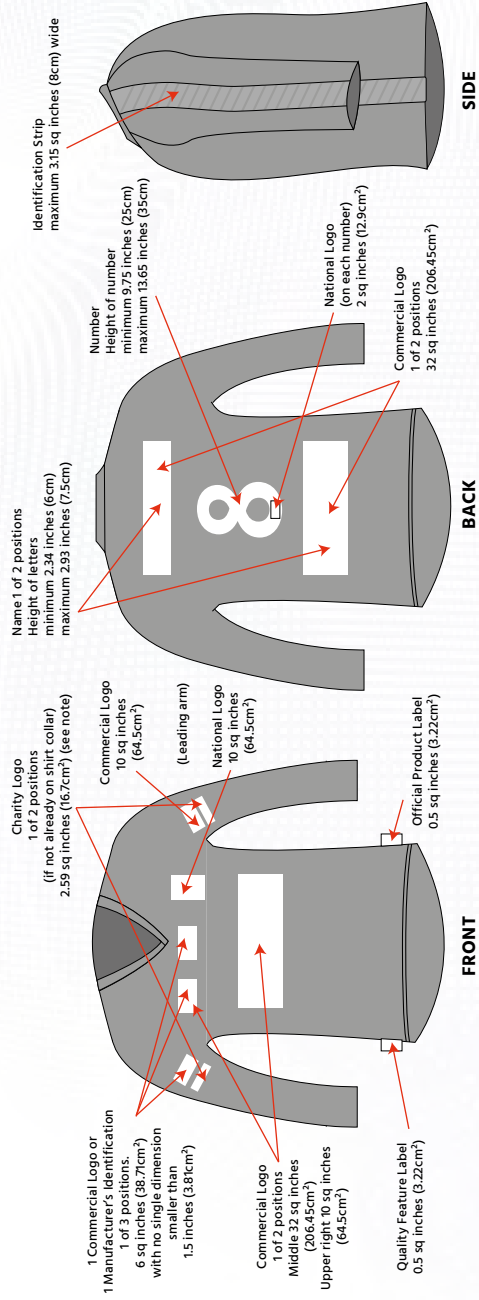

NOTE: Zips, poppers, buttons and Velcro are not permitted anywhere from the bottom up to the chest

NOTE

COLOUR AND DESIGN	NAME, NUMBER AND INITIALS	OTHER MARKS AND INSIGNIA
<ul style="list-style-type: none"> Each Member Board shall be entitled to choose the colours and design of its playing sweater subject to the following restrictions: <ul style="list-style-type: none"> The sweaters shall be coloured other than white, cream or any light colour which is likely to make the sighting of a white ball difficult, the decision of the ICC Senior Cricket Operations Manager being final. The colours and design of the playing sweaters (including Logos) shall be uniform to all members of the same team. Each Member Board shall be required to register the pantone colours of its playing clothing with the ICC prior to its use thereof. 	<ul style="list-style-type: none"> In the event of names and/or numbers of players being carried on the playing sweaters, they shall correctly reflect the identity of the player. The number on the sweaters shall be clearly legible, positioned in the centre back of the sweater. The numbers shall be sewn on or fixed by heat transfer and not affixed by Velcro or any temporary means. The names must be positioned above or below the number on the back of the sweater and the letters used must be clearly legible. The names and numbers may not contain any advertising elements. In addition, one of the following numbers is permitted to be displayed on the playing sweaters in a position immediately below the National Logo on the front of the sweater: <ul style="list-style-type: none"> Indicating a player's order of selection for his country, or Indicating the number of caps earned by a player for his country, or Indicating a player's landmark achievement (50, 100, 150 T20s etc). Such numbers shall not be more than 2 cm (0.78 in) in height. A player's initials may be displayed on the chest or sleeve of the long sleeved sweater. Such initials shall not be more than 2 cm (0.78 in) in height. 	<ul style="list-style-type: none"> Nothing contained herein shall prevent the National Logo, the name of the country and/or the national flag or elements contained therein from being incorporated as part of the design of the playing sweaters. Players representing Member Boards who have won the ICC World Twenty20 may display a symbol on the chest or sleeve of the long sleeved playing sweater for each of the occasions that this accomplishment has been achieved. No restrictions on position. Each symbol shall not exceed 1 sq cm in size. The name of the opposing touring team or the name of the country being toured as well as the year or such tour may be displayed on the chest of the playing sweater immediately below the National Logo provided such numbers and letters shall not exceed 1 cm (0.4 in) in height. Charity ribbons/logos that are worn on team uniforms must be transferred on to the uniform. Stick on logos are also permitted. Ribbons/logos with pins are not permitted.

T20 INTERNATIONALS PLAYING SWEATER – SLEEVELESS

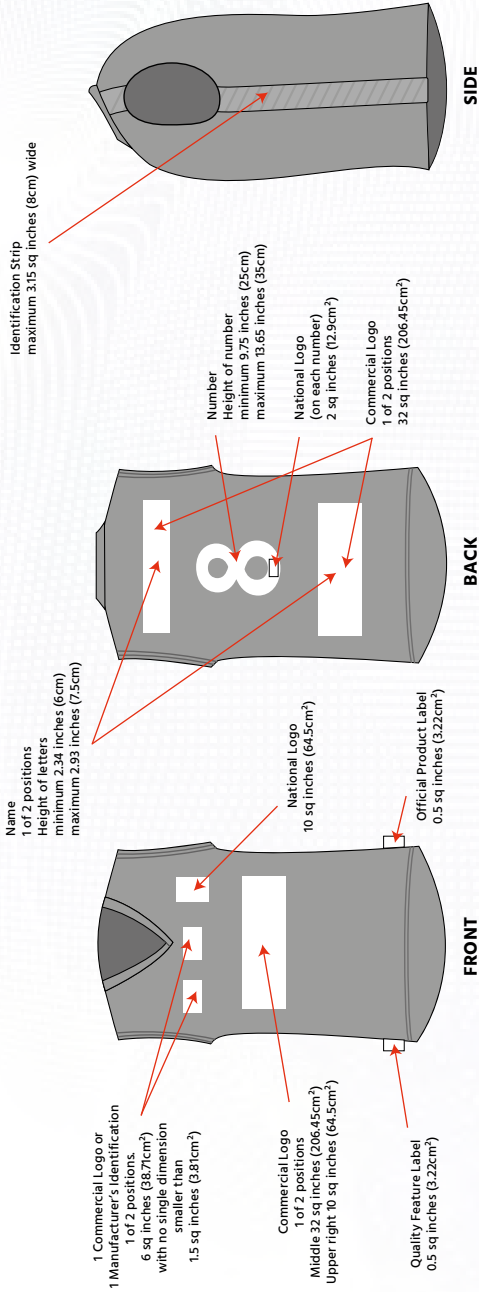

NOTE: Zips, poppers, buttons and Velcro are not permitted anywhere from the bottom up to the chest

NOTE

COLOUR AND DESIGN	NAME, NUMBER AND INITIALS	OTHER MARKS AND INSIGNIA
<ul style="list-style-type: none"> Each Member Board shall be entitled to choose the colours and design of its playing sweater subject to the following restrictions: <ul style="list-style-type: none"> The sweaters shall be coloured other than white, cream or any light colour which is likely to make the sighting of a white ball difficult, the decision of the ICC Senior Cricket Operations Manager being final. The colours and design of the playing sweaters (including Logos) shall be uniform to all members of the same team. Each Member Board shall be required to register the pantone colours of its playing clothing with the ICC prior to its use thereof. 	<ul style="list-style-type: none"> In the event of names and/or numbers of players being carried on the playing sweaters, they shall correctly reflect the identity of the player. The number on the sweaters shall be clearly legible, positioned in the centre back of the sweater. The numbers shall be sewn on or fixed by heat transfer and not affixed by Velcro or any temporary means. The names must be positioned above or below the number on the back of the sweater and the letters used must be clearly legible. The names and numbers may not contain any advertising elements. In addition, one of the following numbers is permitted to be displayed on the playing sweaters in a position immediately below the National Logo on the front of the sweater: <ul style="list-style-type: none"> Indicating a player's order of selection for his country, or Indicating the number of caps earned by a player for his country, or Indicating a player's landmark achievement (50, 100, 150 T20s etc). Such numbers shall not be more than 2 cm (0.78 in) in height. A player's initials may be displayed on the chest of the sleeveless sweater. Such initials shall not be more than 2 cm (0.78 in) in height. 	<ul style="list-style-type: none"> Nothing contained herein shall prevent the National Logo, the name of the country and/or the national flag or elements contained therein from being incorporated as part of the design of the playing sweaters. Players representing Member Boards who have won the ICC World Twenty20 may display a symbol on the chest of the playing sweater for each of the occasions that this accomplishment has been achieved. No restrictions on position. Each symbol shall not exceed 1 sq cm in size. The name of the opposing touring team or the name of the country being toured as well as the year of such tour may be displayed on the playing sweaters immediately below the National Logo provided such numbers and letters shall not exceed 1 cm (0.4 in) in height.

T20 INTERNATIONALS PLAYING SHIRT

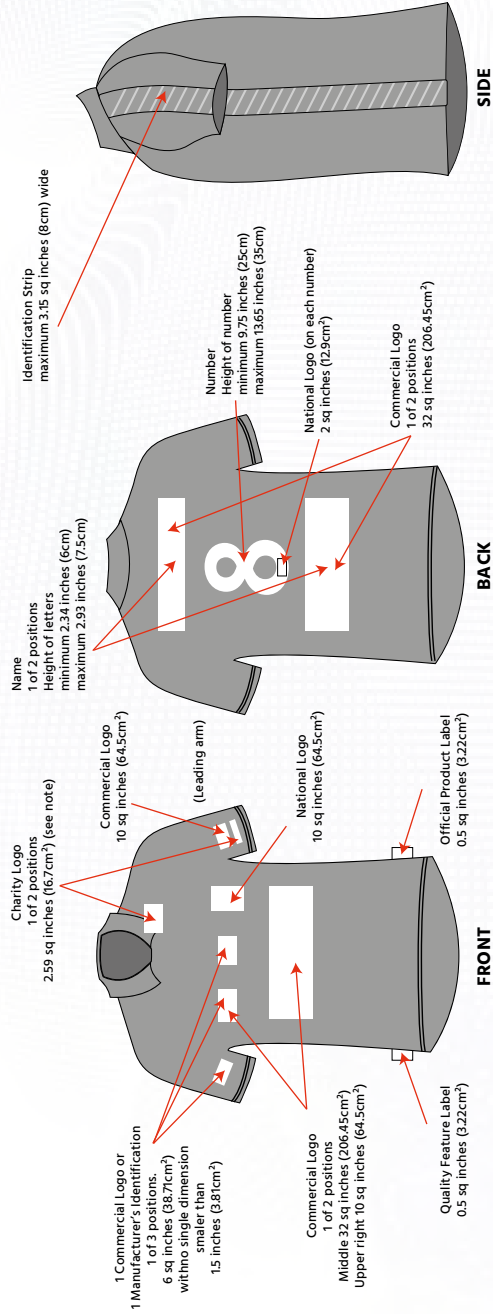

NOTE: Zips, poppers, buttons and Velcro are not permitted anywhere from the bottom up to the chest

NOTE

COLOUR AND DESIGN	NAME, NUMBER AND INITIALS	OTHER MARKS AND INSIGNIA
<ul style="list-style-type: none"> Each Member Board shall be entitled to choose the colours and design of its playing shirt subject to the following restrictions: <ul style="list-style-type: none"> The playing shirts shall be coloured other than white, cream or any light colour which is likely to make the sighting of a white ball difficult, the decision of the ICC Senior Cricket Operations Manager being final. The colours and design of the playing shirts (including Logos) shall be uniform to all members of the same team. Playing shirt sleeves may be cut to any length, as long as both sleeves are evenly trimmed and the edges are sewn and hemmed. Each Member Board shall be required to register the pantone colours of its playing clothing with the ICC prior to its use thereof. 	<ul style="list-style-type: none"> In the event of names and/or numbers of players being carried on the shirts, they shall correctly reflect the identity of the player. The number on the shirts shall be clearly legible, positioned in the centre back of the shirt. The numbers shall be sewn on or fixed by heat transfer and not affixed by Velcro or any temporary means. The names must be positioned above or below the number on the back of the shirt and the letters used must be clearly legible. The names and numbers may not contain any advertising elements. In addition, one of the following numbers is permitted to be displayed on the playing shirts in a position immediately below the National Logo on the front of the shirt: <ul style="list-style-type: none"> Indicating a player's order of selection for his country, or Indicating the number of caps earned by a player for his country, or Indicating a player's landmark achievement (50, 100, 150 T20s etc). Such numbers shall not be more than 2 cm (0.78 in) in height. A player's initials may be displayed on the chest or sleeve of the playing shirt. Such initials shall not be more than 2 cm (0.78 in) in height. 	<ul style="list-style-type: none"> Nothing contained herein shall prevent the National Logo, the name of the country and/or the national flag or elements contained therein from being incorporated as part of the design of the playing shirt. Players representing Member Boards who have won the ICC World Twenty20 may display a symbol on the chest of the playing shirt for each of the occasions that this accomplishment has been achieved. No restrictions on position. Each symbol shall not exceed 1.5 sq cm in size. The name of the opposing touring team or the name of the country being toured as well as the year of such tour may be displayed on the chest of the playing shirt immediately below the National Logo provided such numbers and letters shall not exceed 1 cm (0.4 in) in height. Charity ribbons/logos that are worn on team uniforms must be transferred on to the uniform. Stick on logos are also permitted. Ribbons/logos with pins are not permitted.

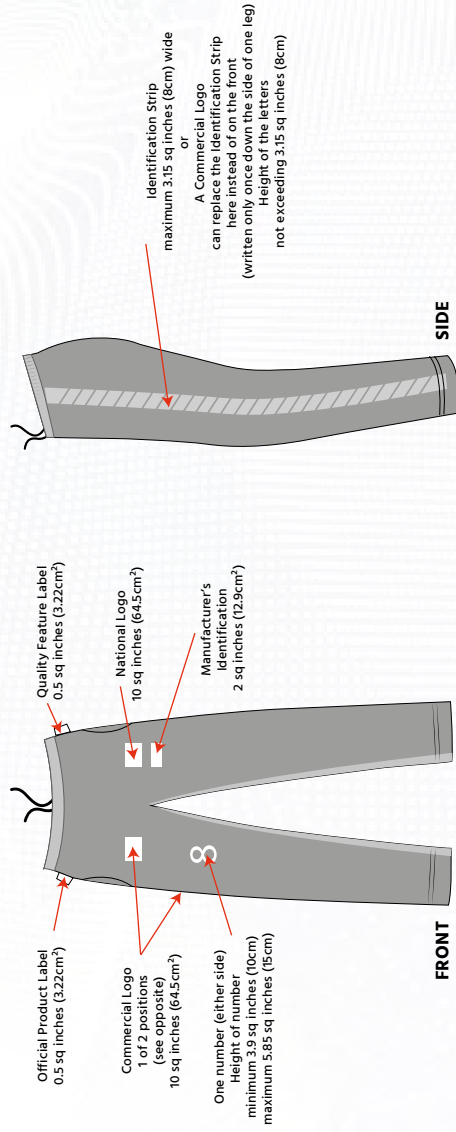

NOTE: Zips, poppers, buttons and Velcro are not permitted anywhere from the knee up to the waist

NOTE

COLOUR AND DESIGN	NAME, NUMBER AND INITIALS	OTHER MARKS AND INSIGNIA
<ul style="list-style-type: none"> Each Member Board shall be entitled to choose the colours and design of its playing trousers subject to the following restrictions: The playing trousers shall be coloured other than white, cream or any light colour which is likely to make the sighting of a white ball difficult, the decision of the ICC Senior Cricket Operations Manager being final. The colours and design of the playing trousers (including Logos) shall be uniform to all members of the same team. Each Member Board shall be required to register the pantone colours of its playing clothing with the ICC prior to its use thereof. 	<ul style="list-style-type: none"> In the event of numbers being carried on the trousers, they shall be clearly legible and positioned on the front of either leg above the knee. The numbers shall be sewn on or fixed by heat transfer and not affixed by Velcro or any temporary means. 	<ul style="list-style-type: none"> Nothing contained herein shall prevent the National Logo, the name of the country and/or the national flag or elements contained therein from being incorporated as part of the design of the playing trousers.

T20 INTERNATIONALS

PLAYING CAP AND SUN HAT

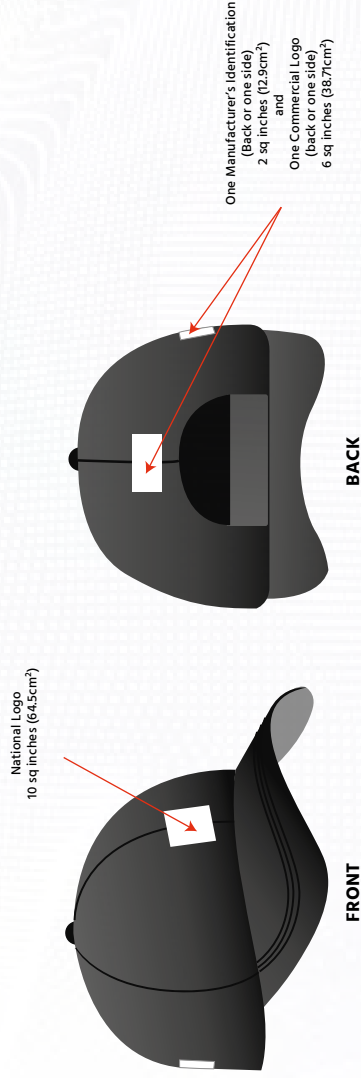

NOTE

COLOUR AND DESIGN	NAME, NUMBER AND INITIALS	OTHER MARKS AND INSIGNIA
<ul style="list-style-type: none"> Colour – Caps and sunhats must be the same colour to all members of the same team. As an alternative a white sunhat may be worn if a team issued coloured sunhat has not been provided. Design – The design of the cap and sunhat shall be uniform to all members of the same team. 	<ul style="list-style-type: none"> One of the following numbers is permitted to be displayed on the caps and sunhats in a position immediately below the National Logo or on one side: <ul style="list-style-type: none"> Indicating a player's order of selection for his country, or Indicating the number of caps earned by a player for his country, or Indicating a player's landmark achievement (50, 100, 150 T20Is etc). Such numbers shall not be more than 2 cm (0.78 in) in height. A player's initials may be displayed on the back or side of the cap or sunhat. Such initials shall not be more than 2 cm (0.78 in) in height. 	<ul style="list-style-type: none"> Nothing contained herein shall prevent the National Logo, the name of the country and/or the national flag or elements contained therein from being incorporated as part of the design of the playing cap and sunhat.

OTHER CLOTHING

TEAM TRAINING BIB

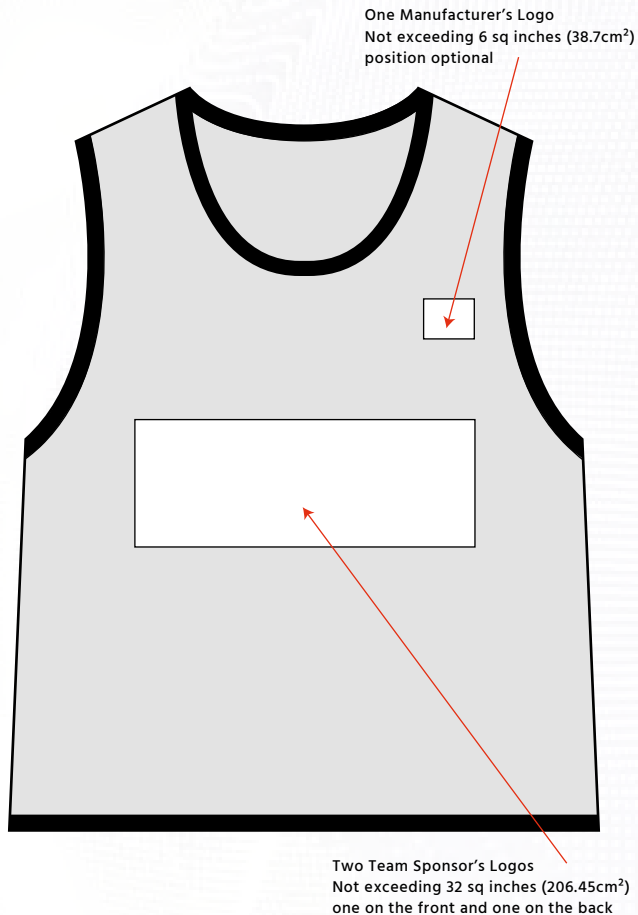

NOTE

COLOUR AND DESIGN	LOGOS
<ul style="list-style-type: none"> Of one colour and uniform to all members of the same team. Of a distinguishing colour to that of the playing shirt/sweaters. 	<ul style="list-style-type: none"> Member Logo, Country Name, Player Name and Number on shirts – No restrictions.

OTHER CLOTHING

T-SHIRTS (worn under playing shirt)



NOTE

COLOUR AND DESIGN	LOGOS
<ul style="list-style-type: none"> Test Matches – plain white. ODIs/T20Is – plain white or the same colour as the base colour of the playing shirt. 	<ul style="list-style-type: none"> No visible logos permitted.

OTHER CLOTHING

SKINS (worn under playing shirt)

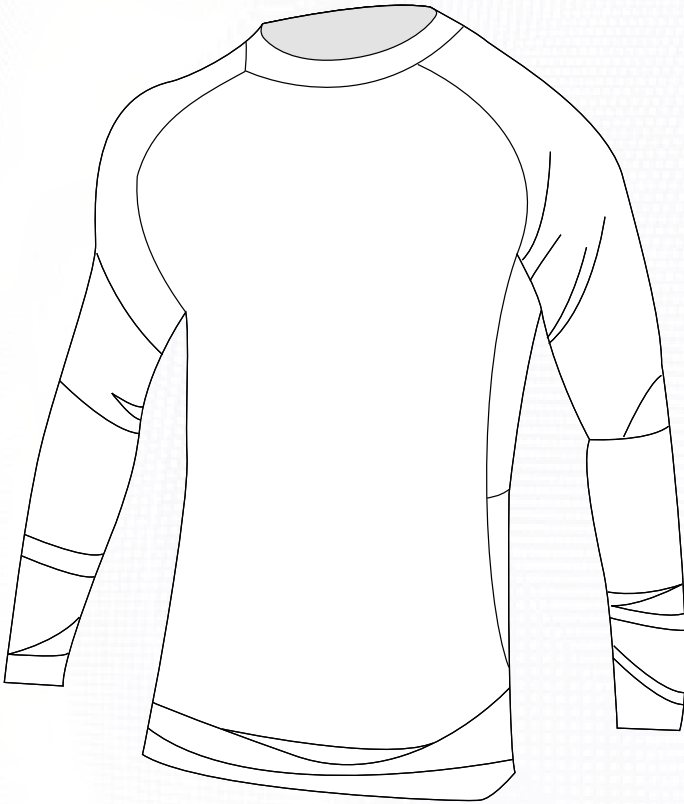

NOTE

COLOUR AND DESIGN	LOGOS
<ul style="list-style-type: none"> • Test Matches – plain white. • ODIs/T20Is – of one colour and uniform for all members of the same team; and The same colour as any colour of the playing shirt or trousers. <p>White skins may be worn provided they do not protrude from the shirt sleeves.</p>	<ul style="list-style-type: none"> • No visible logos permitted.

OTHER CLOTHING

SOCKS

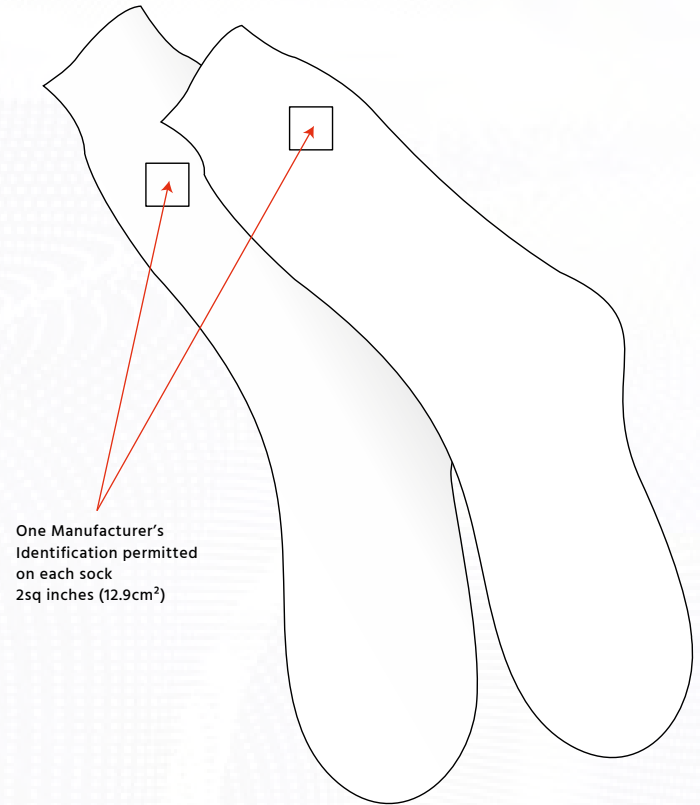

One Manufacturer's Identification permitted on each sock
2sq inches (12.9cm²)

NOTE

COLOUR AND DESIGN	LOGOS
<ul style="list-style-type: none"> • Test Matches – white, cream or light grey. • ODIs/T20Is – white, cream or light grey or the same colour as the base colour of the playing trousers. 	<ul style="list-style-type: none"> • Apart from Manufacturer's Identification, no visible logos are permitted.

OTHER CLOTHING TURBANS, BANDANAS AND HIJABS

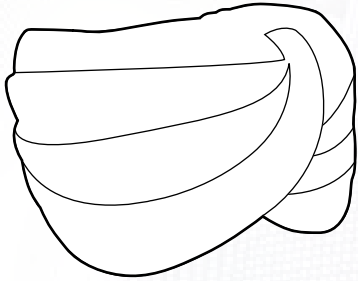

A bandana may only be worn as a cover to a turban or beneath a helmet.



The Hijab shall not cover names, numbers or logos permitted on the playing uniform.

NOTE

COLOUR AND DESIGN	LOGOS
<ul style="list-style-type: none"> • Test Matches – plain black or plain white. • ODIs/T20Is – plain black or the same plain base colour as the team cap. White is not permitted. 	<ul style="list-style-type: none"> • No visible logos permitted.

OTHER CLOTHING HEADBANDS AND WRISTBANDS

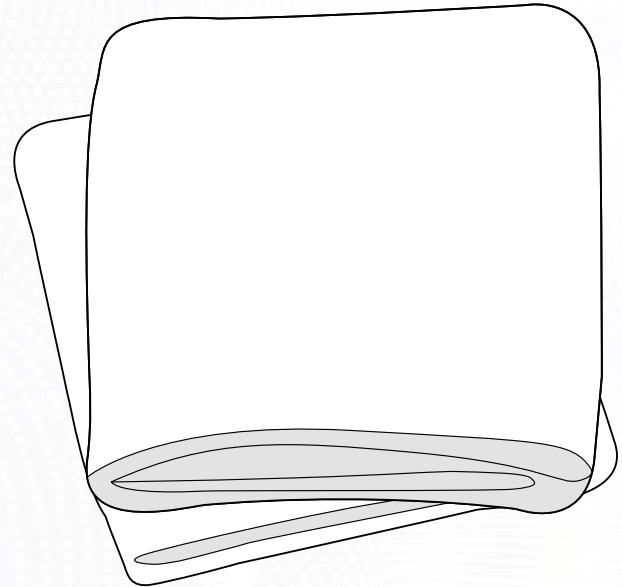

NOTE

COLOUR AND DESIGN	LOGOS
<ul style="list-style-type: none"> • Test Matches – plain white. • ODIs/T20Is – plain coloured other than white or any light colour which is likely to make the sighting of the white ball difficult, the decision of the ICC Match Referee being final. 	<ul style="list-style-type: none"> • No visible logos permitted.

CRICKET EQUIPMENT

CRICKET BAT

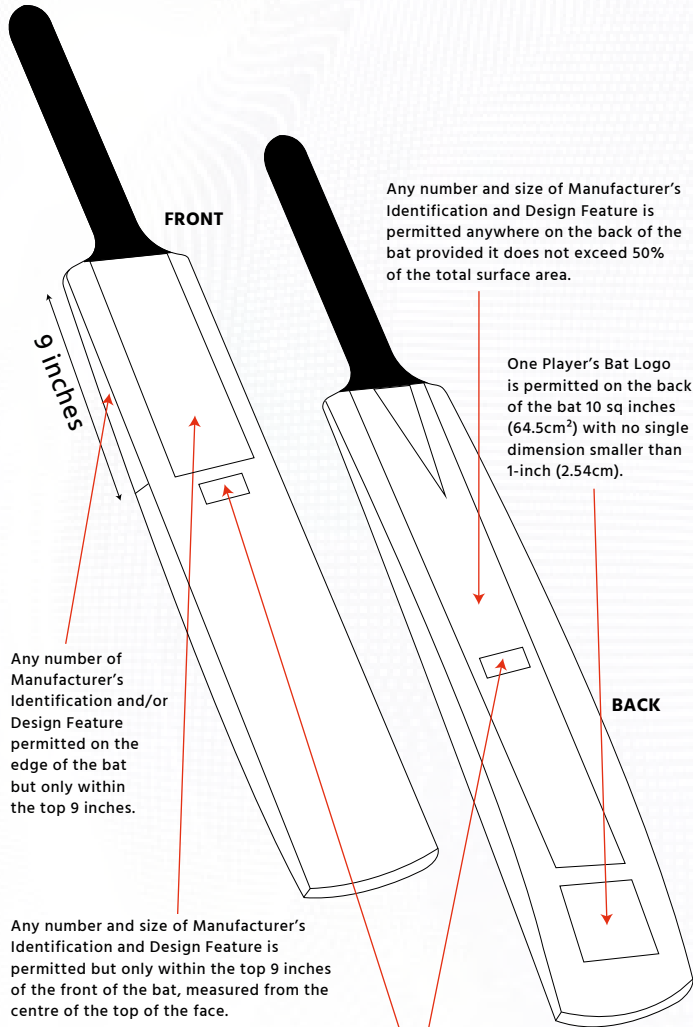

Two sets of player's initials are permitted. One set is permitted anywhere on the back of the bat. One set is permitted anywhere within the top 10 inches of the face of the bat. Such initials shall not be more than 2cm (0.78 inches) in height.

CRICKET EQUIPMENT

WICKET KEEPER GLOVES

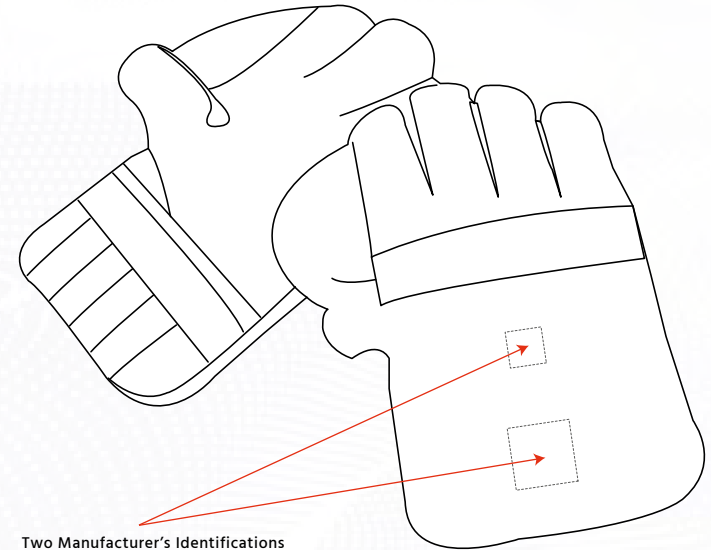

NOTE

COLOUR AND DESIGN	LOGOS
<ul style="list-style-type: none"> Any visible stitching, ventilation, stencil effect or other design aspect of the glove which is in the shape or form of the Manufacturer's Identification will be considered as the Manufacturer's Identification permitted in the diagram. 	<ul style="list-style-type: none"> No visible logos permitted other than those identified in the diagram.

CRICKET EQUIPMENT BATTING GLOVES

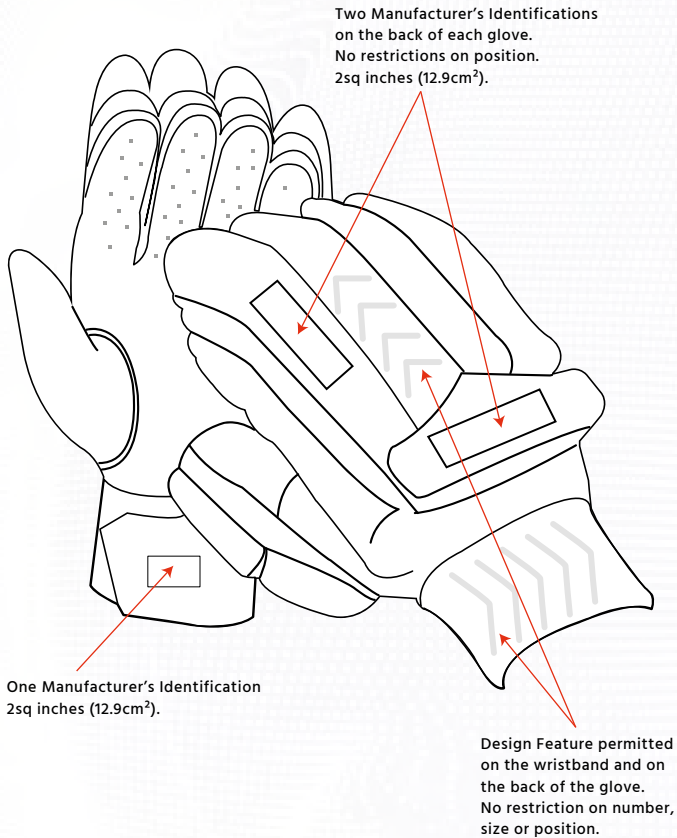

NOTE

COLOUR AND DESIGN	LOGOS
<ul style="list-style-type: none"> Test Matches – more than 50% of the protective area of the glove must be white. ODIs and T20Is – more than 50% of the protective area of the glove must be white, or the same colour as the base colour of the relevant team's playing shirt. 	<ul style="list-style-type: none"> No visible logos permitted other than those identified in the diagram.

CRICKET EQUIPMENT HELMET

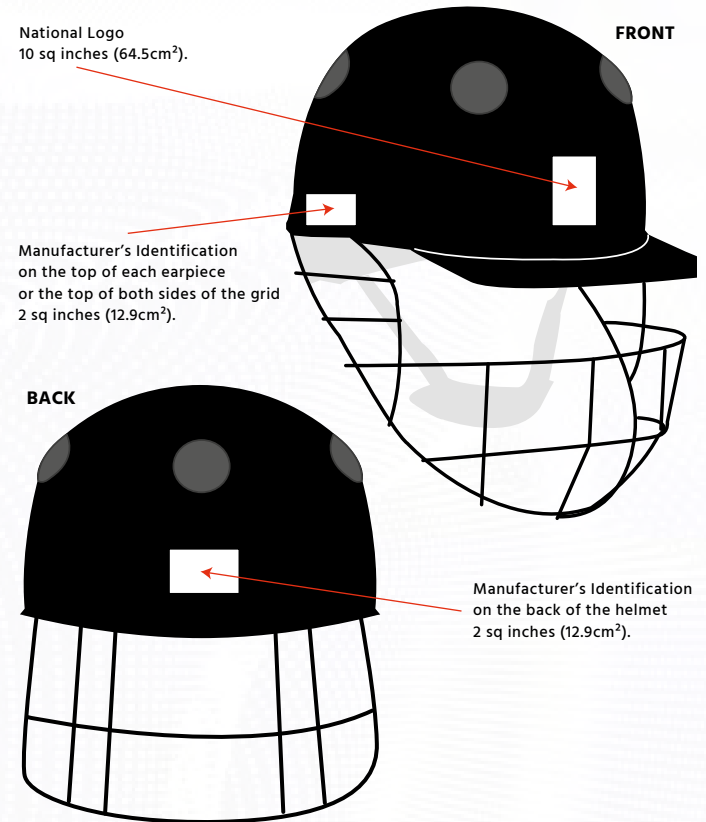

NOTE

TYPE	COLOUR AND DESIGN	LOGOS
<ul style="list-style-type: none"> While the wearing of helmets is not mandatory in international cricket, effective from 1st January 2017 all helmets worn when batting in international cricket must be certified to BS7928:2013. 	<p>In all formats of the game:</p> <ul style="list-style-type: none"> Helmets shall be one plain colour. The colour of the helmet shall be uniform to all members of the same team. 	<ul style="list-style-type: none"> No visible logos permitted other than those identified in the diagram.

CRICKET EQUIPMENT WICKET KEEPER PADS

One Manufacturer's Identification in 1 of 2 positions on the front of pad 4 sq inches (25.81cm²).

One Manufacturer's Identification inside top of pad no size restriction.

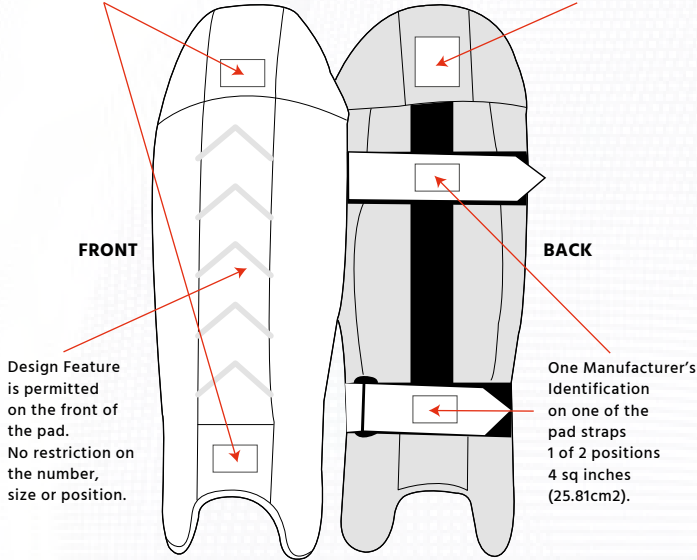

Design Feature is permitted on the front of the pad. No restriction on the number, size or position.

One Manufacturer's Identification on one of the pad straps 1 of 2 positions 4 sq inches (25.81cm²).

NOTE

TEST MATCHES	ODIs AND T20Is
<ul style="list-style-type: none"> • Pads shall be plain white save that the straps may be in the house colours of the Manufacturer. • Coloured piping shall be permitted below the ankle strap of the pad only. • Design Feature shall be white only. 	<ul style="list-style-type: none"> • Pads shall be plain coloured other than white or any light colour which is likely to make the sighting of the white ball difficult, the decision of the ICC Match Referee being final. The straps may be in the house colours of the Manufacturer. • Design Feature shall be the same colour as the colour of the pad. • The colour of the pads must be properly maintained. Discoloured or faded pads will not be permitted. • Clads are permitted. A Clad is a coloured cover that goes over a white pad. When used, the Clad logo can replace the existing Manufacturer's Identification on the front of the pad. In such cases, the existing Manufacturer's Identification on the inside top of the pad and the pad straps are still permitted to be displayed.

CRICKET EQUIPMENT BATTING PADS

Design Feature is permitted on the front of the pad. No restriction on the number, size or position same colour as the pad. (see note)

One Manufacturer's Identification inside top of pad no size restriction.

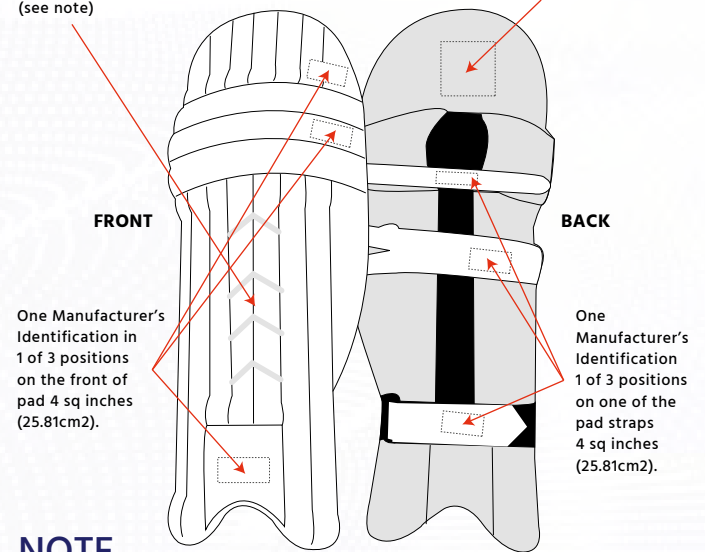

One Manufacturer's Identification in 1 of 3 positions on the front of pad 4 sq inches (25.81cm²).

One Manufacturer's Identification 1 of 3 positions on one of the pad straps 4 sq inches (25.81cm²).

NOTE

TEST MATCHES	ODIs AND T20Is
<ul style="list-style-type: none"> • Pads shall be plain white save that the straps may be in the house colours of the manufacturer. • Coloured piping shall be permitted below the ankle strap of the pad only. • Design features shall be white only. 	<ul style="list-style-type: none"> • Pads shall be plain coloured other than white or any light colour which is likely to make the sighting of the white ball difficult, the decision of the ICC Match Referee being final. The straps may be in the house colours of the Manufacturer. • Design features shall be the same colour of the pad. • The colour of the pads shall be uniform to all members of the same team. • The colour of the pads must be properly maintained. Discoloured or faded pads will not be permitted. • Clads are permitted. A Clad is a coloured cover that goes over a white pad. When used, the Clad logo can replace the existing Manufacturer's Identification on the front of the pad. In such cases, the existing Manufacturer's Identification on the inside top of the pad and the pad straps are still permitted to be displayed.

CRICKET EQUIPMENT SHOES AND BOOTS



Any number and size of Manufacturer's Identification and Design Feature is permitted anywhere on the upper provided it does not exceed 30% of the total surface area. Any written name, initials or word used as a Manufacturer's Identification shall not exceed 2 square inches (12.9cm²).

One Manufacturer's Identification may be displayed on the sole. No size restriction.

NOTE

TEST MATCHES	ODIs AND T20Is
<ul style="list-style-type: none"> Minimum of 70% white inclusive of tongue and laces. No restriction in colour for remaining 30%. 	<ul style="list-style-type: none"> Minimum of 70% white inclusive of tongue and laces. No restriction in colour for remaining 30%. Alternatively, the shoe/boot may be in the same colour as the playing kit.

CRICKET EQUIPMENT SUN GLASSES

Two Manufacturers Identification are permitted, one on either side of the frame, not exceeding 0.5 sq inches (3.22cm²).

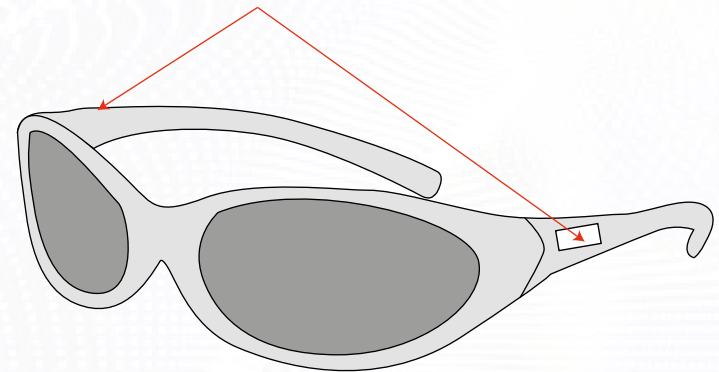

NOTE

COLOUR AND DESIGN	LOGOS
<ul style="list-style-type: none"> No restrictions on colour save that sunglasses strap/band must be of a single colour. 	<ul style="list-style-type: none"> No visible logos permitted other than those identified in the diagram.

CRICKET EQUIPMENT ARM GUARDS

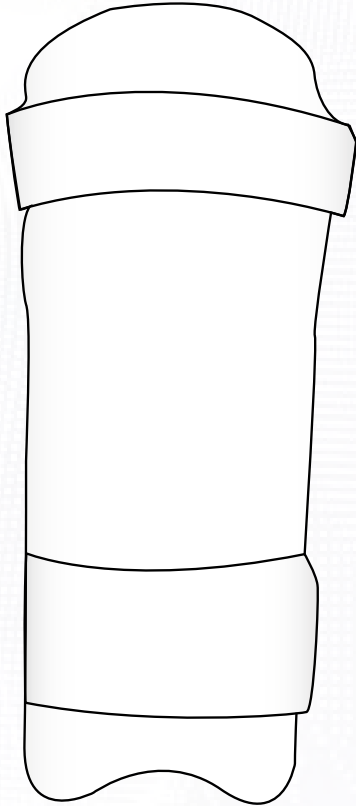

NOTE

COLOUR AND DESIGN	LOGOS
<ul style="list-style-type: none"> • Test Matches – plain white save that the straps may be in the house colours of the Manufacturer. • ODIs/T20Is – plain white or the same colour as the base colour of the Playing shirt. Straps may be in the house colours of the Manufacturer. 	<ul style="list-style-type: none"> • No visible logos.

CRICKET EQUIPMENT FACE PROTECTORS

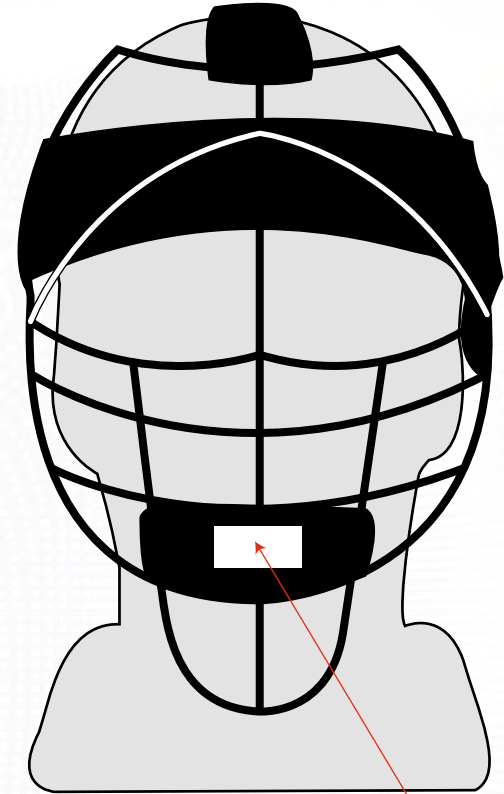

One Manufacturer's Identification is permitted. No restrictions on position. 2 sq inches (12.9cm²).

NOTE

COLOUR AND DESIGN	LOGOS
<ul style="list-style-type: none"> • The face protector shall be one plain colour. 	<ul style="list-style-type: none"> • No visible logos permitted other than those identified in the diagram.

CRICKET EQUIPMENT STUMPS

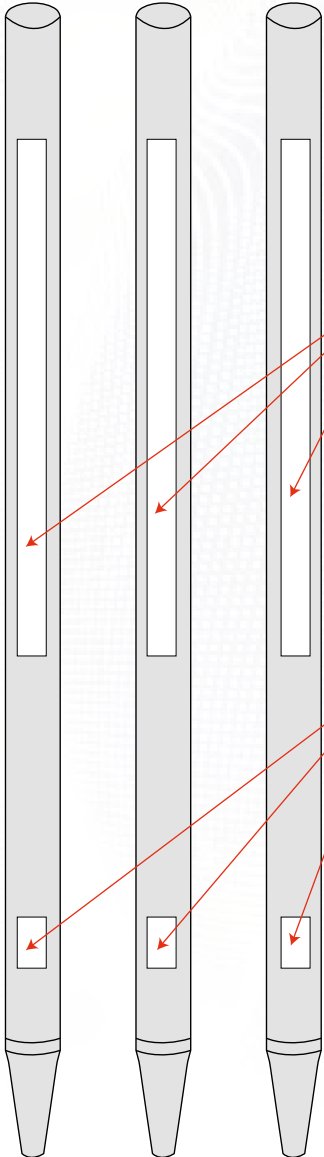

Test Matches: No regulation covering the colour of the stumps.

ODI's & T20's: No regulation covering the colour of the stumps save that the bails shall be of a distinguishing colour to that of the stumps.

Logos: The Event Logo and / or the Logo of the series or the sponsors may be displayed on each of the stumps. No size restriction. National Logos are not permitted on the stumps.

Two Manufacturer's Identifications are permitted on each stump-one on the front and one on the back not exceeding 2sq inches (12.9cm²).

CRICKET EQUIPMENT THIGH PADS, SHIN PADS AND OTHER EQUIPMENT

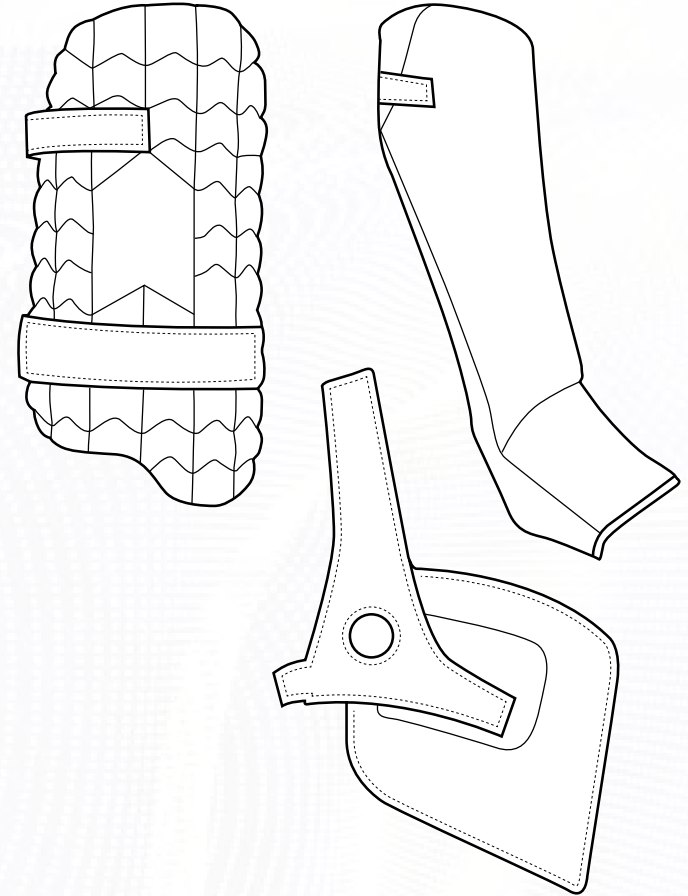

NOTE

COLOUR AND DESIGN

- No restriction on colours save that these items must be worn under playing clothing and shall not be visible.

LOGOS

- No visible logos shall be permitted.

APPENDIX 2

DISCIPLINARY PROCESS

ARTICLE 1 – REPORTING AN ALLEGED OFFENCE

- 1.1 Any one of the following individuals can report an alleged offence under the Regulations by lodging a report in the manner described in Article 1.2 below (a 'Report'):
- 1.1.1 any Umpire;
 - 1.1.2 any Referee; or
 - 1.1.3 any member of the ICC's Cricket Operations Department.
- 1.2 A Report must be lodged by way of an e-mail to the ICC's Senior Cricket Operations Manager. All Reports must (a) clearly identify the person lodging the Report; (b) identify the relevant International Match in which the breach was alleged to have been committed; (c) identify the individual, whether that be a player, team official or Board, who is alleged to have committed the offence; and (d) in the case of non-televised matches, include a photograph of the offending clothing or equipment taken during the International Match where the breach was alleged to have been committed. In the case of Reports lodged by any of the individuals listed in Articles 1.1.1 and 1.1.2, in addition to the e-mail, details of the alleged breach shall be included on the Umpire or Match Referee's daily log (where applicable) filed with the ICC Cricket Operations Department at the end of each day's play.
- 1.3 All Reports must be lodged with the ICC's Senior Cricket Operations Manager within seven (7) days of conclusion of the relevant International Match.
- 1.4 Where a player, team official or Board is alleged to have committed more than one breach of the Regulations during an International Match (whether arising out of the same set of facts or otherwise), then a separate Report should be filed in accordance with this Article 1 for each of the breaches that are alleged to have been committed.

ARTICLE 2 – NOTIFICATION PROCEDURE

- 2.1 Where the ICC's Senior Cricket Operations Manager receives a Report, he/she must promptly conduct a review to determine whether the player, team official or Board named in the Report has a case to answer.
- 2.2 If the initial review of the Report reveals that there is no case to answer, then the ICC's Senior Cricket Operations Manager shall notify the person who filed the Report of that fact, and the matter shall not proceed any further.
- 2.3 If the initial review of the Report reveals that there is a case to answer, then the ICC's Senior Cricket Operations Manager shall promptly provide a copy of the Report, together with copies of the photographic/video snapshot evidence supporting the Report and Form 'CE Not 1' (such documents comprising the 'Notice of Charge') to the following individuals:
- 2.3.1 the player or team official named in the Report (where relevant);
 - 2.3.2 the Team Manager of the relevant player or team official named in the Report (where relevant); and
 - 2.3.3 the CEO of the Board (or his/her designee) to which the relevant player or team official is affiliated, or, in the case of a breach by the Board itself, the CEO of the relevant Board (or his/her designee).

- 2.4 The Notice of Charge shall specify that the player, team official or relevant Board shall have the following options which must be exercised through notice to the ICC's Senior Cricket Operations Manager within seven (7) days of receipt by the player, team official or Board of the Notice of Charge:
- 2.4.1 he/she/it may admit the offence charged and accede to the sanction proposed in the Notice of Charge (which sanction shall comply with the sanctions set out in Article 4), in which case adjudication shall not be required and no further action shall be taken; or
 - 2.4.2 he/she/it may admit the offence charged but dispute the sanction proposed in the Notice of Charge, in which case the matter shall proceed to adjudication in accordance with Article 3; or
 - 2.4.3 he/she/it may deny the offence charged, in which case, the matter shall proceed to adjudication in accordance with Article 3.
- 2.5 Where the player, team official or Board either disputes the sanction proposed under Article 2.4.2, or denies the offence charged under Article 2.4.3, his/her/its response to the Notice of Charge must be supported by a written statement, in English, explaining why the player, team official or Board does not admit the offence and/or accept the proposed sanction, and any documentary evidence that the player, team official or National Cricket Federation relies on in support.

ARTICLE 3 – THE DISCIPLINARY PROCEDURE

- 3.1 Where a matter proceeds to adjudication under Article 2.4.2 or 2.4.3, then the case shall be referred to the ICC's General Manager – Cricket who shall decide the matter solely on the basis of the Notice of Charge and any written statement filed by the player, team official or Board in accordance with Article 2.5. The ICC's General Manager – Cricket shall not hold an oral hearing. However, should the ICC's General Manager – Cricket consider that further information is necessary to allow him to make his decision, he shall be entitled to obtain such further information before making his decision, and the relevant player, team official or Board shall assist him in this regard, where requested. In considering the matter, the ICC's General Manager – Cricket shall be entitled to consult with the ICC's General Counsel.
- 3.2 Save in exceptional circumstances, the ICC's General Manager – Cricket shall notify his written reasoned decision, setting out: (a) the finding as to whether an offence under the Regulations has been committed; (b) the sanction, if any, to be imposed (in accordance with Article 4); (c) details of which match or matches any suspension is to be applied to; and (d) any right of appeal that exists pursuant to Article 5, within seven (7) days of receipt of the response to the Notice of Charge. A copy of the decision shall be sent to the CEO of the player or team official's Board (or his/her designee) and the ICC's Senior Cricket Operations Manager.
- 3.3 Subject only to the rights of appeal under Article 5, the ICC's General Manager – Cricket Operations' decision shall be the full, final and complete disposition of the matter and will be binding on all parties.

ARTICLE 4 – SANCTIONS

- 4.1 Where the ICC’s Senior Cricket Operations Manager determines that there is a case to answer in accordance with Article 2.1, in issuing the Notice of Charge, he/she shall specify (on Form Not 1) the appropriate sanction to be imposed on the player, team official or Board.
- 4.2 In addition, where a matter comes before the ICC’s General Manager – Cricket in accordance with either Article 2.4.2 or 2.4.3, and he/she determines that an offence under these Regulations has been committed, he/she will be required to impose an appropriate sanction on the player, team official or Board.
- 4.3 In order to determine the sanction that is to be imposed in each case, the ICC’s Senior Cricket Operations Manager or ICC’s General Manager – Cricket (as appropriate) must first consider whether the player, team official or National Cricket Federation has previously been found guilty of an offence in the same category under the Regulations within a period of twelve (12) months prior to the date on which the alleged offence took place.

NOTE: For example, if a player is found to have breached these Regulations in respect of a Commercial Logo, he/she shall only be considered to have committed a repeat offence if, within the twelve month period prior to the date of the alleged offence, he/she was found guilty of a breach of these Regulations in relation to any Commercial Logo. If the previous breach had related, for example, to a Charity Logo, it would not count as a repeat offence for the purposes of this Article 4.3.

- 4.4 Once the ICC’s Senior Cricket Operations Manager or ICC’s General Manager – Cricket (as appropriate) has established whether this is a repeat offence within the relevant twelve month period, then he/she shall go on to take into account any other factors that he/she deems relevant and appropriate to the mitigation or aggravation of the nature of the offence (including, without limitation, the nature and frequency of any previous offences under the Regulations) before determining, in accordance with the following table, what the appropriate sanction should be.

CATEGORY OF OFFENCE	SANCTION – FIRST OFFENCE	SANCTION – SECOND OFFENCE WITHIN 12 MONTHS	SANCTION – THIRD OFFENCE WITHIN 12 MONTHS	SANCTION – FOURTH OFFENCES WITHIN 12 MONTHS
PLAYERS				
Non-Commercial Logo, Charity Logo or other breach	Reprimand.	The imposition of a fine of 25% of the applicable Match Fee.	The imposition of a fine of 50% of the applicable Match Fee.	The imposition of a fine of 75% of the applicable Match Fee.
Manufacturer’s Logo	The imposition of a fine of 25% of the applicable Match Fee.	The imposition of a fine of 50% of the applicable Match Fee.	The imposition of a fine of 100% of the applicable Match Fee.	The imposition of a 1 match suspension.
Player’s Bat Logo (excluding Charity Logo)	The imposition of a fine of 50% of the applicable Match Fee.	The imposition of a fine of 75% of the applicable Match Fee.	The imposition of a fine of 100% of the applicable Match Fee.	The imposition of a 1 match suspension.
Commercial Logo	The imposition of a fine of 50% of the applicable Match Fee.	The imposition of a fine of 75% of the applicable Match Fee.	The imposition of a fine of 100% of the applicable Match Fee.	The imposition of a 1 match suspension.
Betting Logo	The imposition of a fine of 75% of the applicable Match Fee.	The imposition of a fine of 100% of the applicable Match Fee.	The imposition of a 1 match suspension.	The imposition of a minimum 2 match suspension.
Non-Compliant Helmet	First Warning.	Second Warning.	The imposition of a 1 match suspension.	The imposition of a 2 match suspension.
National Cricket Federations				
All Categories	Warning and/or the imposition of a fine up to a maximum of US\$25,000.	The imposition of a fine up to a maximum of US\$25,000.	The imposition of a fine up to a maximum of US\$25,000.	The imposition of a fine up to a maximum of US\$25,000.

NOTE: For the purposes of this Appendix 2, Match Fee means the designated match fee (which is to be used for the purposes of calculating sanctions in accordance with Article 4 of Appendix 2) as set out in Appendix 3 to these Regulations.

- 4.5 Where a player or team official has been suspended for a specific number of matches, the suspension will be applied in accordance with the following principles:
- 4.5.1 the ICC's Senior Cricket Operations Manager or the ICC's General Manager – Cricket (as appropriate) shall have regard to the player or team official's participation in the various formats of International Matches over the previous two years in order to determine (to the best of his/her ability) which of the forthcoming International Matches the player or team official is most likely to participate in;
- 4.5.2 in so far as is reasonably possible, the ICC's Senior Cricket Operations Manager or the ICC's General Manager – Cricket (as appropriate) shall apply the suspension to the subsequent International Matches in which the player or team official is likely to participate in, on a chronological basis immediately following the announcement of the decision;
- 4.5.3 where a player of team official has his/her suspension applied to an International Match that is subsequently cancelled, postponed or otherwise abandoned prior to the actual day on which it is scheduled to take place, then such suspension must be reallocated to the next subsequent International Match in which the player or team official is likely to participate in. Where an International Match is cancelled, postponed or otherwise abandoned at any time on the actual day on which it is scheduled to take place, then the suspension will remain allocated to that International Match, irrespective of such cancellation, postponement or abandonment.

EXAMPLES OF THE APPLICATION OF SUSPENSION POINTS:

- 1 Where a player's playing history suggests that he/she is most likely to represent his National Cricket Federation in Test Matches only, then the suspension shall be applied to his/her future participation in Test Matches only, so that a one match suspension would be applied to the Test Match immediately following the announcement of the decision, notwithstanding that the National Cricket Federation might be participating in intervening One Day International Matches and/or Twenty20 International Matches.
- 2 Where a player's playing history suggests that he/she is likely to be selected to represent his National Cricket Federation in all formats of International Matches, then the suspension shall be applied to his/her future participation in all International Matches in the sequential order in which such International Matches take place immediately following the announcement of the decision. For example, if a player received a two match suspension, and the following chronological list of potential playing fixtures represented the player's National Cricket Federation's upcoming International Matches:
 - Announcement of decision
 - One-Day International Match – **Match A**
 - Test Match – **Match B**
 - Twenty20 International Match – **Match C**

the player's suspension would be applied to Matches A and B, and he would be entitled to return to participation in Match C.

- 4.6 Where a fine is imposed against a player or team official, then such fine must be paid: (a) by the player or team official (and not any third party, including a Board); (b) to the player or team official's Board (for onward transmission to the ICC) within one calendar month of receipt of the decision imposing the fine. However, the ICC will consider any request from any player or team official to make payment of such fines over a prolonged period of time on the grounds of financial hardship. Should any fine (or agreed part-payment or instalment thereof) not be paid to the relevant Board within such deadline or by the time of the next agreed payment date, the player or team official may not play, coach or otherwise be involved in any capacity in any International Match until such payment has been satisfied in full.
- 4.7 Where a player or team official has had a suspension imposed against him/her, he/she may not play, coach or otherwise participate or be involved in any capacity in the International Match(es) which are covered by the application of his suspension as determined in accordance with Article 4.5.

NOTE: For the avoidance of any doubt, a player who has had a suspension imposed against him/her shall not, during the International Matches which are covered by his/her suspension:

- a) be nominated as, or carry out any of the duties or responsibilities of, a substitute fielder; or
- b) enter any part of the playing area (which shall include, for the avoidance of doubt, the field of play and the area between the boundary and perimeter boards) at any time, including during any scheduled or unscheduled breaks in play.

In addition, a team official so sanctioned shall not be permitted to enter the player's dressing room (including the viewing areas) during any International Match covered by his suspension. Players so sanctioned, however, will be permitted to enter the players' dressing room provided that the players' dressing room (or any part thereof) for the relevant International Match is not within the player area described in (b) above (for example, no such Player shall be permitted access to an on-field 'dug-out').

Finally, any player or team official so sanctioned shall not be prevented from attending any post-match ceremonies or presentations taking place anywhere on the field of play or otherwise following the conclusion of an International Match covered by his/her suspension.

- 4.8 Once any suspension has expired, the player or team official will automatically become re-eligible to participate in International Matches provided that he/she has paid, in full, all amounts forfeited under these Regulations, including any fines that may have been imposed against him/her.

ARTICLE 5 – APPEALS

- 5.1 Appeals from decisions in relation to which a reprimand and/or fine is imposed
- 5.1.1 Decisions made under these Regulations by the ICC's General Manager – Cricket in relation to which a reprimand and/or fine is imposed shall be non-appealable and shall remain the full and final decision in relation to the matter.
- 5.2 Appeals from decisions in relation to which a suspension is imposed
- 5.2.1 Decisions made by the ICC's General Manager – Cricket in relation to which a suspension is imposed may be challenged solely by appeal as set out in this Article 5.2. Such decision shall remain in effect while under appeal unless the ICC's Chief Executive Officer properly convened to hear the appeal orders otherwise.
- 5.2.2 The only parties who may appeal a decision of this nature shall be the player, team official or Board found guilty of an offence under these Regulations.
- 5.2.3 Any notice to appeal under this Article must be lodged with the ICC's Chief Executive Officer (with a copy to the ICC's General Counsel) within fourteen (14) days of receipt of the written decision of the ICC's General Manager – Cricket (the '**Notice of Appeal**'). In cases where a player or team official files a Notice of Appeal, a copy of such notice will also be provided to the CEO of the National Cricket Federation (or his/her designee) to which the player or team official is affiliated. The Notice of Appeal shall include a written statement setting out, in detail, the grounds for appeal of the decision, together with any documents that the player, team official or Board wishes to rely on in support of the appeal.
- 5.2.4 Thereafter, the ICC's Chief Executive Officer shall decide the matter solely on the basis of the Notice of Appeal and supporting documents, and the original Notice of Charge. The ICC's Chief Executive Officer shall not hold an oral hearing. However, should the ICC's Chief Executive Officer consider that further information is necessary to allow him to make his decision, he shall be entitled to obtain such further information before making his decision, and the relevant player, team official or Board shall assist him in that regard, where requested. In considering the matter, the ICC's Chief Executive Officer shall be entitled to consult with the ICC's General Counsel.
- 5.2.5 Save in exceptional circumstances, the ICC's Chief Executive Officer shall notify his written reasoned decision, setting out: (a) the finding as to whether an offence under the Regulations has been committed; (b) the sanction, if any, to be imposed (in accordance Article 4); and (c) details of which match or matches any suspension is to be applied to, within fourteen (14) days of receipt of the receipt of the Notice of Appeal. A copy of the decision shall be sent to the CEO of the player or team official's Board (or his/her designee) and the ICC's Senior Cricket Operations Manager.
- 5.2.6 Any decision made by the ICC's Chief Executive Officer under this Article 5.2 shall be the full, final and complete disposition of the matter and will be binding on all parties.

- 5.3 No appeal in relation to an accepted sanction

- 5.3.1 For the avoidance of doubt, where a player, team official or Board admits the offence charged and accedes to the sanction specified in the Notice of Charge in accordance with the procedure described in Article 2.4.1, the player, team official or Board waives his/her/its right to any appeal against the imposition of such a sanction.

ARTICLE 6 – RECOGNITION OF DECISIONS

- 6.1 Any final adjudications under these Regulations shall be recognised and respected by the ICC and its Member Boards automatically upon receipt of notice of the same, without the need for any further formality. Each of the ICC and its Member Boards shall take all steps legally available to it to enforce and give effect to such decisions.
- 6.2 It shall be a condition of membership of the ICC that all National Cricket Federations shall comply with the Regulations.

ARTICLE 7 – GOVERNING LAW

- 7.1 These Regulations are governed by and shall be construed in accordance with English law. Strictly without prejudice to the arbitration provisions of Articles 3 and 5 of the Regulations, disputes relating to the Regulations shall be subject to the exclusive jurisdiction of the English courts.

APPENDIX 3

MATCH FEES

Unless otherwise agreed in advance of an International Match or ICC Event, for the purposes of any sanctions that are to be applied pursuant to these Regulations, the following designated Match Fees shall apply:

TYPE OF INTERNATIONAL MATCH	DESIGNATED MATCH FEE
Any men's Test Match, One Day International Match or Twenty20 International Matches.	A country-specific amount which is to be determined by the ICC's Chief Executive's Committee in consultation with the relevant National Cricket Federations.
All other International Matches.	No Match Fee will be applied. Accordingly, neither the ICC's Senior Cricket Operations Manager or the ICC's General Manager – Cricket shall have jurisdiction under these Regulations to impose any financial sanctions against any Player or Player Support Personnel for a breach of these Regulations. However the remaining range of permissible sanctions (set out in the tables in Article 4.4 of Appendix 2) shall be available to ICC's Senior Cricket Operations Manager or the ICC's General Manager – Cricket in full.

For the avoidance of doubt, the designated Match Fee to be applied for the purposes of an offence committed by a Player Support Personnel shall be the same as that which would be applied to a Player from the same National Cricket Federation participating in the same International Match.

ICC SAFEGUARDING REGULATIONS

ICC SAFEGUARDING REGULATIONS

ARTICLE 1 – INTRODUCTION

- 1.1 The ICC is the international federation responsible for the global governance of the sport of cricket. It is also the organiser of various international cricket events (the ICC Events).
- 1.2 The ICC recognises that ensuring the welfare of all those participating in cricket is important in its own right, but it is also vital for the good reputation of cricket and its long-term health and vitality at all levels. Accordingly, the ICC expects all National Cricket Federations and Participants to maintain appropriate standards and behaviour in relation to their welfare and that of other people around them at all times.
- 1.3 The core aim of these ICC Safeguarding Regulations is to ensure the welfare of Protected Persons. These ICC Safeguarding Regulations establish a framework through which the ICC may address matters concerning the harm, or possibility of harm, to Protected Persons in connection with ICC Events.
- 1.4 Words in italicised text in these ICC Safeguarding Regulations are defined terms. Their respective definitions are set out in Appendix 1.

ARTICLE 2 – SCOPE AND APPLICATION

- 2.1 These ICC Safeguarding Regulations apply to Participants. For these purposes, a “Participant” is:
 - 2.1.1 any cricketer who is selected as part of a team or squad to participate in an ICC Event, or who otherwise participates in an ICC Event; and/or
 - 2.1.2 any coach, trainer, manager, selector, official, doctor, physiotherapist or any other person who is employed by, represents or is otherwise affiliated to team or squad that participates in an ICC Event; and/or
 - 2.1.3 any ICC Official, Match Referee, Pitch Curator, Player Agent, Umpire or Umpire Support Personnel involved in an ICC Event; and/or
 - 2.1.4 any other individual who participates in any official capacity, on behalf of the ICC, a National Cricket Federation or ICC Event organising committee, during the course of an ICC Event; and/or
 - 2.1.5 any other person who from time to time is engaged directly or indirectly in any activity on behalf of the ICC, a National Cricket Federation or ICC Event organising committee, in relation to the organisation or administration of an ICC Event.
- 2.2 Each Participant is automatically bound by these ICC Safeguarding Regulations as soon as he/she becomes a Participant. From that point, he/she shall be deemed to have agreed:
 - 2.2.1 not to engage in Prohibited Conduct in connection with ICC Events;
 - 2.2.2 that it is his/her personal responsibility to familiarise him/herself with all of the requirements of these ICC Safeguarding Regulations, and to comply with those requirements (where applicable);

- 2.2.3 to submit to the jurisdiction of the ICC to investigate apparent or suspected Prohibited Conduct;
- 2.2.4 to submit to the jurisdiction of the Safeguarding Chairperson and/or Safeguarding Panel convened under these ICC Safeguarding Regulations to hear and determine, (a) any allegation that a Participant has engaged in Prohibited Conduct; and (b) any related issue (e.g., any challenge to the validity of the charges or to the jurisdiction of the ICC or Safeguarding Chairperson or Safeguarding Panel, as applicable);
- 2.2.5 to submit to the jurisdiction of any Safeguarding Appeal Panel to determine appeals made pursuant to these ICC Safeguarding Regulations;
- 2.2.6 not to bring any proceedings in any court or other forum that are inconsistent with the foregoing submissions to the jurisdiction of the Safeguarding Chairperson, Safeguarding Panels or Safeguarding Appeal Panels; and
- 2.2.7 to waive and forfeit any rights, defences and privileges provided by any law in any jurisdiction to withhold, or reject the provision of, information requested by the ICC pursuant to any investigation under these ICC Safeguarding Regulations.

NOTE:

For the avoidance of doubt, the ICC's jurisdiction to take action against a Participant under these ICC Safeguarding Regulations is limited to Prohibited Conduct taking place in connection with an ICC Event.

Whether or not a Participant's conduct takes place - or he/she poses a risk of harm (in the context of Article 3.1, below) - in connection with an ICC Event, will inevitably involve a fact-specific analysis. However, without limitation to the generality of the foregoing, the closer in time conduct takes place to the duration of an ICC Event (obviously during, but also before and after) the more likely it is that such conduct will be considered to take place 'in connection' with an ICC Event. By way of general proposition, for Participants who are present in the host territory for the purposes of their participation or other involvement in an ICC Event, conduct that takes place in the period beginning 7 (seven) days prior to the first match of an ICC Event and ending at the time of the Participant's departure from the host territory, will constitute conduct taking place 'in connection' with an ICC Event. However, for Participants who are involved with the organisation or administration of an ICC Event, or when considering whether or not a Participant poses a risk of harm, a longer period of time may be considered to be 'in connection' with an ICC Event.

- 2.3 These ICC Safeguarding Regulations are not criminal laws but rather disciplinary rules of professional conduct for those involved in the sport of cricket. However, Prohibited Conduct may also be a criminal offence and/or a breach of other applicable laws or regulations. These ICC Safeguarding Regulations are intended to supplement such laws and regulations. They are not intended, and should not be interpreted, construed or applied, to prejudice or undermine in any way the application of such laws and regulations. Participants must comply with all applicable laws and regulations at all times. Where a Participant who is an employee or contractor of the ICC breaches these ICC Safeguarding Regulations, the ICC may choose to pursue its remedies against him/her under employment law and/or contract law and/or under these ICC Safeguarding Regulations, as it sees fit.
- 2.4 For the avoidance of doubt, following the completion of an ICC Event, the ICC shall continue to have jurisdiction over Participants under these ICC Safeguarding Regulations in respect of any matters that took place in connection with an ICC Event.

ARTICLE 3 – PROHIBITED CONDUCT

Any act or omission that would amount to a breach of Articles 3.1 - 3.4 of these ICC Safeguarding Regulations shall constitute **"Prohibited Conduct"**.

- 3.1 No Participant may (i) engage, or attempt or threaten to engage, in conduct that directly or indirectly harms the physical and/or mental welfare and/or safety of one or more Protected Persons, and/or (ii) pose a risk of harm to the physical and/or mental welfare and/or safety of one or more Protected Persons. Without limitation, Appendix 2 to these ICC Safeguarding Regulations sets out some conduct that might constitute 'harm' for these purposes.
- 3.2 All Participants subject to an ICC investigation under these ICC Safeguarding Regulations, or who may otherwise be asked to assist with any such investigation, shall cooperate, without delay, with the ICC's investigation, unless there is compelling justification as to why he/she is unable or unwilling to cooperate with the ICC's investigation.
- 3.3 No Participant may treat any other Participant or other person in a negative and/or detrimental manner on the ground or belief that such Participant or other person has reported a concern or matter to the ICC and/or assisted the ICC in any manner in relation to any investigation or proceedings brought under these ICC Safeguarding Regulations.
- 3.4 No Participant may make a malicious report to the ICC, or otherwise act in bad faith in relation to matters covered by these ICC Safeguarding Regulations.

ARTICLE 4 – REPORTING AND THE ICC’S POWERS OF INVESTIGATION**NOTE:**

The ICC wants to be presented with any information, from any source, where there is reason to believe that a Participant has harmed or presents a risk of harm to one or more Protected Persons (especially, although not exclusively, in relation to Young Persons and Adults at Risk).

Absent any specific duty on the person making a report outside of these ICC Safeguarding Regulations (for example, any duty owed by a National Cricket Federation to its participants or as an employer), it is not the responsibility of those reporting concerns to the ICC to determine if a Protected Person has been harmed or are otherwise at risk of harm. All concerns should be reported directly to the ICC, in addition to any other appropriate bodies (for example the local police if criminal activity is suspected or in an emergency).

The ICC will support those who wish to make a report, and provide any guidance that may be necessary in relation to the making of a report. In addition to any reporting processes that may from time to time be publicised for specific ICC Events, reports can be made to the ICC in confidence at any time either:

- via email to safeguarding@icc-cricket.com; or
- by telephone on +971 4 382 8800.

- 4.1 Upon receipt of information (from any source) that gives the ICC reasonable ground(s) to suspect that a Participant might have engaged in Prohibited Conduct, the ICC will be entitled to investigate the matter.
- 4.2 In relation to any investigation commenced under these ICC Safeguarding Regulations, the ICC may:
 - 4.2.1 investigate the matter itself; and/or
 - 4.2.2 appoint another person or others, including an independent safeguarding expert (or experts), to assist in relation to its investigation or investigate the matter on the ICC’s behalf.
- 4.3 In relation to any investigation commenced under these ICC Safeguarding Regulations, the ICC (or its appointee) may require any Participant (and request other parties) to:
 - 4.3.1 attend to answer and provide information and/or answer questions by way of interview;
 - 4.3.2 produce documents, information or other material in whatever form held;
 - 4.3.3 undertake a risk assessment by a suitably qualified person appointed by the ICC (or its appointee) in such form as the ICC (or its appointee), at its discretion, considers appropriate; and/or
 - 4.3.4 cooperate in any other manner that might be necessary or desirable for the purposes of the investigation.

ARTICLE 5 – PROVISIONAL SUSPENSION

- 5.1 At any point in time where the ICC General Counsel has reasonable ground(s) to suspect that a Participant has engaged in Prohibited Conduct, the ICC General Counsel may Provisionally Suspend that Participant, for such duration, and on such terms and conditions as he/she considers appropriate, pending final determination of the matter.
- 5.2 The ICC General Counsel will impose a Provisional Suspension only in cases where he/she considers it to be reasonable and proportionate, and taking into account the aims and objectives of these ICC Safeguarding Regulations. Prior to issuing a Provisional Suspension, the ICC General Counsel will consider the following matters:
 - 5.2.1 whether any Protected Person is or may be at risk of harm;
 - 5.2.2 the prospect of any charge(s) under these ICC Safeguarding Regulations being upheld;
 - 5.2.3 the seriousness of the suspected Prohibited Conduct;
 - 5.2.4 whether a Provisional Suspension is necessary or desirable to allow the conduct of any investigation by the ICC, National Cricket Federation, the police or any other relevant authority to proceed unimpeded;
 - 5.2.5 the opinion of any independent safeguarding expert (should the ICC General Counsel choose to seek such an opinion); and
 - 5.2.6 any other circumstances that might be relevant to the individual case.
- 5.3 If the ICC General Counsel issues a Provisional Suspension, the Participant will be promptly notified by the ICC General Counsel. The notification should, unless impracticable for any reason (such as prejudice to an investigation or because of the risk of harm to any person):
 - 5.3.1 set out the reasons why the Provisional Suspension has been imposed;
 - 5.3.2 detail the scope of the Provisional Suspension, i.e., which activities the Participant is prohibited from undertaking (which may be all or some of those activities set out at Article 5.6); and
 - 5.3.3 advise that the Participant may apply to have the Provisional Suspension lifted or varied in accordance with the process described in Article 8.13 et seq.
- 5.4 A Participant subject to a Provisional Suspension may apply to have it lifted or varied. Such an application shall be made in writing and submitted to the ICC General Counsel for the consideration of the Safeguarding Chairperson, to be determined in accordance with Article 8.13 et seq.
- 5.5 A Provisional Suspension will otherwise remain in force pending final determination of the matter.

- 5.6 Unless the terms of a Provisional Suspension are varied in any way, while Provisionally Suspended a Participant may not play, coach, attend, officiate or otherwise participate or be involved in any capacity in any cricket match, event or activity (other than authorised education or rehabilitation programmes) that is authorised, organised, sanctioned, recognised or supported in any way by the ICC, a National Cricket Federation, or any member under the jurisdiction of a National Cricket Federation, or receive accreditation to provide media or other services at any official venue or cricket match.
- 5.7 The ICC may publish and/or share information relating to Provisional Suspensions on a 'need to know' basis with the CEO and/or any other appropriate person of any relevant National Cricket Federation and other relevant third parties, in such form and manner, and to such extent, as it deems necessary for the purposes of enforcement and/or compliance and having due regard for the aims and objectives of these ICC Safeguarding Regulations at all times.
- 5.8 National Cricket Federations shall take all reasonable steps within their powers to give effect to Provisional Suspensions to the extent that they have the jurisdiction, power or ability to do so.

ARTICLE 6 – NOTICE OF CHARGE AND REFERRALS TO THE SAFEGUARDING CHAIRPERSON

- 6.1 If, at the conclusion of an investigation commenced under these ICC Safeguarding Regulations, the ICC General Counsel concludes that the Participant under investigation has a case to answer for Prohibited Conduct, the ICC General Counsel will send a written notice of charge ("**Notice of Charge**") to that Participant, copied to the CEO of the Participant's National Cricket Federation:
- 6.1.1 confirming that a charge(s) is (are) being issued against the Participant under these ICC Safeguarding Regulations and that the matter is being referred to the Safeguarding Chairperson;
 - 6.1.2 detailing the facts and evidence on which the charge(s) is (are) based;
 - 6.1.3 detailing the terms and conditions of any Provisional Suspension (if different to or not already imposed under Article 5);
 - 6.1.4 setting out the sanction and/or risk management measure(s) that the ICC General Counsel considers appropriate in the event that the charge(s) is (are) admitted or upheld; and
 - 6.1.5 requiring the Participant's written response to the charge(s) within 14 (fourteen) days.
- 6.2 A Participant may respond to a Notice of Charge in one of the following ways:
- 6.2.1 to admit the charge(s) and accede to the sanction and/or risk management measure(s) specified in the Notice of Charge;
 - 6.2.2 to admit the charge(s), but indicate an intention to dispute and/or seek to mitigate the proposed sanction and/or risk management measure(s) specified in the Notice of Charge by way of hearing in accordance with Article 8; or

- 6.2.3 to deny the charge(s) and to have the charge(s) and (if the charge(s) is (are) upheld) any appropriate sanction and/or risk management measure(s) determined at a hearing in accordance with Article 8.
- 6.3 In the event that a Notice of Charge is sent to a Participant who was under the age of 18 years when the relevant Prohibited Conduct is alleged to have occurred, the ICC General Counsel may send a copy of the Notice of Charge to the Participant's parent/legal guardian/carer in addition to the Participant's National Cricket Federation.
- 6.4 Following receipt of a response to a Notice of Charge in accordance with Article 6.2.2, the ICC General Counsel may, if he/she deems appropriate, enquire with the Participant as to whether the Participant wishes to have the matter referred to the Safeguarding Chairperson (acting alone) to determine an appropriate sanction and/or risk management measure(s) (if any) without the need for a hearing. The Participant will be required to respond to the ICC General Counsel within 7 (seven) days of the enquiry being sent. In the event that no response to the enquiry is received by the ICC General Counsel within the timeframe, or by any extended timeline granted by the ICC General Counsel, the matter will proceed to be determined in accordance with Article 8. For the avoidance of doubt, in cases where the ICC General Counsel does not consider a matter appropriate for disposal as envisaged by this Article 6.4, the matter will proceed in accordance with Articles 6.6 and 8.
- 6.5 Where the ICC General Counsel and a Participant reach agreement in accordance with Article 6.4, the Safeguarding Chairperson shall give each party an opportunity to make written submissions on the appropriate sanction and/or risk management measure(s), and for each party to comment on the other's submissions, prior to issuing a written, reasoned decision. In such cases, the ICC and Participant will retain the right of appeal under Article 10, save that the appeal shall be limited to a review of the sanction and/or risk management measure(s) imposed by the Safeguarding Chairperson.
- 6.6 Following receipt of a response to a Notice of Charge under Article 6.2.2 or 6.2.3, where the Participant indicates that he/she wants the matter to be determined at a hearing in accordance with Article 8 (and there is no agreement between the Participant and ICC General Counsel as contemplated by Article 6.4), the ICC General Counsel will request that the Safeguarding Chairperson convene a Safeguarding Panel to determine the matters set out in the Notice of Charge.
- 6.7 In the event that no response to the Notice of Charge is received from the Participant within 14 (fourteen) days, or by any extended timeline that the ICC's General Counsel deems appropriate, the Participant will be deemed to have:
- 6.7.1 admitted the charge(s) as specified in the Notice of Charge;
 - 6.7.2 waived his/her entitlement to a hearing; and
 - 6.7.3 acceded to the sanction and/or risk management measure(s) specified in the Notice of Charge.

ARTICLE 7 – ICC SAFEGUARDING GROUP

- 7.1 The ICC will establish a group of individuals who individually shall be eligible to sit on any Safeguarding Panel. The group shall consist of an independent Chairperson appointed by the ICC (“**Safeguarding Chairperson**”) and no fewer than eight other independent safeguarding experts, who will be appointed by the Safeguarding Chairperson, and whose individual and collective experience may be drawn from legal, policing, social work, offender management and/or sport administration backgrounds (collectively, the “**Safeguarding Group**”). The Safeguarding Chairperson will appoint one member of the Safeguarding Group as his/her deputy Chairperson (“**Deputy Safeguarding Chairperson**”).
- 7.2 The primary purpose of the Safeguarding Group and, as convened, the Safeguarding Panel, will be to consider referrals made by the ICC General Counsel under Article 6 in accordance with Article 8, but it may also fulfil such other relevant responsibilities as the ICC may specify from time to time.
- 7.3 The ICC will provide administrative and secretarial support to the Safeguarding Group and any Safeguarding Panel convened from time to time, or otherwise arrange for the provision of such support.

ARTICLE 8 – CONDUCT OF PROCEEDINGS**Appointment of Safeguarding Panels**

- 8.1 Any matter referred to the Safeguarding Chairperson, unless determined in accordance with Article 6.5, shall be determined by a panel consisting of three members of the Safeguarding Group, one acting as Chair (whom shall be a legally qualified member of the Safeguarding Group), each of whom shall be appointed by the Safeguarding Chairperson (“**Safeguarding Panel**”). For the avoidance of doubt, the Safeguarding Chairperson may appoint himself/herself to any Safeguarding Panel, but may not appoint himself/herself and the Deputy Safeguarding Chairperson to the same Safeguarding Panel.
- 8.2 The functions of Safeguarding Panels are:
- 8.2.1 to determine any referral made by the ICC General Counsel under Article 6;
- 8.2.2 to determine any other matter that the ICC General Counsel or the Safeguarding Chairperson may reasonably refer to a Safeguarding Panel.
- 8.3 The Safeguarding Chairperson shall notify both the ICC General Counsel and the Participant of the identity of the Safeguarding Panel that will hear and determine the matter.
- 8.4 If any member of a Safeguarding Panel is for any reason unable, unwilling or unfit to continue to serve on a Safeguarding Panel, the Safeguarding Chairperson shall revoke that member’s appointment and appoint an alternative member from the Safeguarding Group. If the Safeguarding Chairperson is for any reason unable, unwilling or unfit to continue to serve, the Deputy Safeguarding Chairperson will take over the role of Safeguarding Chairperson.
- 8.5 Where a ruling is required in relation to any urgent matter before a Safeguarding Panel has been convened, the Safeguarding Chairperson shall determine that matter alone or he/she may refer that matter to a Safeguarding Panel (once convened).
- 8.6 Where necessary or desirable for the effective conduct of matters arising under these ICC Safeguarding Regulations, the Safeguarding Chairperson may delegate all or some of his/her function(s) to the Deputy Safeguarding Chairperson.
- Conduct of proceedings**
- 8.7 Subject to the discretion of the person appointed as Chair of a Safeguarding Panel to order otherwise for good cause shown by either party (for example, having due regard to the seriousness of the alleged offence, where the alleged offence took place, the costs of attending any hearing), or unless otherwise agreed between the parties, hearings before the Safeguarding Panel shall take place at the ICC’s headquarters in Dubai, United Arab Emirates.
- 8.8 The parties shall be entitled, at their own expense and arrangement, to be represented by legal counsel or any other representative(s) in all proceedings under these ICC Safeguarding Regulations.
- 8.9 As soon as practicable after the formation of the Safeguarding Panel, the Chair shall issue directions to the parties in relation to the procedure and timetable to be followed in the proceedings. Where the Chair deems appropriate, he/she shall hold a directions hearing prior to issuing such directions. In particular, the directions shall:
- 8.9.1 fix the date, time and venue of the hearing;
- 8.9.2 establish a schedule for the exchange of written submissions and evidence in advance of the hearing, including confirmation by the ICC General Counsel of the details of his/her prima facie case, confirmation by the Participant of the details of his/her defence and/or mitigation, and provision for the ICC General Counsel to reply to the Participant’s defence and/or mitigation; and
- 8.9.3 make such order as he/she deems appropriate in relation to the manner and form in which any witness or expert evidence should be produced, provided that:
- 8.9.3.1 a party intending to rely upon the evidence of a witness or expert shall serve a statement or report setting out the proposed evidence of such witness or expert at a date in advance of the hearing that is specified by the Chair; and
- 8.9.3.2 the Safeguarding Panel shall have the power to allow, refuse or limit the evidence or appearance at the hearing of any witness or expert; and
- 8.9.4 make such order as he/she shall deem appropriate in relation to the disclosure of relevant documents and/or other materials in the possession or control of either party.

- 8.10** Where the Safeguarding Panel determines, of its own motion or at the request of the parties, to hold a directions hearing, the hearing may be held in person or by telephone or video link. The non-attendance of any party or his/its representative(s) at the directions hearing, after proper notice of the hearing has been provided, shall not prevent the Chair from proceeding with the meeting in such party's absence, whether or not any written submissions are made by or on behalf of that party.
- 8.11** The Safeguarding Panel shall have all powers necessary for, and incidental to, the discharge of its responsibilities under these ICC Safeguarding Regulations, including (without limitation) the power, whether on the application of a party or of its own motion:
- 8.11.1 to appoint an expert to assist or advise the Safeguarding Panel on a specific issue or issues, such expert to be and remain impartial and independent of the parties, and the costs of such expert to be borne by the parties or in such manner as directed by the Safeguarding Panel;
 - 8.11.2 to expedite or to adjourn, postpone or suspend its proceedings, upon such terms as it shall determine, where fairness so requires;
 - 8.11.3 to extend or abbreviate any time limit;
 - 8.11.4 to conduct such enquiries as appear necessary or expedient in order to ascertain the facts;
 - 8.11.5 to order any party to make any property, document or other material in its possession or under its control available for inspection by the Safeguarding Panel and/or any other party;
 - 8.11.6 to allow one or more third parties to intervene or be joined in the proceedings, to make all appropriate procedural directions in relation to such joinder or intervention, and thereafter to make a single final decision or separate decisions in respect of all parties;
 - 8.11.7 to award interim relief or other conservatory measures on a provisional basis subject to final determination; and
 - 8.11.8 to rule on its own jurisdiction.
- 8.12** The Chair of the Safeguarding Panel may make procedural rulings on his/her own.

Conduct of applications relating to Provisional Suspension

- 8.13** All applications in relation to Provisional Suspensions shall be heard by the Safeguarding Chairperson or Deputy Safeguarding Chairperson acting alone (with all further references to the Safeguarding Chairperson in Articles 8.14 to 8.19 to be construed accordingly). For the avoidance of doubt, Provisional Suspension applications should not be dealt with by any member of the Safeguarding Panel who will determine the relevant matter.
- 8.14** The Safeguarding Chairperson may only lift or vary a Provisional Suspension imposed by the ICC General Counsel under Article 5 if he/she finds that the terms of the Provisional Suspension are unreasonable and/or disproportionate.

- 8.15** Any evidence and submissions of the parties regarding the Provisional Suspension will be made in writing unless the Safeguarding Chairperson so orders, in person or orally by telephone or video link (but there shall otherwise be no right to make oral representations in any manner). The Safeguarding Chairperson shall give each party an opportunity to comment on the other's submissions prior to making a decision in relation to the lifting, varying or upholding of the Provisional Suspension.
- 8.16** In the event that the Safeguarding Chairperson finds that the Provisional Suspension imposed by the ICC General Counsel is unreasonable and/or disproportionate, he/she may lift or vary the Provisional Suspension on such terms as he/she considers are reasonable and proportionate.
- 8.17** In the event that the Safeguarding Chairperson upholds the Provisional Suspension, he/she may specify under which circumstances and/or after which date a further application may be made by the Participant.
- 8.18** In considering any Provisional Suspension issued under these ICC Safeguarding Regulations, the Safeguarding Chairperson may not in the ordinary course of events consider any evidence provided by either party which the other party has not seen and had a reasonable opportunity to respond to. Exceptionally, the ICC General Counsel may however make an application for permission to submit evidence that has not been sent to the Participant where the ICC General Counsel considers that such evidence should not be sent to the Participant because revealing it (or the identity of, or anything which might reveal the identity of any individual named within such evidence) to the Participant may create a risk of harm to any person or persons and/or be unlawful.
- 8.19** The Safeguarding Chairperson may, at his/her discretion, allow or reject an application under Article 8.18 in whole or in part. In the event that the Safeguarding Chairperson allows the evidence to be submitted, he/she shall consider whether a redacted version of the evidence and/or a summary of the evidence can be provided to the Participant.

Hearings

- 8.20** Save for good cause shown by any party, all hearings shall be conducted on a private and confidential basis, attended only by the parties to the proceedings and their representatives, as well as, for good cause shown and with the approval of the Safeguarding Panel, the representatives of any third party with a legitimate interest in the proceedings.
- 8.21** The hearing shall be conducted in English. The Participant shall be entitled to use an interpreter. Any party wishing to rely upon documents written in a language other than English shall produce certified English translations of such documents, and shall bear the cost of any translation.
- 8.22** The procedure to be followed at the hearing shall be at the discretion of the Chair of the Safeguarding Panel, provided always that the hearing is conducted in a fair manner, with a reasonable opportunity provided for each party to present evidence (including the right to call and to question witnesses), address the Safeguarding Panel and present its/his/her case as to both liability and any sanctions and/or risk management measures.
- 8.23** At the beginning of the hearing the Chair shall explain the order of the proceedings that the Safeguarding Panel proposes to adopt.

- 8.24** The Safeguarding Panel shall have discretion as to whether to receive evidence from witnesses in person, by telephone, by video link or in writing, and shall have the right to question a witness and control the questioning of witnesses by a party.
- 8.25** Unless the Safeguarding Panel orders that parties may make submissions in writing only, all parties should attend hearings in person, along with any representative(s). The non-attendance of any party or his representative at the hearing, after notice of the hearing has been provided in accordance with these ICC Safeguarding Regulations, shall not prevent the Safeguarding Panel from proceeding with the hearing in his absence, whether or not written submissions have been made by or on behalf of that party.

Proof and evidence

- 8.26** The burden of proof shall be on the ICC General Counsel in all cases brought under these ICC Safeguarding Regulations and the standard of proof shall be whether the Safeguarding Panel is satisfied on the balance of probabilities that the alleged Prohibited Conduct has been committed.
- 8.27** The following rules of proof shall be applicable:
- 8.27.1 The Safeguarding Panel shall not be bound by rules governing the admissibility of evidence in judicial or other proceedings. Instead, facts may be established by any reliable means, including admissions and circumstantial evidence.
- 8.27.2 The Safeguarding Panel shall have discretion to accept any facts established by a decision of a court or professional disciplinary tribunal of competent jurisdiction that is not the subject of a pending appeal as irrefutable evidence of those facts as against the Participant to whom the decision pertained, unless the Participant establishes that the decision violated principles of natural justice.
- 8.28** The Safeguarding Panel shall determine the manner in which the evidence of any Young Person or Adult at Risk is given (if any), bearing in mind (i) the objective of achieving a fair hearing, (ii) any possible detriment to the welfare of a Young Person or Adult at Risk from giving evidence, and (iii) the possible advantages that the evidence will bring to determine the truth of the matters at hand.
- 8.29** The Safeguarding Panel shall take appropriate steps to improve the quality of the evidence of a Young Person or Adult at Risk and minimise the risk of distress in the provision of such evidence. A Young Person or Adult at Risk should only ever be questioned directly by any party in person if he/she is very clearly capable of doing so and very clearly capable of making that decision for himself/herself.

Decisions

- 8.30** Once the parties have completed their respective submissions, the Safeguarding Panel shall retire to determine in private whether it is satisfied on the evidence, to the required standard, of the issues which are before it for determination. The Safeguarding Panel shall make its decision unanimously or by majority. No member of the Safeguarding Panel may abstain.

- 8.31** The Safeguarding Panel shall announce its decision in writing, with reasons, as soon as possible after the conclusion of the hearing. That written decision will set out and explain:
- 8.31.1 the Safeguarding Panel's findings as to whether any Prohibited Conduct has been committed; and
- 8.31.2 the Safeguarding Panel's findings as to what sanction(s) and/or risk management measure(s) are to be imposed (if any).
- 8.32** The Safeguarding Panel has the power to make a costs order against any party to the hearing in respect of the costs of convening the Safeguarding Panel and of staging the hearing and/or in respect of the costs (legal, expert, travel, accommodation, translation or otherwise) incurred by the parties in relation to the proceedings where it deems it appropriate (for example, but without limitation, where it considers that such party has acted spuriously, frivolously or otherwise in bad faith). If it does not exercise that power, the ICC shall pay the costs of convening the Safeguarding Panel and of staging the hearing, and each party shall bear its own costs (legal, expert, travel, accommodation, translation or otherwise).

ARTICLE 9 – SANCTIONS AND RISK MANAGEMENT MEASURES

- 9.1** Safeguarding Panels may impose such sanction and/or risk management measure(s) as they deem appropriate. However, a Safeguarding Panel should consider the following range of sanctions and risk management measures where a Safeguarding Panel concludes that a Participant has engaged in Prohibited Conduct:
- 9.1.1 a warning as to future conduct;
- 9.1.2 a reprimand;
- 9.1.3 an order requiring a Participant to undertake specific training/ education;
- 9.1.4 an order requiring a Participant to be monitored in specific matters;
- 9.1.5 compensation payments to any person affected by the Prohibited Conduct of such amount as the Safeguarding Panel deems appropriate;
- 9.1.6 a fine in such amount as the Safeguarding Panel deems appropriate;
- 9.1.7 a period of Ineligibility of such duration and on such terms and conditions as the Safeguarding Panel considers appropriate (up to and including indefinite Ineligibility from all cricketing activities).
- 9.2** In determining the appropriate sanction and/or risk management measure(s), the Safeguarding Panel shall take into account the seriousness of the offence, the context of the particular situation, whether the conduct in question was deliberate, reckless, and/or negligent, and any continuing risk the Participant may pose. The Safeguarding Panel may also take into account any mitigating or aggravating factors it considers relevant and appropriate.

- 9.3 The ICC may publish and/or share details of sanctions and risk management measures on a 'need to know' basis, in such form and manner, and to such extent, as it deems necessary for the purposes of enforcement and/or compliance and having due regard for the aims and objectives of these ICC Safeguarding Regulations at all times.
- 9.4 No Participant who is declared Ineligible may, during the period of Ineligibility, play, coach, attend, officiate or otherwise participate or be involved in any capacity in any cricket match, event or activity (other than authorised education or rehabilitation programmes) that is authorised, organised, sanctioned, recognised or supported in any way by the ICC, a National Cricket Federation, or any member under the jurisdiction of a National Cricket Federation, or receive accreditation to provide media or other services at any official venue or cricket match.
- 9.5 Sanctions and risk management measures imposed under these ICC Safeguarding Regulations shall be recognised, enforced, extended and given effect to within their respective jurisdictions by the ICC and National Cricket Federations automatically upon receipt of notice of the same, without the need for further formality.
- 9.6 Equally, the ICC may (in its discretion) recognise and give effect to sanctions and risk management measures (or equivalent sanctions or measures) of National Cricket Federations, or (as the case may be) other sports governing bodies or other relevant authorities in respect of safeguarding matters.

ARTICLE 10 – APPEALS

- 10.1 Decisions made under these ICC Safeguarding Regulations may be challenged solely by way of appeal as set out in this Article 10. Decisions shall remain in effect while under appeal unless any properly convened Safeguarding Appeal Panel orders otherwise.
- 10.2 The only parties who may appeal a decision shall be: (a) the Participant; and (b) the ICC General Counsel.
- 10.3 Any notice to appeal under this Article must be lodged with the ICC's General Counsel within seven (7) days of receipt of the relevant decision, who shall as soon as possible refer the notice to the Safeguarding Chairperson. In all cases, a copy of such notice will also be provided to the National Cricket Federation to which the Participant is affiliated. Thereafter, the following will apply:
- 10.3.1 Within seven (7) days of receipt of a notice to appeal, the Safeguarding Chairperson will appoint three members of the Safeguarding Group to sit as a Safeguarding Appeal Panel ("**Safeguarding Appeal Panel**").
- 10.3.2 The provisions of Article 8, applicable to proceedings before a Safeguarding Panel, shall apply mutatis mutandis (i.e., with changes deemed to have been made as required to reflect the different context) to appeal hearings before the Safeguarding Appeal Panel.

- 10.3.3 Where required in order to do justice (for example to cure procedural errors at the first instance hearing), the Chair of the Safeguarding Appeal Panel may rule that the appeal shall take the form of a re-hearing de novo of the issues raised by the case. In all other cases, the appeal shall not take the form of a de novo hearing but instead shall be limited to a consideration of whether the decision-maker(s):
- 10.3.3.1 conducted the proceedings in a way that was substantially unfair and prejudicial to the appealing party;
- 10.3.3.2 misinterpreted, failed to apply or wrongly applied these ICC Safeguarding Regulations or the applicable law; and/or
- 10.3.3.3 came to a decision no reasonable decision-maker could have come to (whether in respect to liability, sanction and/or risk management measure(s), or any other relevant matter).
- 10.3.4 For the avoidance of doubt, a Safeguarding Appeal Panel may uphold the original decision or issue a new decision that replaces the original decision (which, in the context of sanction and/or risk management measure(s), may mean an 'increase' or 'decrease' to any sanction and/or risk management measure(s) previously imposed).
- 10.3.5 Appeal hearings pursuant to this Article 10 should be completed expeditiously. Save where all parties agree or fairness requires otherwise, the appeal hearing shall be commenced no later than thirty (30) days after the appointment of the Safeguarding Appeal Panel. It shall be open to the Safeguarding Appeal Panel, in its discretion, to determine that the matter (or any part thereof) be dealt with by way of written submissions only.
- 10.3.6 Any decision made by the Safeguarding Appeal Panel under this Article 10, shall be the full, final and complete disposition of the matter and will be binding on all parties. All parties waive irrevocably any right to any other form of appeal, review or recourse by or in any court or judicial authority, insofar as such waiver may validly be made. For the avoidance of doubt, such a waiver extends to any rights that would otherwise arise under sections 45 or 69 of the Arbitration Act 1996.

ARTICLE 11 – MISCELLANEOUS

- 11.1** These ICC Safeguarding Regulations are to be interpreted and applied by reference to their core aim of ensuring the welfare of Protected Persons. Such interpretation and application shall take precedence over any strict legal or technical interpretations that may otherwise be proposed. Any documents that may be published by the ICC from time to time to further the aims of these ICC Safeguarding Regulations (for example policy and guidance documents) may be referred to as interpretative aids.
- 11.2** In the event that any incident or other matter occurs that is not provided for in these ICC Safeguarding Regulations (whether it relates to conduct, jurisdiction, investigation, procedure, sanction and/or risk management measure(s) or otherwise), or if any part of these ICC Safeguarding Regulations is deemed deleted as contemplated by Article 11.8 then the ICC, Safeguarding Chairperson, Deputy Safeguarding Chairperson, Safeguarding Panel, Safeguarding Appeal Panel or any other relevant decision-maker may take such action as considered appropriate in the circumstances, taking into account the specific circumstances of the individual case and the principles of natural justice and fairness.
- 11.3** Minor practical or technical points will not serve to invalidate the procedure or any decisions or findings made under these ICC Safeguarding Regulations, so long as the principles of natural justice and fairness are not infringed.
- 11.4** The ICC may share information obtained pursuant to these ICC Safeguarding Regulations with National Cricket Federations, the police and/or other relevant authorities.
- 11.5** These ICC Safeguarding Regulations are intended to operate on a stand-alone basis. However, in the event that any matter or conduct falling under these ICC Safeguarding Regulations may also fall to be determined under any other relevant ICC rules, regulations or procedures (as may from time to time be in force), or is subject to investigation by the police or another sports governing body (including any National Cricket Federation or sports governing body outside cricket) or other relevant body, or is subject to any other legal/regulatory/disciplinary process, then the ICC, Safeguarding Chairperson, Safeguarding Panel or other relevant decision-maker may at any point temporarily suspend any procedure ongoing under these ICC Safeguarding Regulations. For the avoidance of doubt, in the event that any matter or conduct falling under these ICC Safeguarding Regulations also falls under any other relevant ICC rules, regulations or procedures, the ICC may bring proceedings under those other rules or regulations (regardless of whether proceedings are also brought under these ICC Safeguarding Regulations).
- 11.6** Save to the extent that disclosure and/or publication is provided for in these ICC Safeguarding Regulations, or is otherwise in accordance with the law, all matters considered under these ICC Safeguarding Regulations, will, so far as practicable, be regarded as confidential and used only for the purposes of these ICC Safeguarding Regulations.

- 11.7** These ICC Safeguarding Regulations are governed by English law. The English courts shall have exclusive jurisdiction to issue relief in aid of the arbitration agreement contained within these ICC Safeguarding Regulations and/or to hear and determine challenges to any final decision issued under these ICC Safeguarding Regulations.
- 11.8** If any part of these ICC Safeguarding Regulations is ruled to be invalid, unenforceable or illegal for any reason, that part will be deemed deleted, and the rest of these ICC Safeguarding Regulations will remain in full force and effect.
- 11.9** Neither the ICC, nor any person employed by or appointed to assist the ICC, will be liable to any party for any act or omission unless it is actuated by malice or bad faith.
- 11.10** These ICC Safeguarding Regulations shall come into effect on 1 May 2019 ("Effective Date"). The ICC may amend these ICC Safeguarding Regulations from time to time. Such amendments will come into effect on the date specified by the ICC. The substantive provisions of these ICC Safeguarding Regulations shall not apply retrospectively to matters arising before the Effective Date (but, for the avoidance of doubt, a Participant may be considered to pose a risk of harm as a consequence of conduct that took place prior to the Effective Date).

APPENDIX 1

DEFINITIONS

Adult at Risk. Any person aged 18 or older who is engaged in activities in connection with an ICC Event (whether as a Participant or otherwise) and who is, or may be, vulnerable to or unable to protect himself or herself against harm or the risk of it (whether generally or a result of circumstances in which they find themselves at the relevant time)

Deputy Safeguarding Chairperson. As defined in Article 7.1.

Effective Date. As defined in Article 11.10.

ICC. The International Cricket Council or its designee.

ICC Events. Means each of the following, and each match played as part of the following (men's and women's, as applicable): (a) the ICC Cricket World Cup, together with any qualifying events thereto; (b) the ICC Twenty20 World Cup, together with any qualifying events thereto; (c) the ICC Men's World Test Championship Final, (d) the ICC Under 19 Cricket World Cup, together with any qualifying events thereto; (e) the ICC Intercontinental Cup; (f) any successor to or replacement for any of the foregoing events, as specified by the ICC and (g) any other match or event organised or sanctioned by the ICC from time to time to which the ICC deems it appropriate that these ICC Safeguarding Regulations should apply.

ICC General Counsel. The person appointed by the ICC from time to time to act as the ICC's General Counsel (or his/her designee).

ICC Official. Any individual bound by the ICC Code of Ethics.

ICC Safeguarding Regulations. These ICC Safeguarding Regulations promulgated by the ICC on the Effective Date.

Ineligibility. The Participant being barred from participating in cricketing activities, as set out more specifically in Article 9.4.

Match Referee. Any independent person who is appointed by the ICC or any other relevant party as the official match referee for a match during an ICC Event, whether such Match Referee carries out his/her functions remotely or otherwise.

National Cricket Federation. A national or regional entity that is a member of or is recognised by the ICC as the entity governing the sport of cricket in a country (or collective group of countries associated for cricket purposes).

Notice of Charge. As defined in Article 6.1.

Participant. As defined in Article 2.1.

Pitch Curator. Any individual who acts as a pitch curator or groundsman at any stadium or venue affiliated (whether through a club, franchise, county, province or otherwise) to any National Cricket Federation.

Player Agent. Any individual who acts in any way in the capacity of agent, representative, adviser or otherwise in relation to the negotiation, arrangement, registration of execution of any employment or commercial agreement for a cricketer, irrespective of whether such individual is registered or licensed to perform such activity within a National Cricket Federation or not.

Prohibited Conduct. As defined in Article 3.

Protected Person(s). Any person(s) engaged in activities in connection with an ICC Event (whether as a Participant or otherwise), including (but not limited to) Young Persons and Adults at Risk.

Provisional Suspension. The Participant being temporarily barred from participating in cricketing activities, as set out more specifically in Article 5.6.

Safeguarding Appeal Panel. As defined in Article 10.3.1.

Safeguarding Chairperson. As defined in Article 7.1. The Safeguarding Chairperson shall be a legally qualified person of sufficient qualification and experience.

Safeguarding Group. As defined in Article 7.1.

Safeguarding Panel. As defined in Article 8.1.

Umpire. Any umpire (including any on-field umpire, television umpire, third or fourth umpire) who is appointed by the ICC or any other relevant party to officiate in an ICC Event.

Umpire Support Personnel. Any technical official (for example, and without limitation, any official with responsibility for operating the communication equipment for Umpires and Match Referees during an ICC Event) or umpire coach who is appointed by the ICC or any other relevant party to support the Umpires and/or Match Referees in their appointments to any match during an ICC Event.

Young Person. Any person under the age of 18 years engaged in activities in connection with an ICC Event (whether as a Participant or otherwise).

APPENDIX 2

NON-EXCLUSIVE GUIDANCE AS TO CONDUCT THAT MIGHT CONSTITUTE 'HARM' FOR THE PURPOSES OF THE ICC SAFEGUARDING REGULATIONS

'Harm' is not a narrow concept and whether or not harm has occurred, or the risk of harm exists, will inevitably be a fact-specific analysis. However, in general terms, 'harm' means ill-treatment or the impairment of health, welfare or development. Harm can be caused directly and indirectly, including by text, e-mail and various social media and other communication platforms.

Abusive behaviour is always harmful. There are various forms of abusive behaviour, including (but not limited to) the following:

Physical abuse

Physical abuse may involve hitting, shaking, throwing, poisoning, burning or scalding, biting, drowning, suffocating or otherwise causing physical harm.

Emotional abuse

Emotional abuse is persistent emotional ill-treatment such as to cause severe and persistent adverse effects on another's emotional development or state. It may involve, by way of example:

- conveying to someone that he/she is worthless, inadequate, or valued only insofar as they meet the needs of another person;
- not giving a person opportunities to express his/her views, deliberately silencing him/her or 'making fun' of what he/she says or how they communicate;
- undue or repeated criticism, name-calling, sarcasm, harassment, or discrimination;
- inappropriate expectations being imposed upon a person;
- preventing a person's normal social interaction;
- a person seeing or hearing the ill-treatment of another;
- bullying someone, causing him/her frequently to feel frightened, embarrassed or in danger; and
- exploitation or corruption of a person.

Sexual abuse

Sexual abuse may involve, by way of example, sexual harassment, forcing or inappropriately enticing someone to take part in sexual activities against their will, whether or not the other person is aware of what is happening.

Sexual abuse may involve physical contact, and it may also involve non-contact activities such as, without limitation, grooming, exposing oneself, involving another person in looking at, or in the production of, sexual images, or encouraging someone to behave in a sexually inappropriate way.

OTHER ICC REGULATIONS

OTHER ICC REGULATIONS

The following rules, agreements, regulations and documents are available on the ICC website (www.icc-cricket.com) or on request from enquiry@icc-cricket.com.

- Code of Ethics
- Duckworth Lewis Stern Method
- ICC Membership Criteria
- ICC Code of Conduct for Match Officials and Match Officials Support Personnel
- ICC Memorandum and Articles
- ICC Men's Test Match Playing Conditions
- World Cricket League Playing Conditions
- World Cricket League Championship Playing Conditions
- Pitch and Outfield Monitoring Process
- Player Eligibility Regulations
- Players' and Match Officials' Areas – Minimum Standards
- ICC Regulations on Sanctioning of Events
- ICC Classification of Official Cricket
- Standard ICC Intercontinental Cup Playing Conditions
- ICC Anti-Discrimination Policy for International Cricket
- Terms of Reference for the Code of Conduct Commission
- Terms of Reference of the Disputes Resolution Committee
- Terms of Reference – Associate Members' Meetings
- Terms of Reference – Audit Committee
- Terms of Reference – Women's Committee
- Terms of Reference – HR and Remuneration Committee
- Terms of Reference – Finance and Commercial Affairs Committee
- Terms of Reference – Development Committee
- Terms of Reference – Chief Executive's Committee
- Terms of Reference – Cricket Committee
- Terms of Reference – Nominations Committee
- Women's Test Match Playing Conditions
- Women's One Day International Playing Conditions